



# User's Guide

## Multimedia Projector

**EB-585Wi**

**EB-575Wi**

**EB-585W**

**EB-575W**

**EB-580**



**EB-570**

## Notations Used in This Guide





- **Safety indications**

The documentation and the projector use graphical symbols to show how to use the projector safely.

The indications and their meaning are as follows. Make sure you understand them properly before reading the guide.

 <b>Warning</b>	This symbol indicates information that, if ignored, could possibly result in personal injury or even death due to incorrect handling.
 <b>Caution</b>	This symbol indicates information that, if ignored, could possibly result in personal injury or physical damage due to incorrect handling.

- **General information indications**

<b>Attention</b>	Indicates procedures which may result in damage or injury if sufficient care is not taken.
	Indicates additional information and points which may be useful to know regarding a topic.
	Indicates a page where detailed information regarding a topic can be found.
	Indicates that an explanation of the underlined word or words in front of this symbol appears in the glossary of terms. See the "Glossary" section of the "Appendix".  "Glossary" <a href="#">p.188</a>
[Name]	Indicates the name of the buttons on the remote control or the control panel. Example: [Esc] button
Menu Name	Indicates Configuration menu items. Example: Select <b>Brightness</b> from <b>Image</b> . <b>Image - Brightness</b>

## Notations Used in This Guide ..... 2

### Introduction

---

#### Projector Features ..... 8

- Interactive Features (Easy Interactive Function) (EB-585Wi/EB-575Wi only) . . . . . 8
- Enabling Projection from a Short Distance . . . . . 8
- Connecting to a Network and Projecting Images from the Computer's Screen . . . . . 8
- Enhanced Security Functions . . . . . 9
- Enlarge and Project Your Files with the Document Camera . . . . . 9

#### Part Names and Functions ..... 11

- Front/Side . . . . . 11
- Top/Side . . . . . 12
- Interface . . . . . 13
- Base . . . . . 14
  - Attaching the Feet (only Models with Feet Supplied) . . . . . 15
- Control Panel . . . . . 16
- Remote Control . . . . . 17
  - Replacing the Remote Control Batteries . . . . . 19
  - Remote Control Operating Range . . . . . 20
- Interactive Pen (EB-585Wi/EB-575Wi only) . . . . . 20
  - Replacing the Battery for the Interactive Pen . . . . . 21
  - Replacing the Tip of the Interactive Pen . . . . . 22
- Pen Tray (EB-585Wi/EB-575Wi only) . . . . . 23

### Preparing the Projector

---

#### Installing the Projector ..... 25

- Installation Methods . . . . . 25
  - When Using the Interactive Features (EB-585Wi/EB-575Wi only) . . . . . 26

#### Connecting Equipment ..... 28

- Connecting a Computer . . . . . 28
- Connecting a Smartphone or Tablet Device . . . . . 30

- Connecting Image Sources . . . . . 31
- Connecting USB Devices . . . . . 34
- Connecting a Microphone . . . . . 36
- Connecting External Equipment . . . . . 37
- Connecting a LAN Cable . . . . . 39
- Installing the Optional Wireless LAN Unit . . . . . 40
- Connecting Multiple Projectors (EB-585Wi/EB-575Wi only) . . . . . 41

### Basic Usage

---

#### Projecting Images ..... 44

- Getting Ready to Project . . . . . 44
- Automatically Detect Input Signals and Change the Projected Image (Source Search) . . . . . 45
- Switching to the Target Image Using the Remote Control . . . . . 46
- Projecting with USB Display . . . . . 47
  - System Requirements . . . . . 47
  - Connecting for the First Time . . . . . 48
  - Uninstalling . . . . . 49

#### Adjusting Projected Images ..... 50

- Correcting Keystone Distortion . . . . . 50
  - H/V-Keystone . . . . . 50
  - Quick Corner . . . . . 51
- Adjusting the Image Size . . . . . 53
- Adjusting the Position of the Image (Image Shift) . . . . . 53
- Adjusting the Vertical Position of the Image (Models Supplied with the Feet only) . . . . . 54
  - Raising the Height of the Image . . . . . 54
  - Lowering the Height of the Image . . . . . 54
- Adjusting the Horizontal Position of the Image (Models Supplied with the Feet only) . . . . . 54
- Correcting the Focus . . . . . 55
- Adjusting the Volume . . . . . 57
- Selecting the Projection Quality (Selecting Color Mode) . . . . . 58
- Setting Auto Iris . . . . . 58
- Changing the Aspect Ratio of the Projected Image . . . . . 59

Changing Methods . . . . . 59  
 Changing the Aspect Mode (EB-585Wi/EB-585W/EB-575Wi/EB-575W only) . . . . 59  
 Changing the Aspect Mode (EB-580/EB-570 only) . . . . . 61

## Using the Interactive Features (EB-585Wi/EB-575Wi only)

**Interactive Feature Modes . . . . . 63**  
 Drawing on a Projected Image (Annotation Mode) . . . . . 64  
 Using the Projected Screen as a Whiteboard (Whiteboard Mode) . . . . . 65  
 Controlling Computer Features from a Projected Screen (Computer Interactive Mode) . . . . . 66  
     Computer Interactive Mode System Requirements . . . . . 66  
     Using Computer Interactive Mode . . . . . 66  
     Easy Interactive Driver System Requirements (OS X only) . . . . . 69  
     Installing Easy Interactive Driver on OS X . . . . . 69

**Using the Interactive Pens . . . . . 70**  
 Pen Calibration . . . . . 71  
     Calibrating Automatically . . . . . 72  
     Calibrating Manually . . . . . 73  
 Adjusting the Pen Operation Area . . . . . 75

**Interacting with the Screen . . . . . 77**  
 Switching the Interactive Mode . . . . . 77  
 Annotation Mode and Whiteboard Mode Toolbars . . . . . 78  
     Selecting Line Width and Color . . . . . 79  
     Selecting Whiteboard Templates . . . . . 80  
 Projector Control Toolbar . . . . . 80  
     Selecting Network Device Display from the Projector Control Toolbar . . . . . 81

**Using the Interactive Features over a Network . . . . . 83**  
 Precautions When Connecting to a Projector on a Different Subnet . . . . . 83

**Windows Pen Input and Ink Tools . . . . . 85**  
 Enabling Windows Pen Input and Ink Features . . . . . 85  
 Using Windows Pen Input and Ink Features . . . . . 86

## Useful Functions

**Projection Functions . . . . . 88**  
 Projecting Images Stored on a USB Storage Device (PC Free) . . . . . 88  
     Specifications for Files that Can Be Projected Using PC Free . . . . . 88  
     PC Free Examples . . . . . 88  
     PC Free Operating Methods . . . . . 89  
     Projecting the Selected Images or Movies . . . . . 90  
     Projecting Image Files in a Folder in Sequence (Slideshow) . . . . . 91  
     Image File Display Settings and Slideshow Operation Settings . . . . . 92  
 Hiding the Image and Sound Temporarily (A/V Mute) . . . . . 93  
 Freezing the Image (Freeze) . . . . . 93  
 Pointer Function (Pointer) . . . . . 94  
 Enlarging Part of the Image (E-Zoom) . . . . . 94  
 Using the Remote Control to Operate the Mouse Pointer (Wireless Mouse) . . . . . 95  
 Saving a User's Logo . . . . . 97  
 Saving User Pattern . . . . . 99

**Security Functions . . . . . 101**  
 Managing Users (Password Protection) . . . . . 101  
     Kinds of Password Protection . . . . . 101  
     Setting Password Protection . . . . . 101  
     Entering the Password . . . . . 102  
 Restricting Operation (Control Panel Lock) . . . . . 103  
 Anti-Theft Lock . . . . . 104  
     Installing the Wire Lock . . . . . 104

**Monitoring and Controlling . . . . . 105**  
 About EasyMP Monitor . . . . . 105  
     Message Broadcasting . . . . . 105  
 Changing Settings Using a Web Browser (Web Control) . . . . . 105  
     Projector Setup . . . . . 105  
     Displaying the Web Control Screen . . . . . 106  
     Displaying the Web Remote Screen . . . . . 106  
 Using the Mail Notification Function to Report Problems . . . . . 107  
     Reading Error Notification Mail . . . . . 108  
 Management Using SNMP . . . . . 108  
 ESC/VP21 Commands . . . . . 109



Command List ..... 109  
 Cable Layouts ..... 109  
 About PJLink ..... 110  
 About Crestron RoomView® ..... 111  
 Operating a Projector from Your Computer ..... 111

## Configuration Menu

**Using the Configuration Menu ..... 116**

**List of Functions ..... 117**

Configuration Menu Table ..... 117  
 Network Menu ..... 118  
 Image Menu ..... 119  
 Signal Menu ..... 120  
 Settings Menu ..... 122  
 Extended Menu ..... 123  
     Easy Interactive Function Setting Items ..... 126  
 Network Menu ..... 127  
     Notes on Operating the Network Menu ..... 128  
     Soft Keyboard Operations ..... 128  
     Basic Menu ..... 129  
     Wireless LAN Menu ..... 130  
     Security Menu ..... 131  
     Wired LAN Menu ..... 132  
     Mail Menu ..... 133  
     Others Menu ..... 134  
     Reset Menu ..... 135  
 ECO Menu ..... 135  
 Info Menu (Display only) ..... 136  
 Reset Menu ..... 137

**Performing Batch Setup for Multiple Projectors ..... 138**

## Troubleshooting

**Using the Help ..... 140**

**Problem Solving ..... 141**

Reading the Indicators ..... 141  
 When the Indicators Provide No Help ..... 145  
 Problems Relating to Images ..... 146  
     No Images Appear ..... 146  
     Moving Images Are Not Displayed (only the Moving Image Portion Turns Black) ..... 147  
     Projection Stops Automatically ..... 147  
     The Message Not supported Is Displayed ..... 147  
     The Message No Signal Is Displayed ..... 148  
     Images Are Fuzzy, Out of Focus, or Distorted ..... 148  
     Interference or Distortion Appear in Images ..... 149  
     The Mouse Cursor Flickers (only when Projecting USB Display) ..... 150  
     The Image Is Truncated (Large) or Small, or the Aspect Is Not Suitable ..... 150  
     Image Colors Are Not Right ..... 151  
     Images Appear Dark ..... 151  
 Problems when Projection Starts ..... 152  
     The Projector Does Not Turn on ..... 152  
 Problems with the Interactive Features (EB-585Wi/EB-575Wi only) ..... 152  
     Cannot Draw on the Projected Screen ..... 152  
     Cannot Operate a Computer from the Projected Screen after Connecting to the Computer ..... 153  
     The Message An error occurred in the Easy Interactive Function. Is Displayed ..... 153  
     Computer's Mouse Does Not Work Correctly ..... 153  
     The Interactive Pen Does Not Work ..... 154  
     The Response Time for the Interactive Pen Is Slow (only when Projecting USB Display) ..... 154  
     The Dot Moves Automatically or Does Not Move to the Next Position during Calibrating Manually ..... 155  
 Other Problems ..... 155  
     No Sound Can Be Heard or the Sound Is Faint ..... 155  
     No Sound Can Be Heard from the Microphone ..... 156  
     There Is Noise in the Audio (only when Projecting USB Display) ..... 156  
     The Remote Control Does Not Work ..... 156



I Want to Change the Language for Messages and Menus . . . . . 157  
 Mail Is Not Received even if an Error Occurs with the Projector . . . . . 157  
 Cannot Change Settings Using a Web Browser . . . . . 158

**About Event ID . . . . . 159**

**Maintenance**

---

**Cleaning . . . . . 161**  
 Cleaning the Projector's Surface . . . . . 161  
 Cleaning the Projection Window . . . . . 161  
 Cleaning the Obstacle Sensor . . . . . 161  
 Cleaning the Air Filter . . . . . 162

**Replacing Consumables . . . . . 165**

Replacing the Lamp . . . . . 165  
 Lamp Replacement Period . . . . . 165  
 How to Replace the Lamp . . . . . 166  
 Resetting the Lamp Hours . . . . . 169  
 Replacing the Air Filter . . . . . 169  
 Air Filter Replacement Period . . . . . 169  
 How to Replace the Air Filter . . . . . 169

**Appendix**

---

**Optional Accessories and Consumables . . . . . 174**

Optional Accessories . . . . . 174  
 Consumables . . . . . 174

**Screen Size and Projection Distance . . . . . 175**

Projection Distance (for EB-585Wi/EB-585W/EB-575Wi/EB-575W) . . . . . 175  
 Projection Distance (for EB-580/EB-570) . . . . . 176

**Supported Monitor Displays . . . . . 178**

Supported Resolutions . . . . . 178  
 Computer Signals (Analog RGB) . . . . . 178

Component Video . . . . . 178  
 Composite Video . . . . . 178  
 HDMI Input Signal . . . . . 178  
 MHL Input Signal . . . . . 179

**Specifications . . . . . 180**

Projector General Specifications . . . . . 180

**Appearance . . . . . 186**

**Glossary . . . . . 188**

**General Notes . . . . . 190**

Wireless Telegraphy Act Regulations . . . . . 190  
 About Notations . . . . . 190  
 General Notice: . . . . . 191



# Introduction

This chapter explains the projector's features and the part names.

## Interactive Features (Easy Interactive Function) (EB-585Wi/EB-575Wi only)

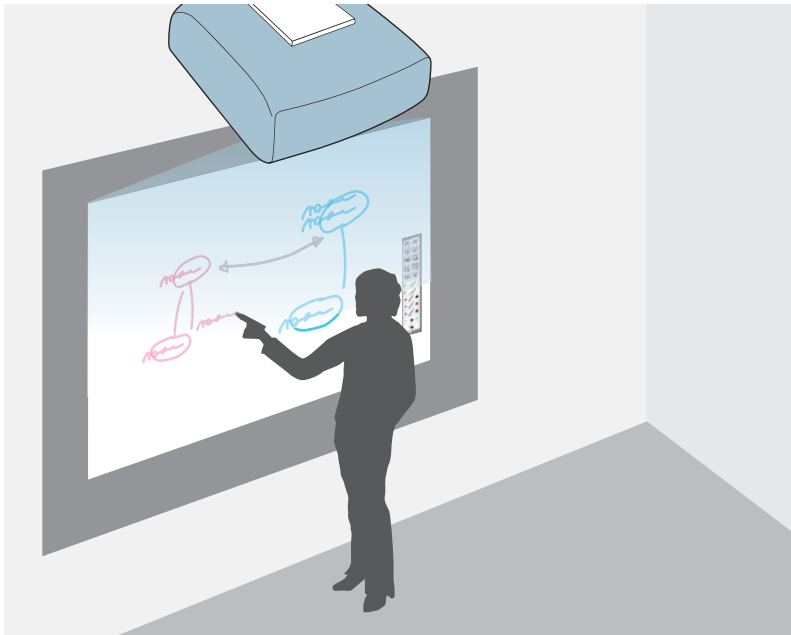

You can perform the following operations with the interactive pen.

- Use the projected screen as a whiteboard
- Draw on content projected from a computer
- Operate a computer from the projected screen
- Operate the projector from the projected screen
- Select devices on the projected screen that have been connected to the network using the supplied EasyMP Multi PC Projection
- Use the interactive features over a network using the supplied EasyMP Network Projection or the optional Quick Wireless

☛ "Using the Interactive Features (EB-585Wi/EB-575Wi only)" [p.62](#)

## Enabling Projection from a Short Distance

You can project large images from a short distance without having to move the projector away from the screen. By mounting the projector on a ceiling or wall, you can minimize shadows cast on the screen even when you are standing near it and avoid being dazzled by the projected light.

☛ "Screen Size and Projection Distance" [p.175](#)

## Connecting to a Network and Projecting Images from the Computer's Screen

You can perform the following operations using EasyMP Network Projection and EasyMP Multi PC Projection found on the supplied EPSON Projector Software CD-ROM.

- Sharing the projector over a network

By using EasyMP Network Projection, you can connect the projector to a network and share it with multiple computers. This allows you to project images and documents from any of the computers without changing cables. You can also project from one computer to multiple projectors.

☛ [EasyMP Network Projection Operation Guide](#)





- Projecting multiple computer screens at the same time

By using EasyMP Multi PC Projection, you can project up to four screens at the same time from a computer on the network, or from smartphones or tablet devices on which Epson iProjection is installed.

☛ [EasyMP Multi PC Projection Operation Guide](#)

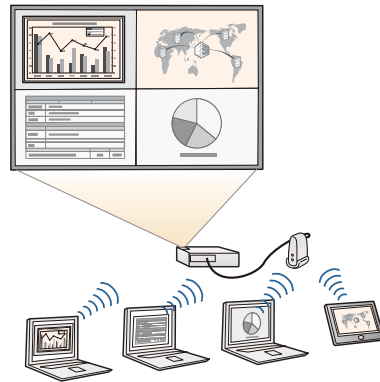

You can perform the following operations using optional products and applications.

- Wirelessly projecting your computer's screen

By installing the optional wireless LAN unit, you can project a computer screen over a network.

☛ "Installing the Optional Wireless LAN Unit" [p.40](#)



- Connecting to a computer with Quick Wireless easily

By simply connecting the optional Quick Wireless Connection USB Key to a computer, you can automatically perform network settings for a wireless LAN connection, and project the computer's screen.

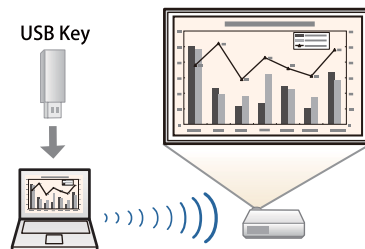

- Projecting images from portable devices over a network

If Epson iProjection is installed on your smartphone or tablet device, you can wirelessly project data from the device. You can download Epson iProjection for free from the App Store or from Google play. Any fees incurred when communicating with the App Store or Google play are the responsibility of the customer.



## Enhanced Security Functions

- **Password Protect to restrict and manage users**

By setting a password you can restrict who can use the projector.

☛ "Managing Users (Password Protection)" [p.101](#)

- **Control Panel Lock restricts button operation on the control panel**

You can use this to prevent people changing projector settings without permission at events, in schools, and so on.

☛ "Restricting Operation (Control Panel Lock)" [p.103](#)

- **Equipped with various anti-theft devices**

The projector is equipped with the following types of anti-theft security devices.

- Security slot
- Security cable installation point
- ☛ "Anti-Theft Lock" [p.104](#)

## Enlarge and Project Your Files with the Document Camera

You can project paper documents and objects using the optional Document Camera. By connecting to a computer and using the software supplied, you can make full use of the projector's capabilities.



☛ "Optional Accessories" [p.174](#)

## Front/Side

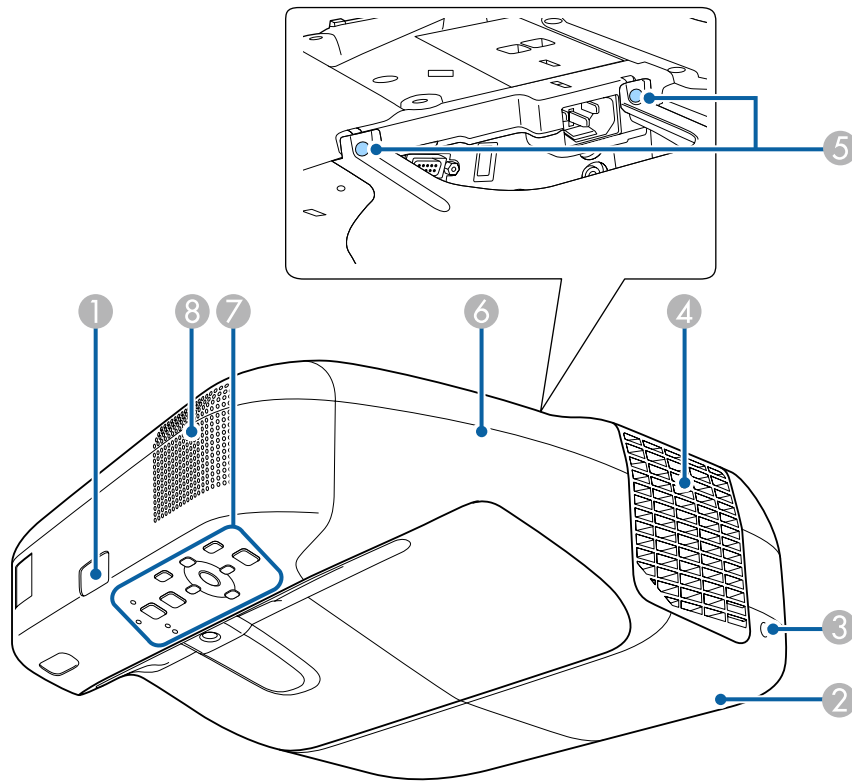

Name	Function
① Remote receiver	Receives signals from the remote control.
② Lamp cover	Open when replacing the projector's lamp. ☛ "Replacing the Lamp" p.165
③ Lamp cover fixing screw	Screw to fix the lamp cover in place. ☛ "Replacing the Lamp" p.165

Name	Function
④ Air exhaust vent	Exhaust vent for air used to cool the projector internally.  <div style="border: 1px solid black; padding: 5px;"> <p><b>⚠ Caution</b></p> <p>While projecting, do not put your face or hands near the air exhaust vent, and do not place objects that may become warped or damaged by heat near the vent. Hot air from the air exhaust vent could cause burns, warping, or accidents to occur.</p> </div>
⑤ Cable cover fixing screws	Screws to fix the cable cover in place.
⑥ Cable cover	Loosen the two screws and open the cover when connecting cables for external devices or installing the wireless LAN unit.
⑦ Control panel	Operates the projector. ☛ "Control Panel" p.16
⑧ Speaker	Outputs audio.

### Top/Side

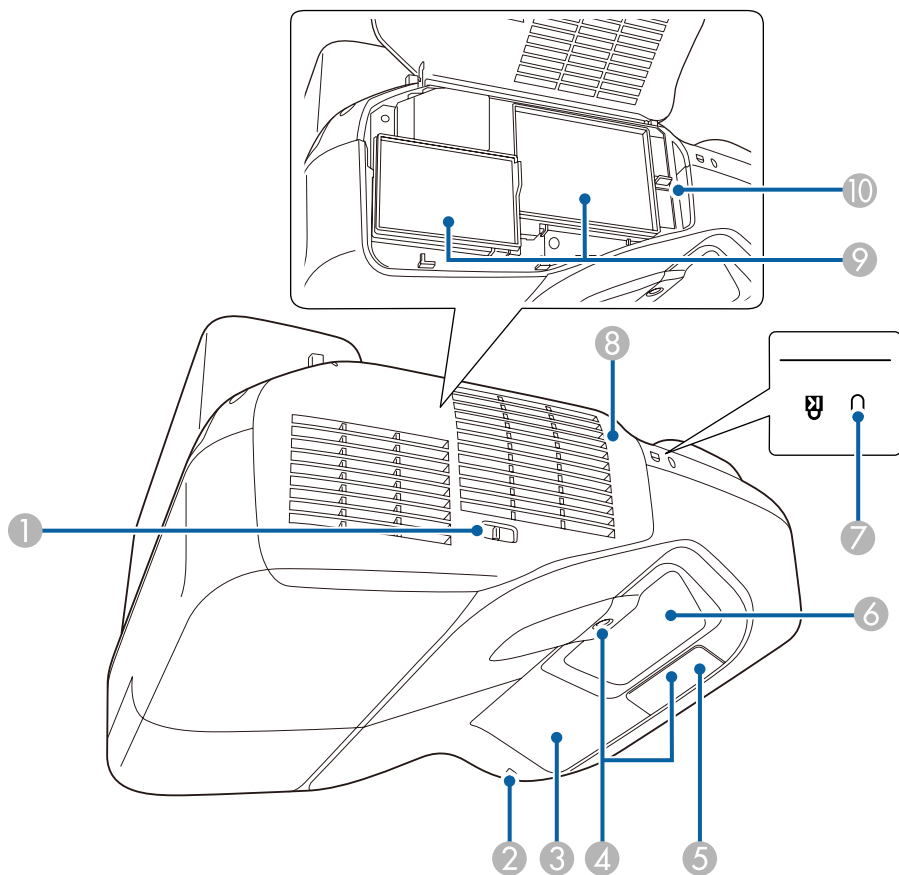

Name	Function
① <b>Air filter cover open/close lever</b>	Opens and closes the air filter cover.
② <b>Wireless LAN indicator</b>	Indicates the access status to the optional wireless LAN unit.

Name	Function
③ <b>Easy Interactive Function receiver</b> (EB-585Wi/EB-575Wi only)	Receives signals from the interactive pen. ☛ "Using the Interactive Features (EB-585Wi/EB-575Wi only)" p.62
④ <b>Obstacle sensor</b>	Detects obstacles that are interfering with the projection area. ☛ "Cleaning the Obstacle Sensor" p.161
⑤ <b>Remote receiver</b>	Receives signals from the remote control.
⑥ <b>Projection window</b>	Projects images. <div style="border: 1px solid black; padding: 5px; margin-top: 10px;"> <p><b>⚠ Warning</b></p> <ul style="list-style-type: none"> <li>Do not look into the projection window while projecting.</li> <li>Do not place any objects or put your hand near the projection window. It could cause burns, fire, or the object to warp because this area reaches a high temperature due to the concentrated projection light.</li> </ul> </div>
⑦ <b>Security slot</b>	The security slot is compatible with the Microsaver Security System manufactured by Kensington. ☛ "Anti-Theft Lock" p.104
⑧ <b>Air filter cover</b>	Open when changing the air filter or operating the focus lever.
⑨ <b>Air intake vent (air filter)</b>	Takes in air to cool the projector internally. ☛ "Cleaning the Air Filter" p.162 ☛ "Replacing the Air Filter" p.169
⑩ <b>Focus lever</b>	Adjusts the image focus. Open the air filter cover to operate.

## Interface

The following ports are available under the cable cover.

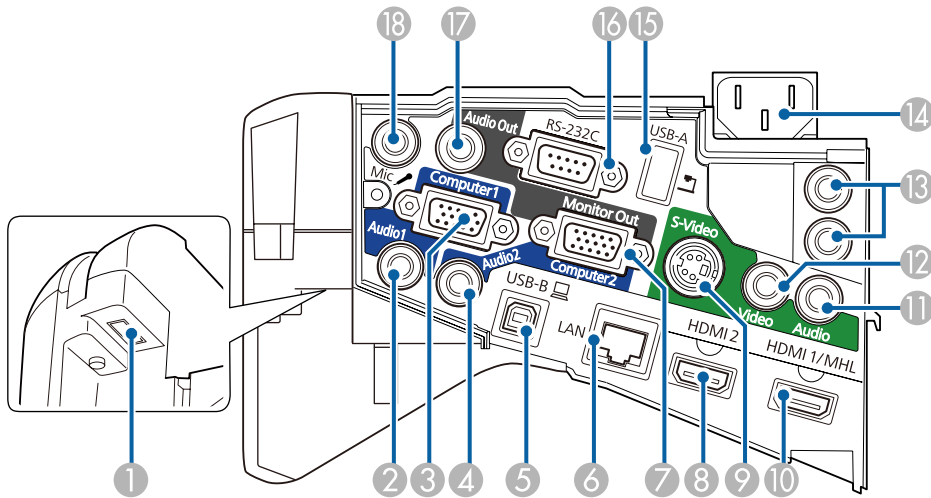

Name	Function
1 <b>Wireless LAN unit installation section</b>	Install the optional Wireless LAN unit. ☛ "Installing the Optional Wireless LAN Unit" p.40
2 <b>Audio1 port</b>	Inputs audio from equipment connected to the Computer1 port.
3 <b>Computer1 port</b>	Inputs image signals from a computer and component video signals from other video sources.
4 <b>Audio2 port</b>	<ul style="list-style-type: none"> <li>Inputs audio from equipment connected to the Computer2 port.</li> <li>Inputs audio from other devices when projecting images from the device connected to the USB-A port.</li> </ul>

Name	Function
5 <b>USB-B port</b>	<ul style="list-style-type: none"> <li>Connects the projector to a computer via the supplied or a commercially available USB cable, and projects the images on the computer. ☛ "Projecting with USB Display" p.47</li> <li>Connects the projector to a computer via the supplied or a commercially available USB cable to use the Wireless Mouse function. ☛ "Using the Remote Control to Operate the Mouse Pointer (Wireless Mouse)" p.95</li> <li>Connects the projector to a computer via the supplied USB cable to use the interactive pen as a mouse (EB-585Wi/EB-575Wi only). ☛ "Controlling Computer Features from a Projected Screen (Computer Interactive Mode)" p.66</li> </ul>
6 <b>LAN port</b>	Connects a LAN cable to connect to a network.
7 <b>Monitor Out/Computer2 input ports</b>	<ul style="list-style-type: none"> <li>When <b>Monitor Out Port</b> is set to <b>Monitor Out</b> from the Configuration menu, analog RGB signals input from the Computer1 port are output to an external monitor. You cannot output signals input from other ports or component video signals.</li> <li>When <b>Monitor Out Port</b> is set to <b>Computer2</b> from the Configuration menu, image signals from a computer and component video signals from other video sources are input.</li> </ul>
8 <b>HDMI2 port</b>	Inputs video signals from HDMI compatible video equipment and computers. This projector is compatible with <b>HDCP</b> ▶▶.
9 <b>S-Video port</b>	For S-video signals from video sources.
10 <b>HDMI1/MHL input port</b>	<ul style="list-style-type: none"> <li>Inputs video signals from HDMI compatible video equipment and computers. This projector is compatible with <b>HDCP</b>▶▶.</li> <li>Inputs signals from smartphones and tablet devices that support <b>MHL</b>▶▶ (Mobile High-definition Link).</li> </ul>

Name	Function
11 <b>Audio port</b>	Inputs audio from equipment connected to the S-Video port or the Video port.
12 <b>Video port</b>	Inputs composite video signals from video sources.
13 <b>SYNC IN/OUT port (EB-585Wi/EB-575Wi only)</b>	When using the interactive features in the same room as multiple versions of the same projector, you need to connect the optional remote control cable set (ELPKC28) to the projectors. When the cable set is connected, the interactive pen operates smoothly. ☛ "Connecting Multiple Projectors (EB-585Wi/EB-575Wi only)" <a href="#">p.41</a>
14 <b>Power inlet</b>	Connects the power cord to the projector. ☛ "Getting Ready to Project" <a href="#">p.44</a>
15 <b>USB-A port</b>	<ul style="list-style-type: none"> <li>Connects a USB memory device or a digital camera, and projects images in PC Free. ☛ "Projecting Images Stored on a USB Storage Device (PC Free)" <a href="#">p.88</a></li> <li>Connects the optional Document Camera.</li> </ul>
16 <b>RS-232C port</b>	When controlling the projector from a computer, connect it to the computer with an RS-232C cable. This port is for control use and should not normally be used. ☛ "ESC/VP21 Commands" <a href="#">p.109</a>
17 <b>Audio Out port</b>	Outputs audio from the currently projected image or the Mic port to an external speaker.
18 <b>Mic port</b>	Inputs audio from the microphone. ☛ "Connecting a Microphone" <a href="#">p.36</a>

## Base

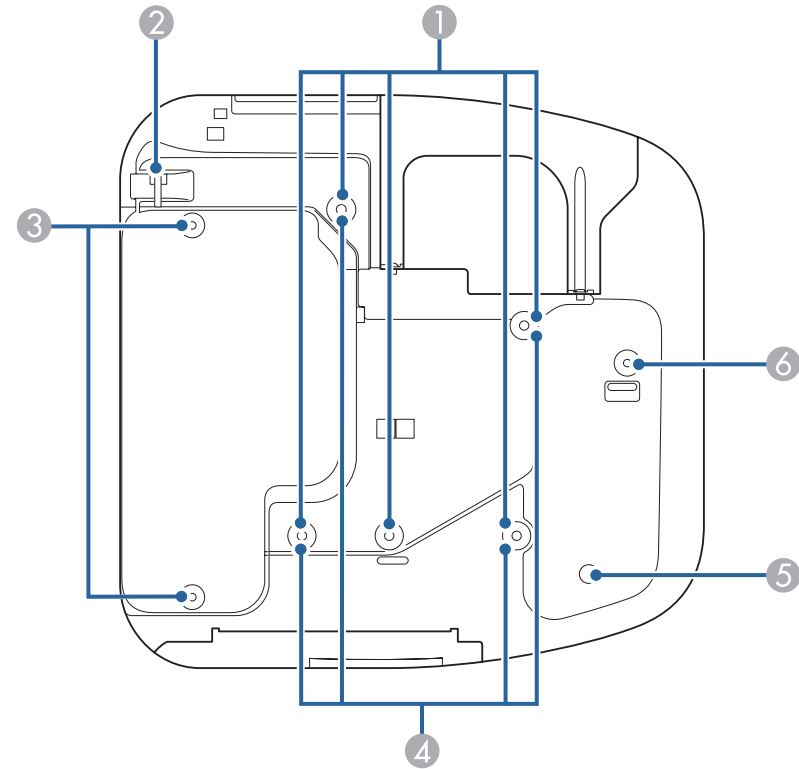

Name	Function
1 <b>Ceiling mount fixing points (five points)</b>	Attach the optional Ceiling mount here when suspending the projector from a ceiling. ☛ "Installing the Projector" <a href="#">p.25</a> ☛ "Optional Accessories" <a href="#">p.174</a>

	Name	Function
2	<b>Security cable installation point</b>	Pass a commercially available wire lock through here and lock it in place. Do not pass drop-prevention wires through here when mounting the projector on a wall or suspending it from a ceiling. ☛ "Installing the Wire Lock" p.104
3	<b>Rear foot fixing points (two points)</b>	Attach the feet when using the projector on a surface such as a desk. (Only models with feet supplied) ☛ "Attaching the Feet (only Models with Feet Supplied)" p.15
4	<b>Wall mount fixing points (four points)</b>	Attach the supplied or optional setting plate when mounting on a wall. ☛ <i>Installation Guide</i> ☛ "Optional Accessories" p.174
5	<b>Illumination sensor</b>	Detects the brightness of the surroundings, and automatically adjusts the brightness of the screen. Set <b>Brightness Control</b> to <b>Auto</b> from the Configuration menu. ☛ <b>ECO - Brightness Control</b> p.135
6	<b>Front foot fixing point</b>	Attach the foot with a spacer when using the projector on a surface such as a desk. (Only models with feet supplied) ☛ "Attaching the Feet (only Models with Feet Supplied)" p.15

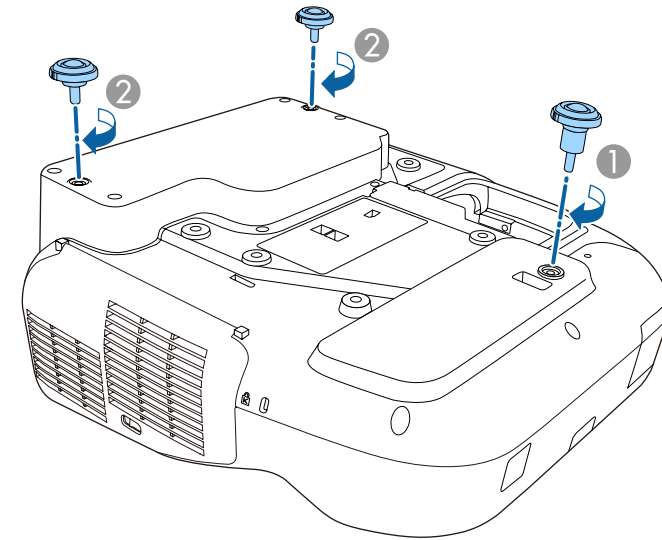

- 1 Insert the foot with the spacer into the front foot fixing point.
- 2 Insert the rear feet (x2) into the foot fixing points.

## Attaching the Feet (only Models with Feet Supplied)

Insert the feet into the foot fixing points.

## Control Panel

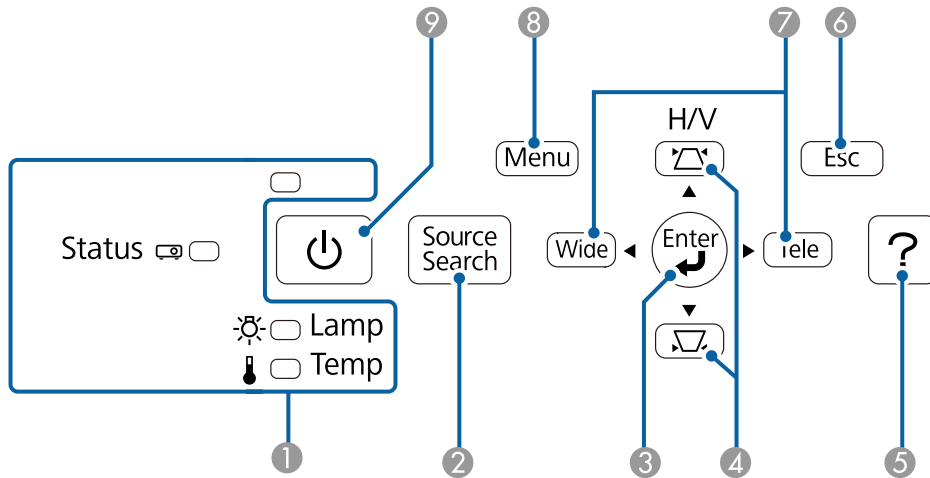

Name	Function
1 <b>Indicators</b>	Indicates the projector's status using color, and by being lit or flashing. ☛ "Reading the Indicators" p.141
2 <b>[Source Search] button</b>	Switches to the image from the input port where video signals are being input. ☛ "Automatically Detect Input Signals and Change the Projected Image (Source Search)" p.45
3 <b>[Enter] button</b> [↵]	<ul style="list-style-type: none"> <li>When the Configuration menu or the Help screen is displayed, it accepts and enters the current selection and moves to the next level.</li> <li>If pressed while projecting analog RGB signals from Computer1 port or Computer2 port, you can automatically optimize Tracking, Sync., and Position.</li> </ul>

Name	Function
4 <b>[△][▽] button</b>	<ul style="list-style-type: none"> <li>Performs keystone correction. ☛ "H/V-Keystone" p.50</li> <li>If pressed when the Configuration menu or the Help screen is displayed, these buttons select menu items and setting values. ☛ "Using the Configuration Menu" p.116 ☛ "Using the Help" p.140</li> </ul>
5 <b>[Help] button</b>	Displays and closes the help screen which shows you how to deal with problems if they occur. ☛ "Using the Help" p.140
6 <b>[Esc] button</b>	<ul style="list-style-type: none"> <li>Stops the current function.</li> <li>If pressed when the Configuration menu is displayed, it moves to the previous menu level. ☛ "Using the Configuration Menu" p.116</li> </ul>
7 <b>[Tele]/[Wide] buttons</b>	<ul style="list-style-type: none"> <li>Adjusts the size of the projection screen. Press the [Tele] button to reduce the size of the projection screen and press the [Wide] button to increase the size of the projection screen.</li> <li>Corrects keystone distortion in the horizontal direction when the Keystone screen is displayed. ☛ "H/V-Keystone" p.50</li> <li>If pressed when the Configuration menu or the Help screen is displayed, these buttons select menu items and setting values. ☛ "Using the Configuration Menu" p.116 ☛ "Using the Help" p.140</li> </ul>
8 <b>[Menu] button</b>	Displays and closes the Configuration menu. ☛ "Using the Configuration Menu" p.116
9 <b>[Power] button</b> [⏻]	Turns the projector power on or off. ☛ "Getting Ready to Project" p.44



## Remote Control

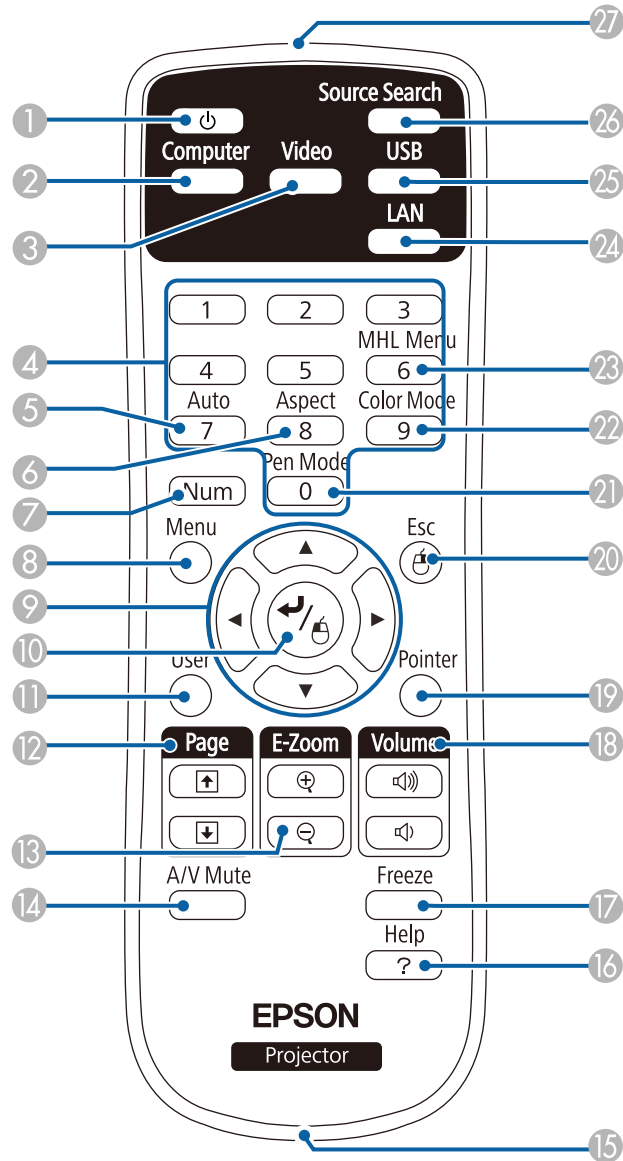

Name	Function
① [Power] button [⏻]	Turns the projector power on or off. ☛ "Getting Ready to Project" p.44
② [Computer] button	Each time you press the button, the input changes between images from the Computer1 port and the Computer2 port.
③ [Video] button	Each time the button is pressed, the image cycles through the S-Video, Video, HDMI1/MHL, and HDMI2 ports.
④ Numeric buttons	<ul style="list-style-type: none"> <li>Enter the Password. ☛ "Setting Password Protection" p.101</li> <li>Use this button to enter numbers in <b>Network</b> settings from the Configuration menu.</li> </ul>
⑤ [Auto] button	If pressed while projecting analog RGB signals from Computer1 port or Computer2 port, you can automatically optimize Tracking, Sync., and Position.
⑥ [Aspect] button	Each time the button is pressed, the aspect mode changes. ☛ "Changing the Aspect Ratio of the Projected Image" p.59
⑦ [Num] button	Hold down this button and press the numeric buttons to enter passwords and numbers. ☛ "Setting Password Protection" p.101
⑧ [Menu] button	Displays and closes the Configuration menu. ☛ "Using the Configuration Menu" p.116



Name	Function
<p>9</p> <p><b>button</b></p>	<ul style="list-style-type: none"> <li>When the Configuration menu or Help screen is displayed, pressing these buttons selects menu items and setting values.                             <ul style="list-style-type: none"> <li>"Using the Configuration Menu" <a href="#">p.116</a></li> </ul> </li> <li>When projecting in PC Free, pressing these buttons displays the previous/next image, rotates the image, and so on.                             <ul style="list-style-type: none"> <li>"Projecting Images Stored on a USB Storage Device (PC Free)" <a href="#">p.88</a></li> </ul> </li> <li>During Wireless Mouse function, the mouse pointer moves in the direction of the button that was pushed.                             <ul style="list-style-type: none"> <li>"Using the Remote Control to Operate the Mouse Pointer (Wireless Mouse)" <a href="#">p.95</a></li> </ul> </li> </ul>
<p>10</p> <p><b>[Enter] button</b> [↵]</p>	<ul style="list-style-type: none"> <li>When the Configuration menu or the Help screen is displayed, it accepts and enters the current selection and moves to the next level.                             <ul style="list-style-type: none"> <li>"Using the Configuration Menu" <a href="#">p.116</a></li> </ul> </li> <li>Acts as a mouse's left button when using the Wireless Mouse function.                             <ul style="list-style-type: none"> <li>"Using the Remote Control to Operate the Mouse Pointer (Wireless Mouse)" <a href="#">p.95</a></li> </ul> </li> </ul>
<p>11</p> <p><b>[User] button</b></p>	<p>Select any frequently used item from the Configuration menu items, and assign it to this button. By pressing the [User] button, the assigned menu item selection/adjustment screen is displayed, allowing you to make one-touch settings/adjustments.</p> <ul style="list-style-type: none"> <li>"Settings Menu" <a href="#">p.122</a></li> </ul> <p>The following item is assigned by default.</p> <ul style="list-style-type: none"> <li>For EB-585Wi/EB-575Wi: <b>Auto Calibration</b></li> <li>For EB-585W/EB-580/EB-575W/EB-570: <b>Power Consumption</b></li> </ul>

Name	Function
<p>12</p> <p><b>[Page] buttons</b> [⏪][⏩]</p>	<p>Changes pages in files such as PowerPoint files when using the following projection methods.</p> <ul style="list-style-type: none"> <li>When using the Wireless Mouse function                             <ul style="list-style-type: none"> <li>"Using the Remote Control to Operate the Mouse Pointer (Wireless Mouse)" <a href="#">p.95</a></li> </ul> </li> <li>When using USB Display                             <ul style="list-style-type: none"> <li>"Projecting with USB Display" <a href="#">p.47</a></li> </ul> </li> <li>When connecting to a network</li> </ul> <p>When projecting images using PC Free, pressing these buttons displays the previous/next image file.</p>
<p>13</p> <p><b>[E-Zoom] buttons</b> [⏪][⏩]</p>	<p>Enlarges or reduces the image without changing the projection size.</p> <ul style="list-style-type: none"> <li>"Enlarging Part of the Image (E-Zoom)" <a href="#">p.94</a></li> </ul>
<p>14</p> <p><b>[A/V Mute] button</b></p>	<ul style="list-style-type: none"> <li>Turns the video and audio on or off.                             <ul style="list-style-type: none"> <li>"Hiding the Image and Sound Temporarily (A/V Mute)" <a href="#">p.93</a></li> </ul> </li> <li>You can change the Projection mode as follows by pressing the button for about five seconds.                             <ul style="list-style-type: none"> <li><b>Front ↔ Front/Upside Down</b></li> <li><b>Rear ↔ Rear/Upside Down</b></li> </ul> </li> </ul>
<p>15</p> <p><b>Strap attachment hole</b></p>	<p>Allows you to attach a commercially available strap to the remote control.</p>
<p>16</p> <p><b>[Help] button</b></p>	<p>Displays and closes the help screen which shows you how to deal with problems if they occur.</p> <ul style="list-style-type: none"> <li>"Using the Help" <a href="#">p.140</a></li> </ul>
<p>17</p> <p><b>[Freeze] button</b></p>	<p>Pauses or resumes image playback.</p> <ul style="list-style-type: none"> <li>"Freezing the Image (Freeze)" <a href="#">p.93</a></li> </ul>
<p>18</p> <p><b>[Volume] buttons</b> [⏪][⏩]</p>	<p>[⏪] Decreases the volume. [⏩] Increases the volume.</p> <ul style="list-style-type: none"> <li>"Adjusting the Volume" <a href="#">p.57</a></li> </ul>
<p>19</p> <p><b>[Pointer] button</b></p>	<p>Displays the on-screen pointer.</p> <ul style="list-style-type: none"> <li>"Pointer Function (Pointer)" <a href="#">p.94</a></li> </ul>

Name	Function
20 [Esc] button	<ul style="list-style-type: none"> <li>Stops the current function.</li> <li>If pressed when the Configuration menu is displayed, it moves to the previous level.                             <ul style="list-style-type: none"> <li>"Using the Configuration Menu" p.116</li> </ul> </li> <li>Acts as a mouse's right button when using the Wireless Mouse function.                             <ul style="list-style-type: none"> <li>"Using the Remote Control to Operate the Mouse Pointer (Wireless Mouse)" p.95</li> </ul> </li> </ul>
21 [Pen Mode] button	<p>Changes between operating the computer or drawing using the interactive pen.</p> <ul style="list-style-type: none"> <li>"Using the Interactive Features (EB-585Wi/EB-575Wi only)" p.62</li> </ul>
22 [Color Mode] button	<p>Each time the button is pressed, the color mode changes.</p> <ul style="list-style-type: none"> <li>"Selecting the Projection Quality (Selecting Color Mode)" p.58</li> </ul>
23 [MHL Menu] button	<p>Displays the settings menu for the device linked to the projector's MHL port.</p>
24 [LAN] button	<p>Switches to the image from the network connected device.</p>
25 [USB] button	<p>Each time the button is pressed, it cycles through the following images:</p> <ul style="list-style-type: none"> <li>USB Display</li> <li>Images from the device connected to the USB-A port</li> </ul>
26 [Source Search] button	<p>Switches to the image from the input port where video signals are being input.</p> <ul style="list-style-type: none"> <li>"Automatically Detect Input Signals and Change the Projected Image (Source Search)" p.45</li> </ul>
27 Remote control light-emitting area	<p>Outputs remote control signals.</p>

## Replacing the Remote Control Batteries

If the remote control becomes unresponsive or inoperable after it has been used for some time, the batteries may have reached the end of their service life. When this happens, replace them with new batteries. Obtain two AA size manganese or alkaline batteries. You cannot use other batteries except for the AA size manganese or alkaline.

### Attention

Make sure you read the following manual before handling the batteries.

 [Safety Instructions](#)

- 1 Remove the battery cover. While pushing the battery cover catch, lift the cover up.

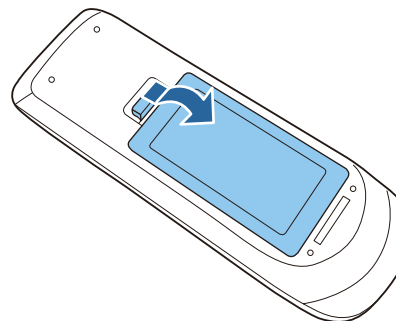

- 2 Replace the old battery with a new battery. Slide the batteries in negative side first.

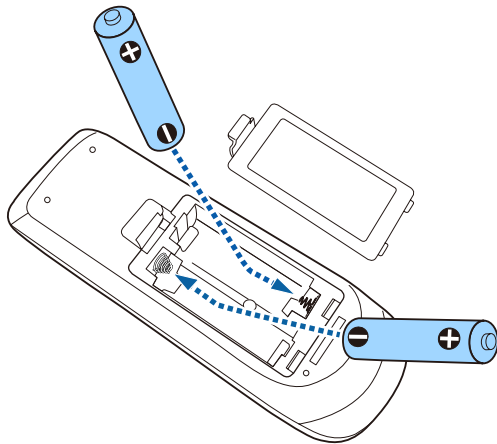

### Caution

Check the positions of the (+) and (-) marks inside the battery holder to ensure the battery is inserted the correct way.

If the batteries are not used correctly, they could explode or leak causing a fire, injury, or damage to the product.

- 3 Reattach the battery cover.  
Press the battery cover until it clicks into place.

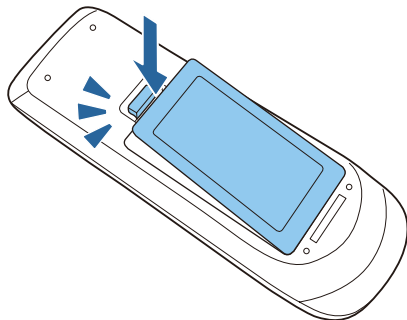

## Remote Control Operating Range

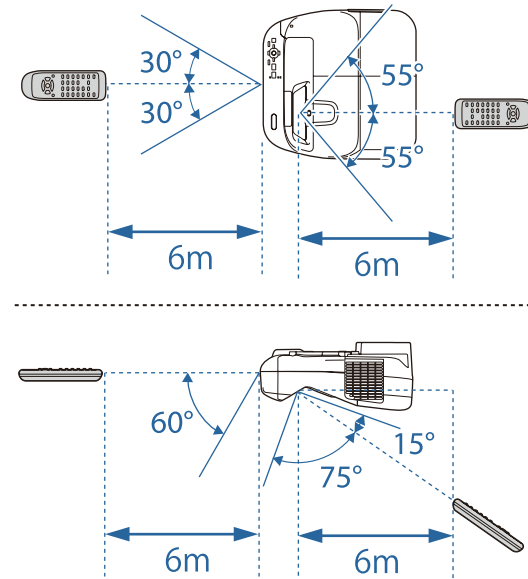

## Interactive Pen (EB-585Wi/EB-575Wi only)

There are two types of interactive pens with different colored bottom sections. You cannot use interactive pens with the same colored bottom sections at the same time.

 "Optional Accessories" [p.174](#)

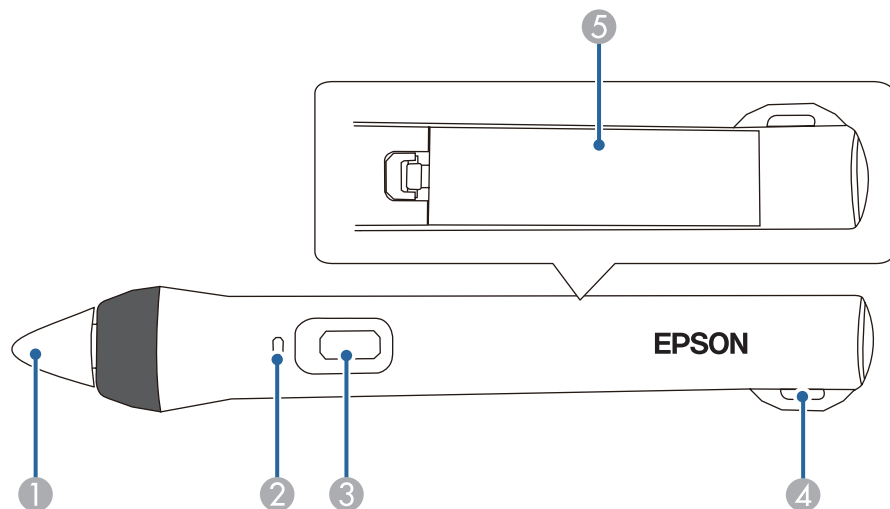

Name	Function
1 Pen tip	<ul style="list-style-type: none"> <li>• Turn on the interactive pen. When turned on, it takes approximately one second before the interactive pen is operational.</li> <li>• Hold the pen close to the projected screen, and press to use.</li> </ul> <p>☛ "Using the Interactive Features (EB-585Wi/EB-575Wi only)" p.62</p> <p>☛ "Optional Accessories" p.174</p>
2 Battery light	<p>Press the button on the side of the pen to indicate the remaining battery power.</p> <ul style="list-style-type: none"> <li>• When the battery is charged, the light is lit green until you release the button.</li> <li>• When the battery is running low, the light flashes green until you release the button.</li> <li>• Does not light when the battery is exhausted. Change the battery.</li> </ul> <p>☛ "Replacing the Battery for the Interactive Pen" p.21</p>

Name	Function
3 Button	<ul style="list-style-type: none"> <li>• Turn on the interactive pen. When turned on, it takes approximately one second before the interactive pen is operational.</li> <li>• Press the button to switch the tip function between pen and eraser while drawing.</li> <li>• Press the button to perform a right-click operation while using the pen as a mouse.</li> </ul>
4 Attachment for optional strap or cord	Allows you to attach a commercially available strap.
5 Battery cover	<p>Open this cover when replacing the battery.</p> <p>☛ "Replacing the Battery for the Interactive Pen" p.21</p>



The interactive pen turns off automatically after 20 minutes of inactivity.

To use the pen again, tap the pen tip or press the button on the side to turn on the power.

### Replacing the Battery for the Interactive Pen

When you press the button, the battery light on the interactive pen lights or flashes. Does not light or flash when the battery is exhausted. When the light no longer lights or flashes, replace the battery. Use one of the following types of battery. Other chargeable batteries cannot be used.

- AA size manganese battery
- AA size alkaline manganese battery
- enloop®\*(HR-3UTG/HR-3UTGA/HR-3UTGB/BK-3MCC)

\* enloop® is a registered trademark of the Panasonic Group.

#### Attention

Make sure you read the following manual before handling batteries.

☛ [Safety Instructions](#)

- 1** Remove the battery cover.  
While pushing the battery cover catch, lift the cover up.

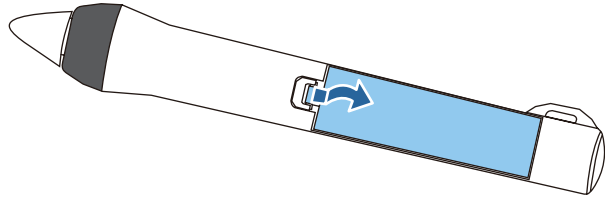

- 2** Replace the old battery with a new battery.  
Slide the batteries in negative side first.

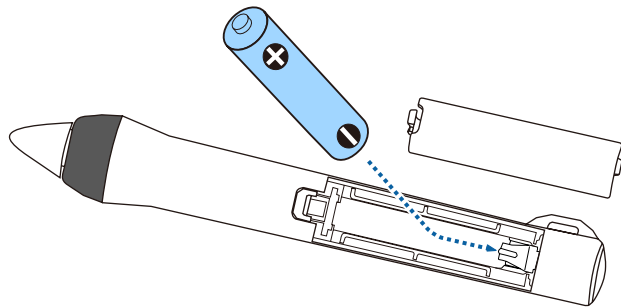

## Caution

Check the positions of the (+) and (-) marks inside the battery holder to ensure the battery is inserted the correct way.

If the batteries are not used correctly, they could explode or leak causing a fire, injury, or damage to the product.

- 3** Replace the battery cover.  
Press the battery cover until it clicks into place.

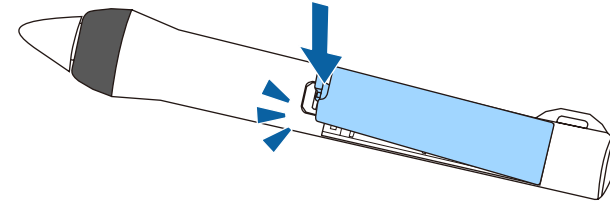

## Replacing the Tip of the Interactive Pen

Replace the tip of the interactive pen when it is worn.

 "Optional Accessories" p.174

- 1** Turn the tip of the pen to remove it.

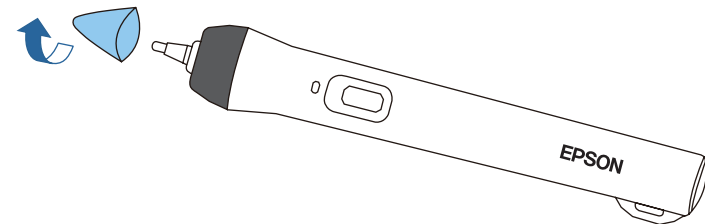

- 2** Turn the new tip to attach it.

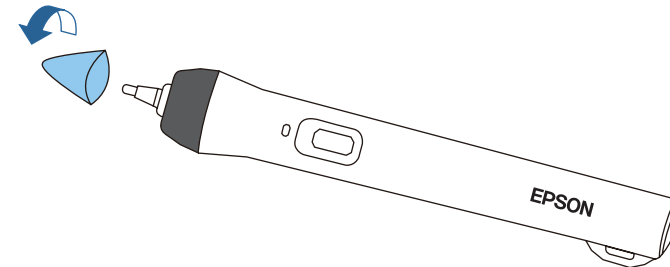

## Pen Tray (EB-585Wi/EB-575Wi only)

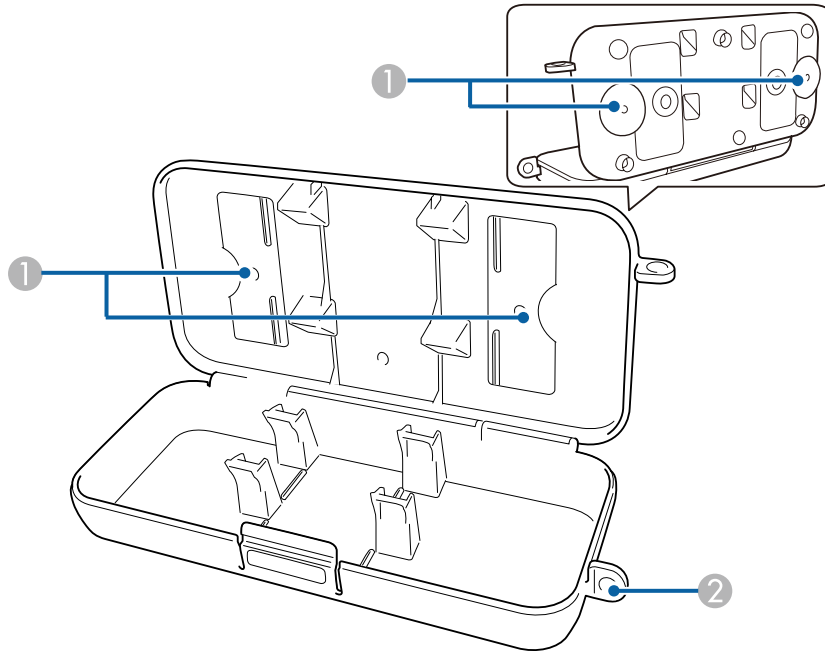

Name	Function
① Fixing points	Attach the pen tray to a whiteboard or wall.
② Security hole	Pass a commercially available lock through here.



It is recommended that the pen tray be tightened with two commercially available M5 bolts.



# Preparing the Projector

This chapter explains how to install the projector and connect projection sources.



## Installation Methods

The projector supports the following six different installation methods. Install the projector according to the installation location.

Turn the projector off when installing the projector or changing the installation method. Turn the power back on after completing installation.

### Warning

- A special method of installation is required when suspending the projector from a wall or ceiling. If it is not installed correctly, it could fall causing an accident and injury.
- If you use adhesives on the wall mount plate fixing points or the ceiling mount fixing points to prevent the screws from loosening, or if you use things such as lubricants or oils on the projector, the projector case may crack causing it to fall from its mount. This could cause serious injury to anyone under the mount and could damage the projector. When installing or adjusting the mount, do not use adhesives to prevent the screws from loosening and do not use lubricant or oil and so on.
- Do not cover the projector's air intake vent or air exhaust vent. If either of the vents are covered, the internal temperature could rise and cause a fire.
- Do not use the projector in a location subject to combustible or explosive gas. The projector may catch fire because of the high temperature of the lamp inside the projector.



- We recommend using a smooth, board type screen without any unevenness. If the projection screen is uneven, there may be distortions in the projected image.
- Distortions may occur in the projected image depending on the material of the screen and the installation method.
- When mounting the projector on a wall or ceiling, or placing the projector vertically, make sure you use the correct tools for the installation method.
  - ☛ "Optional Accessories" [p.174](#)
- The default Projection setting is **Front/Upside Down**. You can change to other Projection settings from the Configuration menu.
  - ☛ **Extended - Projection** [p.123](#)
- You can change the Projection setting as follows by pressing down the [A/V Mute] button on the remote control for about five seconds.  
**Front↔Front/Upside Down**  
**Rear↔Rear/Upside Down**

- Mount the projector on a wall or ceiling and project images from in front of a screen. (Front/Upside Down projection)

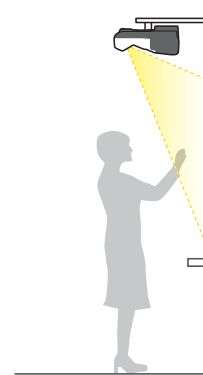

- Mount the projector on a wall or ceiling and project images from behind a translucent screen. (Rear/Upside Down projection)

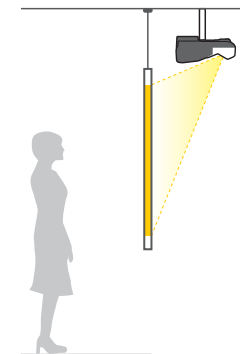

- Project images from in front of the screen. (Front projection)

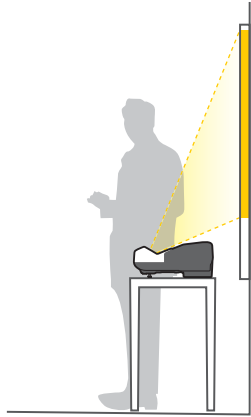

- Project images from behind a translucent screen. (Rear projection)

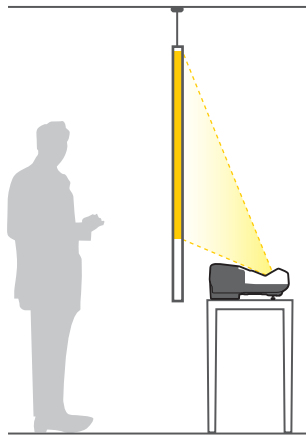

Attach the feet when using the projector on a surface such as a desk.

☛ "Attaching the Feet (only Models with Feet Supplied)" p.15

- Place the projector vertically and project images from in front of the screen. (Front/Upside Down projection)

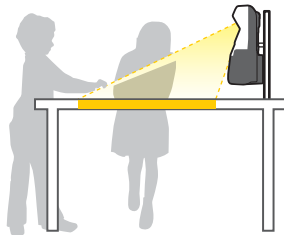

- Place the projector vertically and project images from behind the screen (Rear/Upside Down projection)

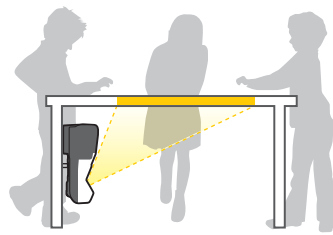

## When Using the Interactive Features (EB-585Wi/EB-575Wi only)

Project from in front of the screen when using the interactive features. Set Projection to **Front/Upside Down** or **Front**.

### Attention

The interactive features operates by infrared communication. Note the following points when installing the projector.

- Make sure there is no strong light or sunlight shining on the Easy Interactive Function receiver, the projection screen, the projector itself, or the rear of the projector.
- Do not install the projector in direct sunlight through a window. This could cause the interactive features to malfunction.
- Install the projector so that the Easy Interactive Function receiver is not too close to fluorescent lights. If the surrounding area is too bright, the interactive features may not operate correctly.
- If there is any dust stuck to the Easy Interactive Function receiver, it could interfere with infrared communication and you may not be able to use the features normally. Clean the receiver if it is dirty.  
☛ "Cleaning" p.161
- Do not put paint or any stickers on the cover of the Easy Interactive Function receiver.
- When using the interactive features, do not use an infrared remote control or microphone in the same room. The interactive pen could malfunction.
- Do not use devices that generate powerful noise, such as rotary devices or transformers, near the projector. You may not be able to operate the interactive features.



- When using the interactive features, install so that the projected screen is a rectangle without any distortion.
- When using the interactive features in the same room as multiple projectors, interactive pen operations may become unstable. In this situation, connect the optional remote control cable set (ELPKC28) to the projectors, and change **Sync of Projectors** to **Wired** from the Configuration menu.
  - ☛ "Connecting Multiple Projectors (EB-585Wi/EB-575Wi only)"  
[p.41](#)
  - ☛ **Extended - Easy Interactive Function - Advanced - Sync of Projectors** [p.126](#)

The port name, location, and connector orientation differ depending on the source being connected.

---

## Connecting a Computer

To project images from a computer, connect the computer using one of the following methods.

① ② **When using the optional computer cable**

Connect the computer's display output port to the projector's Computer1 or Computer2 port.

You can output audio from the projector's speaker by connecting the computer's audio output port to the projector's Audio1 or Audio2 port using a commercially available audio cable.

③ **When using the supplied or a commercially available USB cable**

Connect the computer's USB port to the projector's USB-B port.

Audio from the computer is output from the projector with the projected image.

④ **When using a commercially available HDMI cable**

Connect the computer's HDMI port to the projector's HDMI1/MHL or HDMI2 port.

Audio from the computer is output from the projector with the projected image.

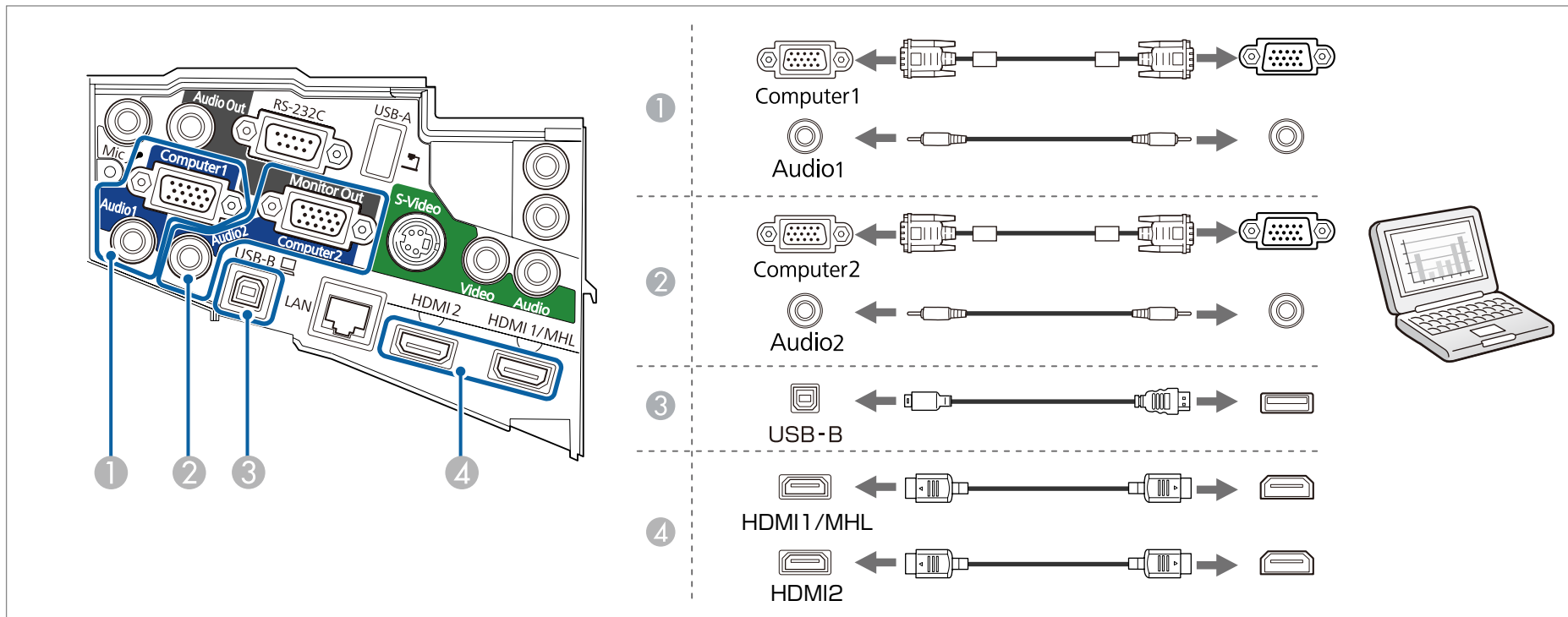

- When connecting to the Audio1, Audio2, and Computer1 ports, we recommend connecting cables to the ports in the following order: Audio1, Audio2, and then Computer1.
- You can also set the port used for audio input from the Configuration menu.
  - ☛ **Extended - A/V Settings - Audio Output** p.123
- If audio is not output when an HDMI cable is connected, connect a commercially available audio cable to the Audio Input port. After connecting the cable, select the input port you connected to from **HDMI1 Audio Output** or **HDMI2 Audio Output** from the Configuration menu.
  - ☛ **Extended - A/V Settings - HDMI1 Audio Output/HDMI2 Audio Output** p.123
- You can use a USB cable to connect the projector to a computer to project images from the computer. This function is called USB Display.
  - ☛ "Projecting with USB Display" p.47
- When projecting a computer connected to the Monitor Out/Computer2 port, set the **Monitor Out Port** to **Computer2** from the Configuration menu.
  - ☛ **Extended - Operation - Monitor Out Port** p.123

## Connecting a Smartphone or Tablet Device

You can connect smartphones and tablet devices. By using a commercially available MHL cable, you can connect the MHL port on your device to the HDMI1/MHL port on the projector. You can send the audio with the projected image.

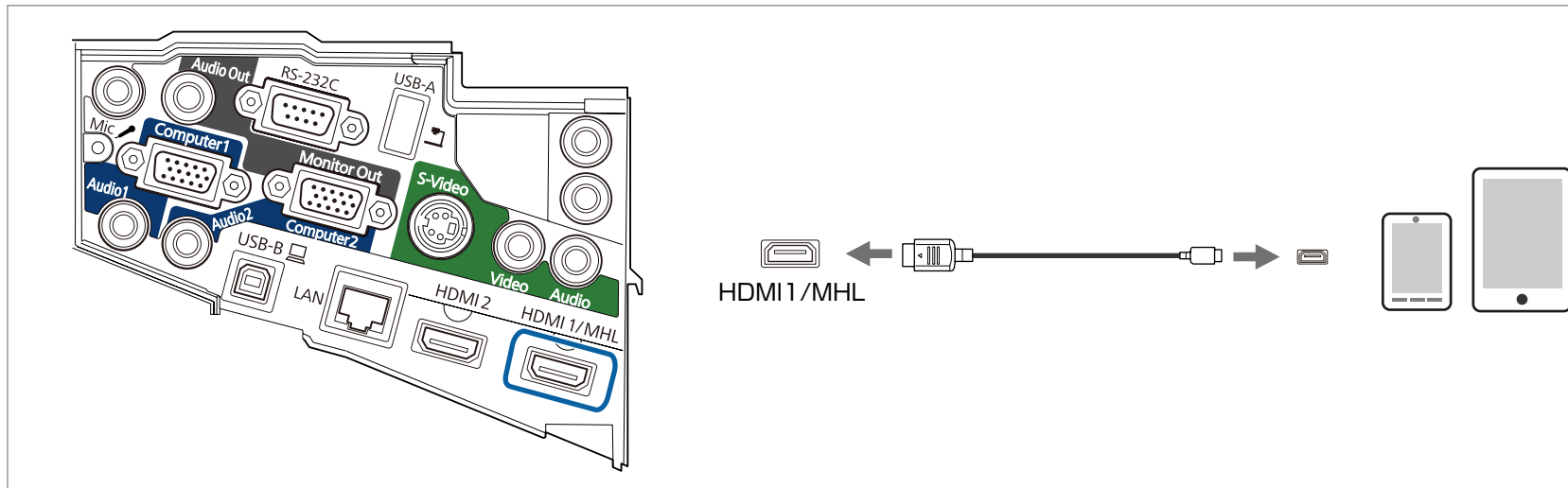

When you connect a smartphone or tablet device to the projector, the device starts charging when images are projected.

### Attention

- You may not be able to connect an MHL cable to all devices.
- Make sure the connection cable supports the MHL standards. If you connect a cable that does not support the MHL standards, the smartphone or tablet device may become hot, leak, or explode.
- If you connect using a commercially available MHL-HDMI conversion adapter, charging the smartphone or tablet device may not work or you may not be able to perform operations from the projector's remote control.



- If images are not projected correctly, disconnect and then reconnect the MHL cable.
- You may not be able to project correctly depending on the model and settings of the smartphone or tablet device.

## Connecting Image Sources

To project images from DVD players or VHS video and so on, connect to the projector using one of the following methods.

① **When using a commercially available video cable**

Connect the video output port on the image source to the projector's Video port using a commercially available video cable.

You can output audio from the projector's speaker by connecting the audio output port on the image source to the projector's Audio port using a commercially available audio cable.

② **When using a commercially available S-video cable**

Connect the video output port on the image source to the projector's S-Video port using a commercially available video cable.

You can output audio from the projector's speaker by connecting the audio output port on the image source to the projector's Audio port using a commercially available audio cable.

③ ④ **When using the optional component video cable**

☛ "Optional Accessories and Consumables" [p.174](#)

Connect the component output port on the image source to the projector's Computer1 or Computer2 port.

You can output audio from the projector's speaker by connecting the image source's audio output port to the projector's Audio1 or Audio2 port using a commercially available audio cable.

⑤ **When using a commercially available HDMI cable**

Connect the image source's HDMI port to the projector's HDMI1/MHL or HDMI2 port.

Audio from the image source is output from the projector with the projected image.

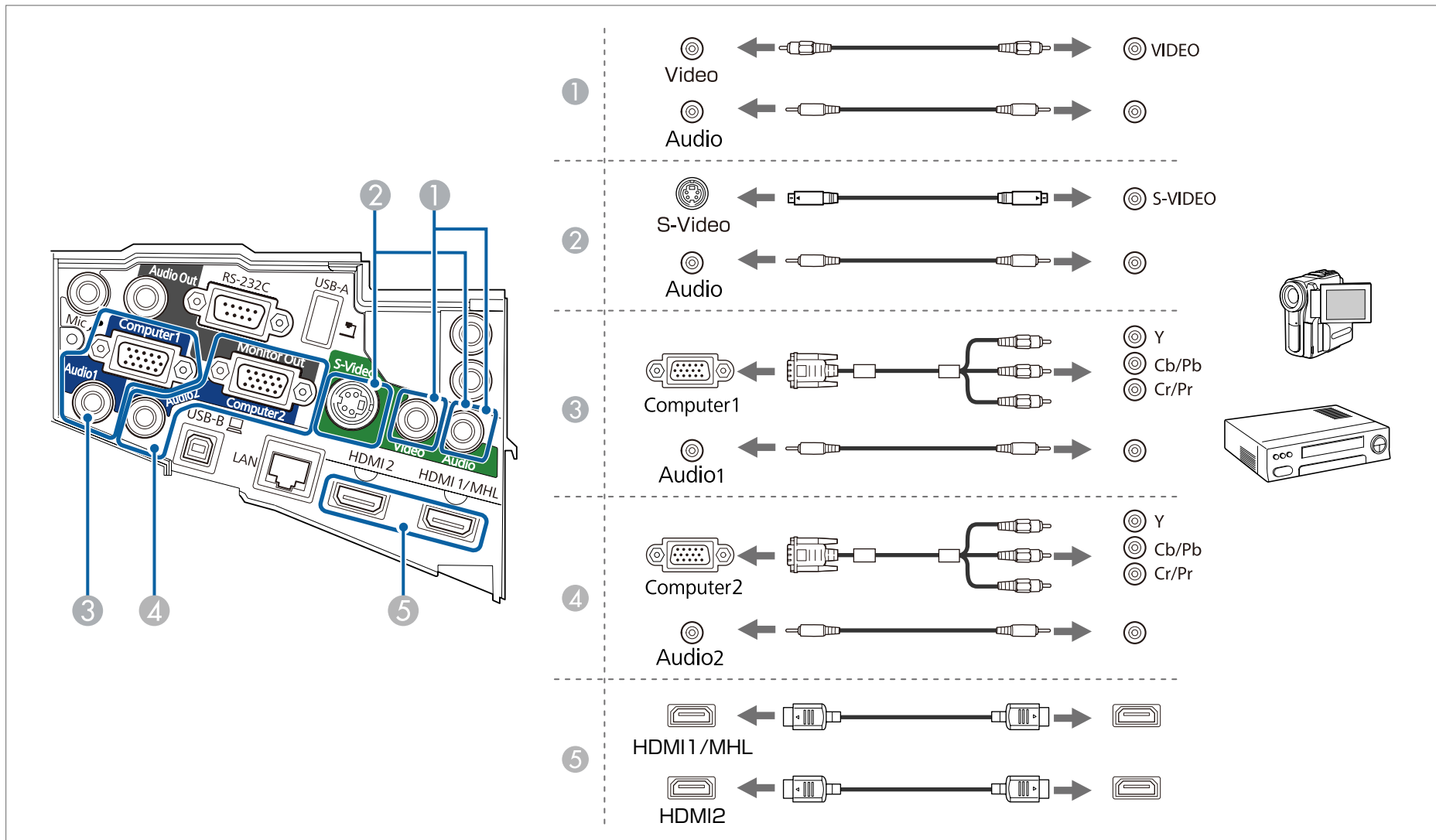

### Attention

- Turn off the equipment you want to connect before connecting. If the input source is on when you connect it to the projector, it could cause a malfunction.
- If the orientation or shape of the plug differs, do not try to force it in. The device could be damaged or could malfunction.





- You can also set the port used for audio input from the Configuration menu.
  - ☛ **Extended - A/V Settings - Audio Output** [p.123](#)
- When projecting an image source connected to the Monitor Out/Computer2 port, set the **Monitor Out Port** to **Computer2** from the Configuration menu.
  - ☛ **Extended - Operation - Monitor Out Port** [p.123](#)
- If audio is not output when an HDMI cable is connected, connect a commercially available audio cable to the Audio Input port. After connecting the cable, select the Audio Input port you connected to from **HDMI1 Audio Output** or **HDMI2 Audio Output** from the Configuration menu.
  - ☛ **Extended - A/V Settings - HDMI1 Audio Output/HDMI2 Audio Output** [p.123](#)
- If the source you want to connect to has an unusually shaped port, use the cable supplied with the device or an optional cable to connect to the projector.
- When using a commercially available 2RCA(L/R)/stereo mini-pin audio cable, make sure it is labeled "No resistance".

## Connecting USB Devices

You can connect devices such as USB memory, the optional Document Camera, and USB compatible hard disks and digital cameras. Using the USB cable supplied with the USB device, connect the USB device to the USB-A port on the projector.

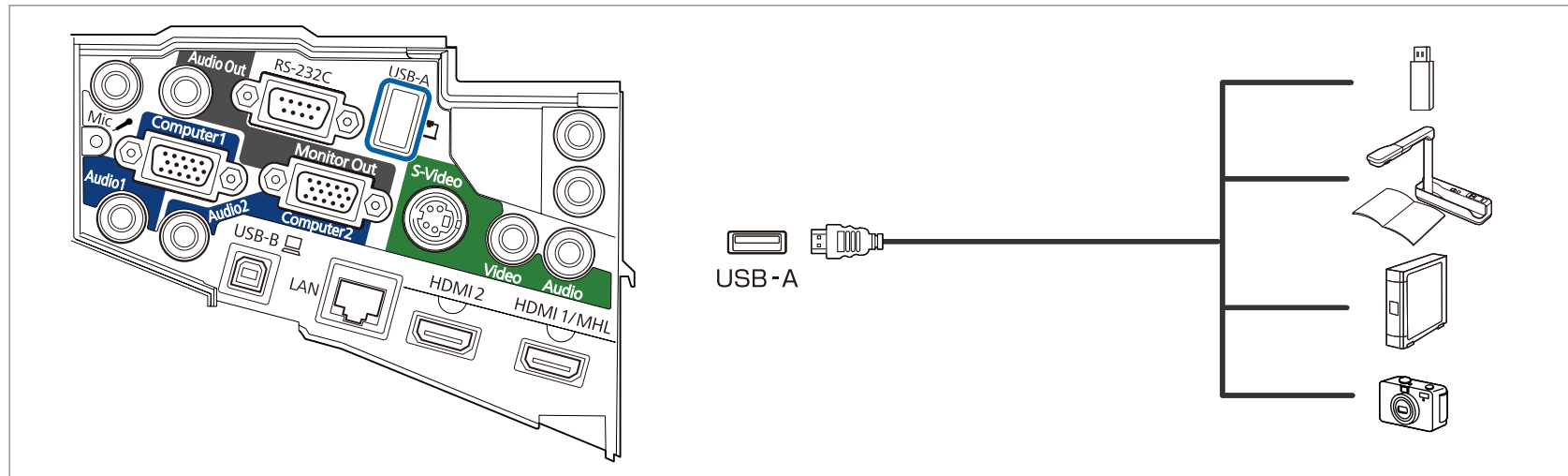

When the USB device is connected, you can project image files on the USB memory or digital camera using PC Free.

☛ "Projecting Images Stored on a USB Storage Device (PC Free)" [p.88](#)

If the Document Camera is connected while projecting images from another input port, press the [USB] button on the remote control, or the [Source Search] button on the control panel, to switch to images from the Document Camera.

☛ "Automatically Detect Input Signals and Change the Projected Image (Source Search)" [p.45](#)



While projecting images from a USB device, if you want to connect an audio output device, connect it to the Audio2 port.

### Attention

- If you use a USB hub, operation may not be performed correctly. Devices such as digital cameras and USB devices should be connected to the projector directly.
- When connecting and using a USB-compatible hard disk, make sure you connect the AC adaptor supplied with the hard disk.
- Connect a digital camera or hard disk to the projector using a USB cable supplied with or specified for use with the device.
- Use a USB cable less than 3 m in length. If the cable exceeds 3 m, PC Free may not function correctly.

### Removing USB Devices

After finishing projecting, remove USB devices from the projector. For devices such as digital cameras or hard disks, turn off the device and then remove it from the projector.

## Connecting a Microphone

You can output microphone audio from the projector's speaker by connecting a commercially available dynamic microphone.

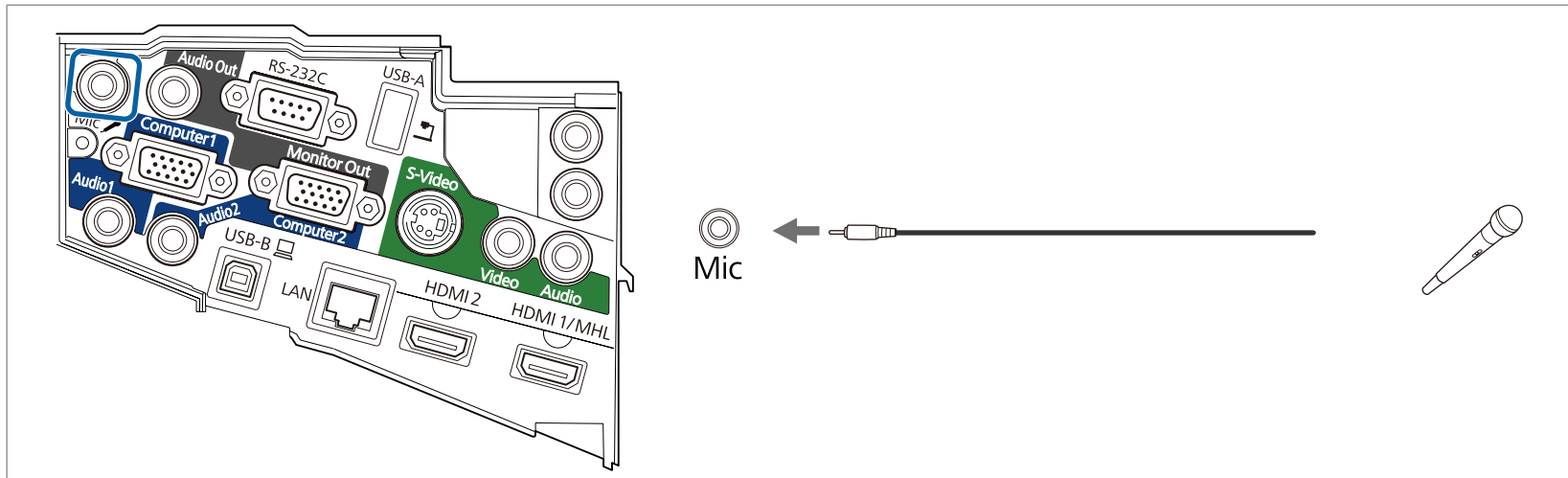

- Plug-in-power is not supported.
- Adjust **Mic Input Level** if the microphone audio is difficult to hear, or if it is too loud resulting in a crackling sound.
  - ☛ **Settings - Mic Input Level** [p.122](#)
- Make the following settings to output audio from a microphone when the projector is off.
  - Set **Standby Mode** to **Communication On**.
  - Set **A/V Output** to **Always On**.
  - ☛ **ECO - Standby Mode** [p.135](#)
  - ☛ **Extended - A/V Settings - A/V Output** [p.123](#)

## Connecting External Equipment

You can output images and audio by connecting an external monitor or speaker.

**1 When outputting images to an external monitor**

Connect the external monitor to the projector's Monitor Out port using the cable supplied with the external monitor.

**2 When outputting audio to an external speaker**

Connect the external speaker to the projector's Audio Out port using a commercially available audio cable.

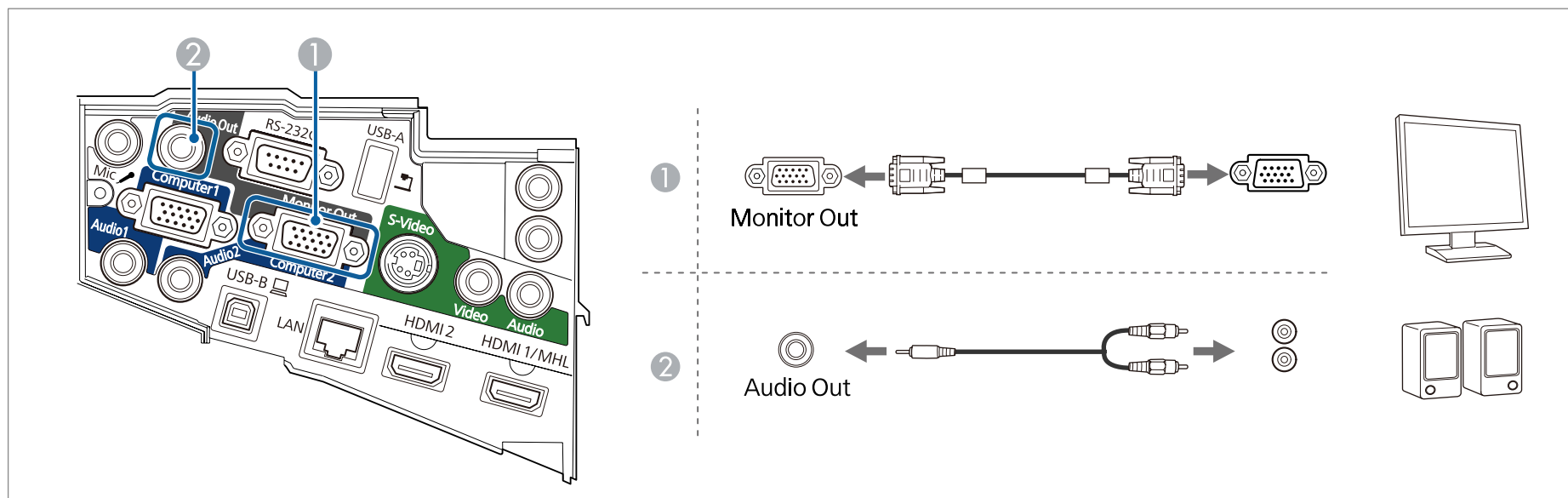



- When outputting images to an external monitor, set **Monitor Out Port** to **Monitor Out** from the Configuration menu.
  - ☛ **Extended - Operation - Monitor Out Port** [p.123](#)
- When **Standby Mode** is set to **Communication On**, you can perform the following operations even when the projector is off (only when **A/V Output** is set to **Always On**).
  - Output images to an external monitor
  - Output audio from an external speaker (audio being input from the USB-B and LAN ports cannot be output)
    - ☛ **ECO - Standby Mode** [p.135](#)
    - ☛ **Extended - A/V Settings - A/V Output** [p.123](#)
- Only analog RGB signals from the Computer1 port can be output to an external monitor. You cannot output signals input from other ports or component video signals.
- Setting gauges for functions such as Keystone, Configuration menu, or Help screens are not output to the external monitor.
- Content drawn using the interactive features is not displayed on an external monitor (EB-585Wi/EB-575Wi only). Content drawn using the supplied Easy Interactive Tools can be displayed on an external monitor.
- When the audio cable jack is inserted into the Audio Out port, audio stops being output from the projector's built-in speakers and switches to external output.

## Connecting a LAN Cable

Connect a LAN port on network hubs or other equipment to the projector's LAN port with a commercially available 100BASE-TX or 10BASE-T LAN cable.

By connecting a computer to the projector over a network, you can project images and check the status of the projector.

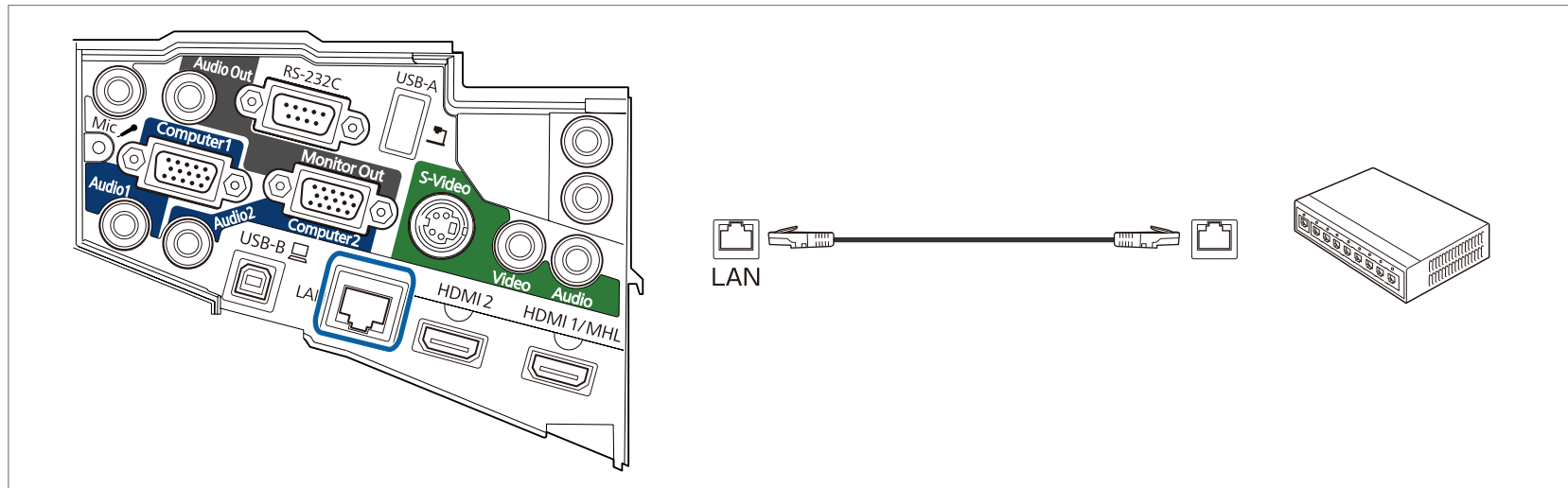

To prevent malfunctions, use a category 5 or higher shielded LAN cable.

## Installing the Optional Wireless LAN Unit

- 1** Remove both of the cable cover fixing screws to open the cable cover.

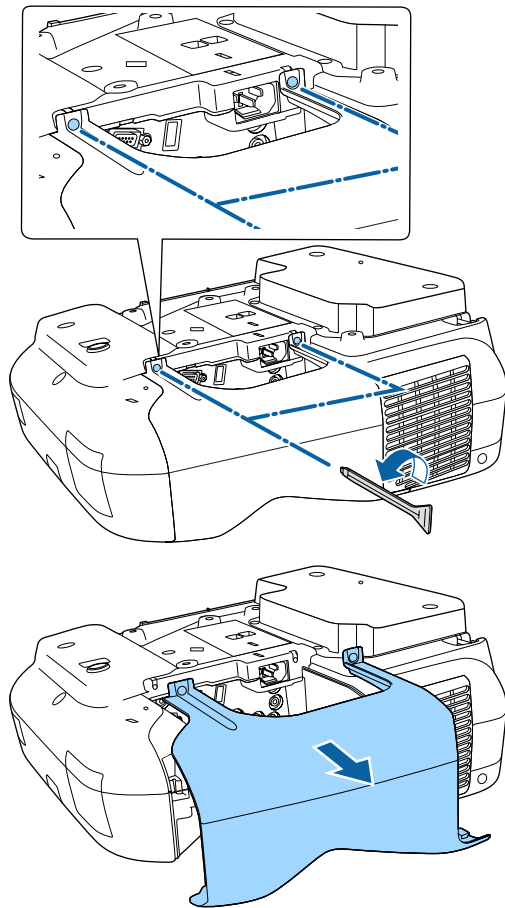

- 2** Connect the Wireless LAN unit to the wireless LAN unit installation section.

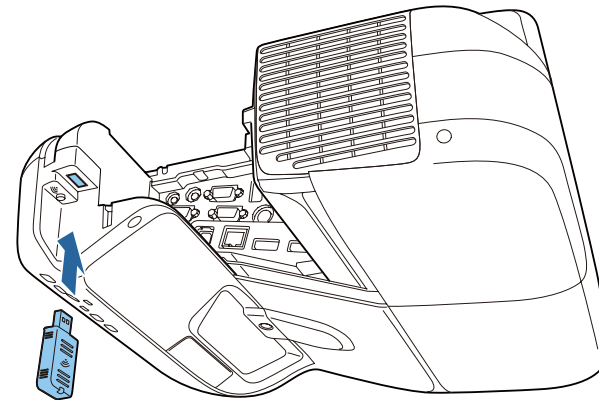



## Connecting Multiple Projectors (EB-585Wi/EB-575Wi only)

When using the interactive features in the same room as multiple versions of the same projector, you need to connect the optional remote control cable set (ELPKC28) to the SYNC port on each projector. Interactive pen operations are stabilized by linking the projectors using cables.

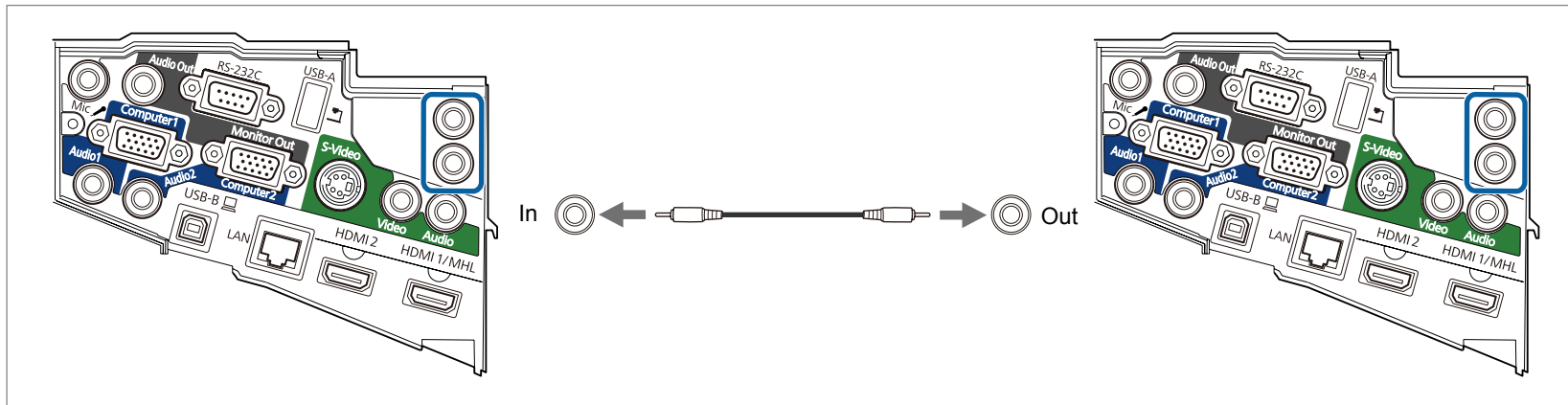

The SYNC port has an IN and OUT socket. When you connect one end of the remote control cable set to an IN socket, connect the other end to an OUT socket.

After connecting the cables, set **Sync of Projectors** to **Wired** from the Configuration menu.

☛ **Extended - Easy Interactive Function - Advanced - Sync of Projectors** [p.126](#)



- When connecting three or more projectors, you do not need to connect the first projector to the last projector.

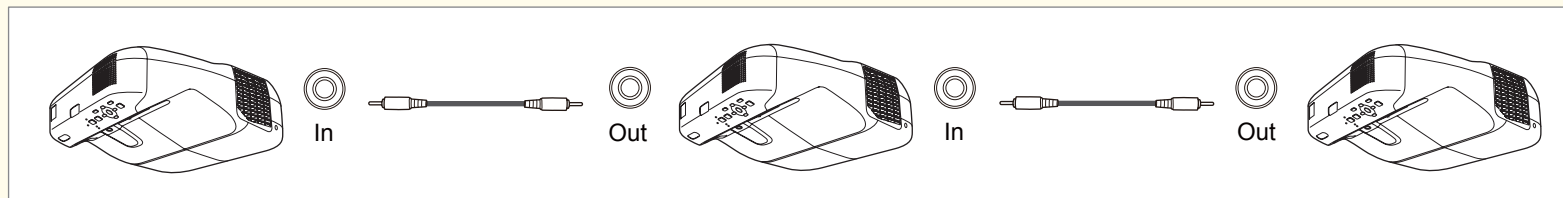

- When using the projector in the same room as another projector that does not support cable connection, set **Wired Sync Mode** to **Mode 2** from the Configuration menu.
  - ☛ **Extended - Easy Interactive Function - Advanced - Wired Sync Mode** [p.126](#)
- If you do not have the optional remote control cable set, change the **Distance of Projectors** setting from the Configuration menu.
  - ☛ **Extended - Easy Interactive Function - Advanced - Distance of Projectors** [p.126](#)



## Basic Usage

This chapter explains how to project and adjust images.

## Getting Ready to Project

This section explains the procedure for connecting the projector to a computer with the computer cable and projecting images.

### Caution

Be sure to connect the cable of the source to the projector first, and then connect the power cord to the projector.

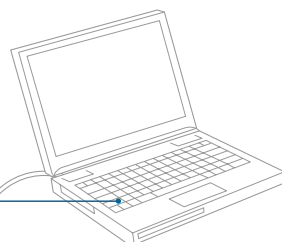
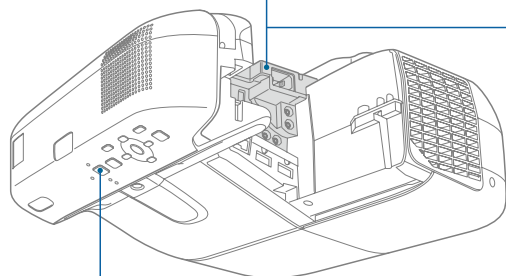
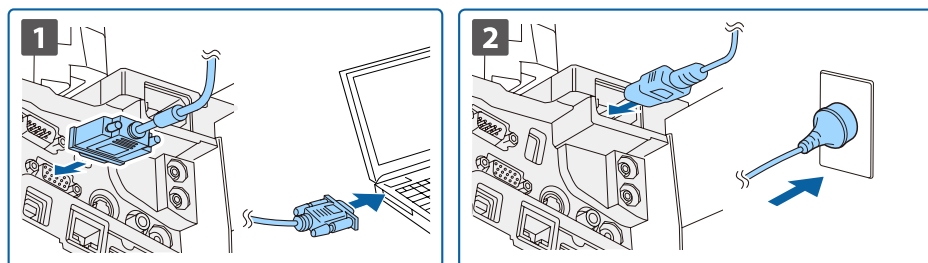

**1** Connect the projector to the computer with the computer cable.

**2** Connect the projector to an electrical outlet with the power cord.

**3** Turn on the projector.

### Warning

When turning on the projector, do not remove the projection lens. This could cause damage to eyesight due to the powerful light emitted. When turning on the projector at a distance using the remote control, make sure there is no one looking into the lens.

Take particular care when there are children present.

**4** Turn on the computer.

**5** Change the computer's screen output.

When using a laptop computer, you need to change the screen output from the computer.

Hold down the Fn key (function key), and press the  key.



- The method for changing differs depending on the computer being used. See the documentation supplied with the computer.
- Press the  power button twice to turn the projector off.

If the image is not projected, you can change the projected image using one of the following methods.

- Press the [Source Search] button on the control panel or the remote control.
  - "Automatically Detect Input Signals and Change the Projected Image (Source Search)" [p.45](#)
- Press the button for the target port on the remote control.
  - "Switching to the Target Image Using the Remote Control" [p.46](#)



After projecting the image, adjust the image if necessary.

- ☛ "Correcting Keystone Distortion" [p.50](#)
- ☛ "Correcting the Focus" [p.55](#)

## Automatically Detect Input Signals and Change the Projected Image (Source Search)

Press the [Source Search] button to project images from the port currently receiving an image.

### Using Remote Control

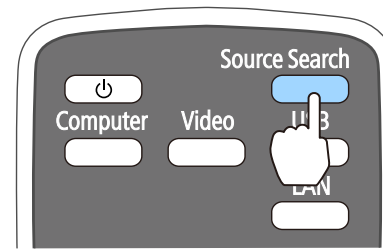

### Using the Control Panel

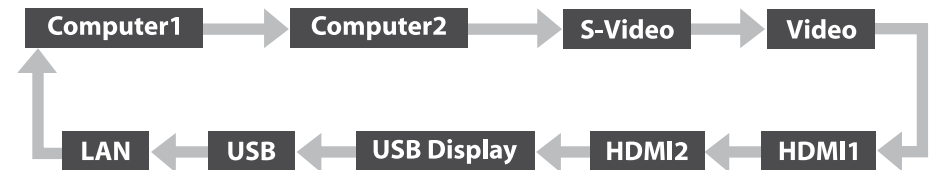
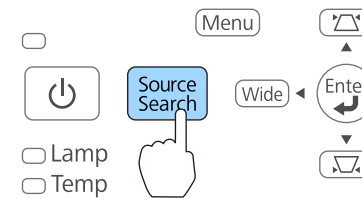

When two or more image sources are connected, press the [Source Search] button until the target image is projected.

When your video equipment is connected, start playback before beginning this operation.



- You can make settings so that images are projected from the same input port the next time the projector is turned on.
  - Extended - Operation - Startup Source Search p.123
- The following screen is displayed while no image signals are input.

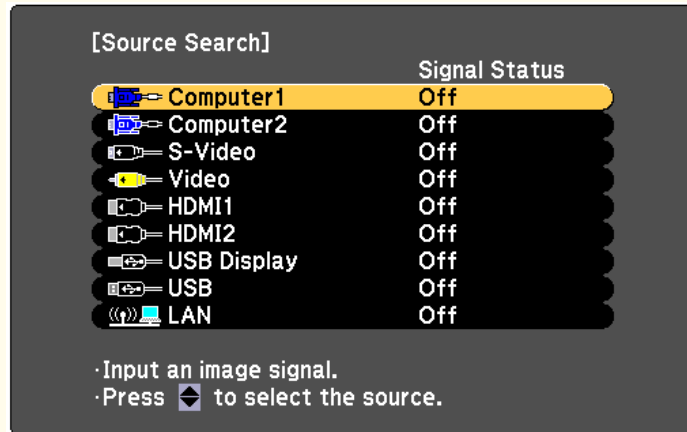

## Switching to the Target Image Using the Remote Control

You can change directly to the target image by pressing the following buttons on the remote control.

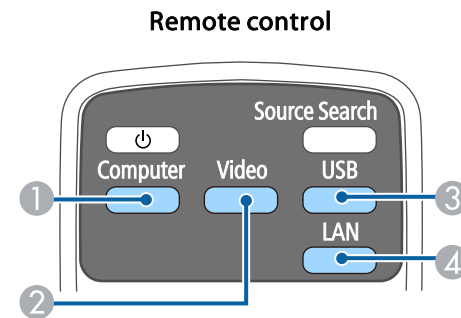

- Each time the button is pressed, it cycles through the images being input from the following sources.
  - Computer1 port
  - Computer2 port
- Each time the button is pressed, it cycles through the images being input from the following sources.
  - S-Video port
  - Video port
  - HDMI1/MHL port
  - HDMI2 port
- Each time the button is pressed, it cycles through the images being input from the following sources.
  - USB Display
  - Images from the device connected to the USB-A port
- Switches to the image from the network connected device.

## Projecting with USB Display

You can use the supplied or a commercially available USB cable to connect the projector to a computer to project images from the computer.

You can send the computer's audio with the projected image.

Set **USB Type B** to **USB Display/Easy Interactive Function** or **Wireless Mouse/USB Display** to use USB Display on EB-585Wi/EB-575Wi.

☛ **Extended - USB Type B** [p.123](#)

## System Requirements

### For Windows

OS	Windows 2000*1	
	Windows XP	Professional 32 bit Home Edition 32 bit Tablet PC Edition 32 bit
	Windows Vista	Ultimate 32 bit Enterprise 32 bit Business 32 bit Home Premium 32 bit Home Basic 32 bit
	Windows 7	Ultimate 32- and 64-bit Enterprise 32- and 64-bit Professional 32- and 64-bit Home Premium 32- and 64-bit Home Basic 32 bit Starter 32 bit
	Windows 8	Windows 8 32- and 64-bit Windows 8 Pro 32- and 64-bit Windows 8 Enterprise 32- and 64-bit

	Windows 8.1	Windows 8.1 32- and 64-bit Windows 8.1 Pro 32- and 64-bit Windows 8.1 Enterprise 32- and 64-bit
<b>CPU</b>	Mobile Pentium III 1.2 GHz or faster Recommended: Pentium M 1.6 GHz or faster	
<b>Amount of Memory</b>	256 MB or more Recommended: 512 MB or more	
<b>Hard Disk Space</b>	20 MB or more	
<b>Display</b>	Resolution of no less than 640x480 and no higher than 1600x1200. Display color of 16-bit color or greater	

\*1 Service Pack 4 only

### For OS X

<b>OS</b>	Mac OS X 10.5.x 32 bit Mac OS X 10.6.x 32- and 64-bit OS X 10.7.x 32- and 64-bit OS X 10.8.x OS X 10.9.x
<b>CPU</b>	Power PC G4 1GHz or faster Recommended: Core Duo 1.83GHz or faster
<b>Amount of Memory</b>	512 MB or more
<b>Hard Disk Space</b>	20 MB or more
<b>Display</b>	Resolution of no less than 640x480 and no higher than 1680x1200. Display color of 16-bit color or greater

## Connecting for the First Time

The first time you connect the projector and the computer using the USB cable, the driver needs to be installed. The procedure is different for Windows and OS X.



- You do not need to install the driver the next time you connect.
- When inputting images from multiple sources, change the input source to USB Display.
- If you are using a USB hub, operations may not be performed correctly. Connect the USB cable directly to the projector.
- You cannot change option settings while using USB Display.

### For Windows

- 1 Connect the computer's USB port to the projector's USB-B port using the supplied or a commercially available USB cable.



For Windows 2000 or Windows XP, a message asking you if you want to restart your computer may be displayed. Select **No**.

### For Windows 2000

Double-click **Computer - EPSON PJ\_UD - EMP\_UDSE.EXE**.

### For Windows XP

Driver installation starts automatically.

### For Windows Vista/Windows 7/Windows 8/Windows 8.1

When the dialog box is displayed, click run **EMP\_UDSE.EXE**.

- 2 When the License Agreement screen is displayed, click **Agree**.

- 3 Computer images are projected.

It may take a while for computer images to be projected. Until the computer images are projected, leave the equipment as is and do not disconnect the USB cable or turn off the power of the projector.

- 4 Disconnect the USB cable when you are finished.

When disconnecting the USB cable, there is no need to use **Safely Remove Hardware**.



- If it is not installed automatically, double-click **My Computer - EPSON PJ\_UD - EMP\_UDSE.EXE** on your computer.
- If nothing is projected, click **All Programs - EPSON Projector - Epson USB Display - Epson USB Display Ver.x.xx** on your computer.
- When using a computer running Windows 2000 under user authority, a Windows error message is displayed and you may not be able to use the software. In this case, try updating Windows to the latest version, restart, and then try to connect again.  
For more details, contact your local dealer or the nearest address provided in the following document.  
[Epson Projector Contact List](#)

### For OS X

- 1 Connect the computer's USB port to the projector's USB-B port using the supplied or a commercially available USB cable. The Setup folder of USB Display is displayed in the Finder.
- 2 Double-click the **USB Display Installer** icon.
- 3 Follow the on-screen instructions to install.



- 4** When the License Agreement screen is displayed, click **Agree**.  
Enter the administrator authority password and start the installation.  
When the installation is complete, the USB Display icon is displayed in the Dock and menu bar.
- 5** Computer images are projected.  
It may take a while for computer images to be projected. Until the computer images are projected, leave the equipment as is and do not disconnect the USB cable or turn off the power of the projector.
- 6** When you have finished, select **Disconnect** from the menu bar or from the **USB Display** icon on the Dock. You can then disconnect the USB cable.



- If the USB Display Setup folder is not displayed automatically in the Finder, double-click **EPSON PJ\_UD - USB Display Installer** on your computer.
- If nothing is projected for some reason, click the **USB Display** icon in the Dock.
- If there is no **USB Display** icon on the Dock, double-click **USB Display** in the application folder.
- If you select **Exit** from the **USB Display** icon on the Dock, USB Display does not start automatically when you connect the USB cable.

## Uninstalling

### For Windows 2000

- 1** Click **Start**, select **Settings**, and then click **Control Panel**.
- 2** Double-click **Add/Remove Programs**.
- 3** Click **Change or Remove Programs**.
- 4** Select **Epson USB Display** and click **Change/Remove**.

### For Windows XP

- 1** Click **Start**, and then click **Control Panel**.
- 2** Double-click **Add or Remove Programs**.
- 3** Select **Epson USB Display**, and then click **Remove**.

### For Windows Vista/Windows 7

- 1** Click **Start**, and then click **Control Panel**.
- 2** Click **Uninstall a program** under **Programs**.
- 3** Select **Epson USB Display**, and then click **Uninstall**.

### For Windows 8/Windows 8.1

- 1** Open Charms, and then select **Search**. Right-click (hold down) **Epson USB Display Ver.x.xx**.
- 2** Select **Uninstall** from the app bar.
- 3** Select **Epson USB Display**, and then click **Uninstall**.
- 4** Follow the on-screen instructions to uninstall.

### For OS X

- 1** Double-click **Applications - USB Display - Tool**.
- 2** Run **USB Display Uninstaller**.

## Correcting Keystone Distortion

You can correct keystone distortion using one of the following methods.

- **H/V-Keystone**  
Manually correct distortion in the horizontal and vertical directions independently.

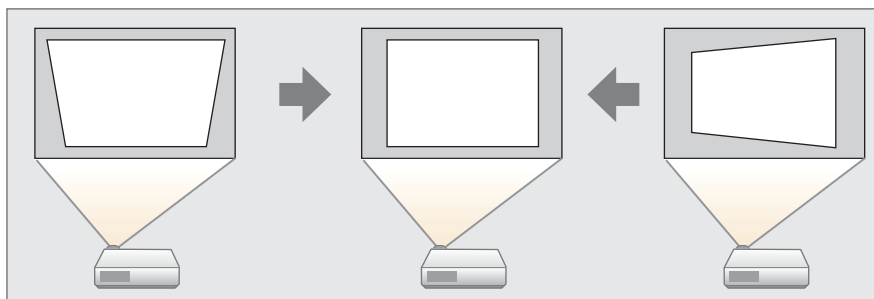

- **Quick Corner**  
Manually correct the four corners independently.

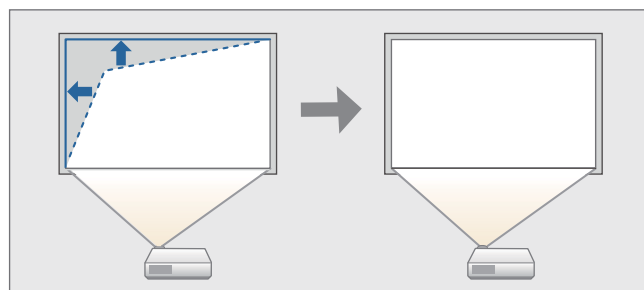

## H/V-Keystone

Manually correct distortion in the horizontal and vertical directions independently. H/V-Keystone correction is ideal for fine-tuning keystone distortion.

You can use H/V-Keystone to correct the projected image under the following conditions.

Correction angle: Approx. 3° right and left/Approx. 3° up and down

- 1 Press the [ $\nabla$ ] or [ $\nabla$ ] buttons on the control panel during projection to display the Keystone screen.

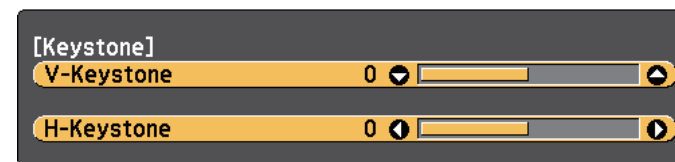

When you press the [ $\nabla$ ][ $\nabla$ ] buttons on the control panel, the correction method screen set in the Configuration menu is displayed. When you want to perform horizontal and vertical keystone correction using the [ $\nabla$ ][ $\nabla$ ] buttons, set **Keystone** to **H/V-Keystone** from the Configuration menu.

☛ [Settings - Keystone p.122](#)

- 2** Press the following buttons to correct keystone distortion. Press the [↕] or [↔] buttons to correct vertical distortion.

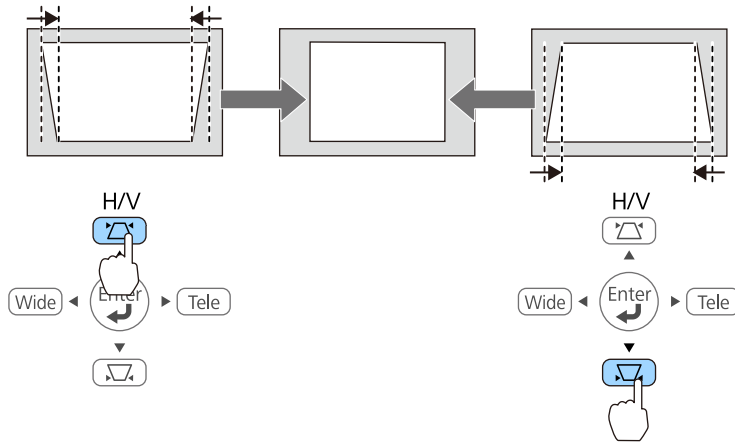

Press the [Wide] or [Tele] buttons to correct horizontal distortion.

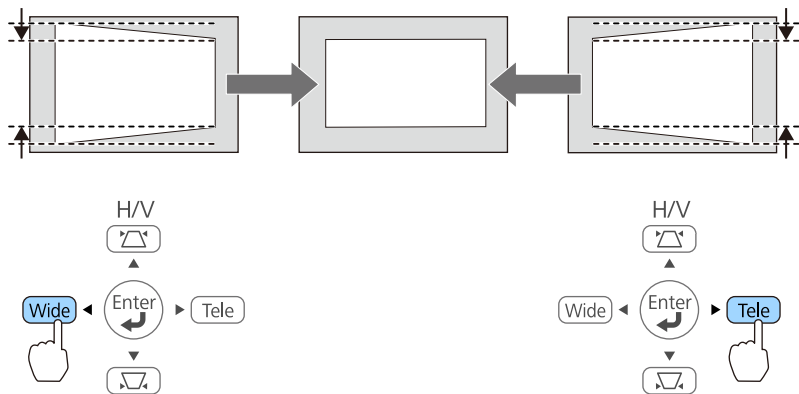

You can set H/V-Keystone from the Configuration menu.

☛ Settings - Keystone - H/V-Keystone [p.122](#)

## Quick Corner

This allows you to manually correct each of the four corners of the projected image separately.

- 1** Press the [Menu] button while projecting.

☛ "Using the Configuration Menu" [p.116](#)

### Using Remote Control

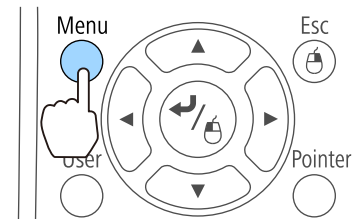

### Using the Control Panel

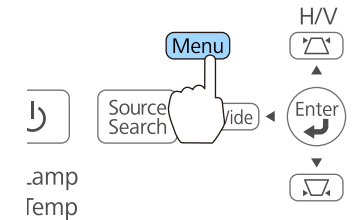

- 2** Select **Keystone** from **Settings**.

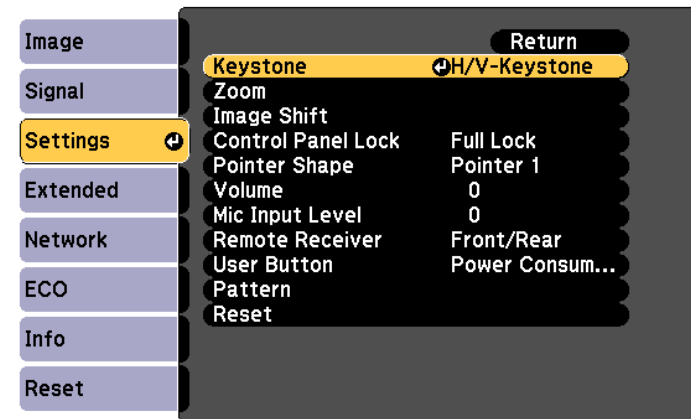

- 3** Select **Quick Corner**, and then press the [Enter] button.  
When the message "If this setting is changed, the image may be distorted." is displayed, press the [Enter] button again.

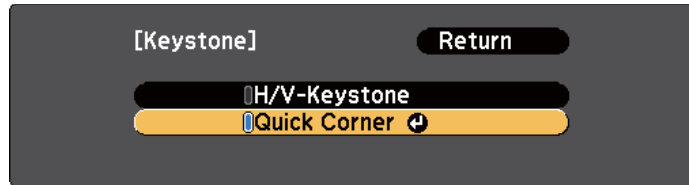

- 4** Select the corner to correct using the [▲], [▼], [◀], and [▶] buttons on the remote control, or the [△], [▽], [Wide], and [Tele] buttons on the control panel, and then press the [Enter] button.

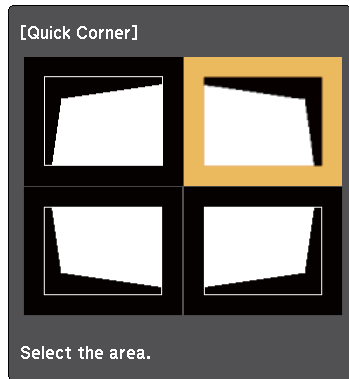

- 5** Correct the position of the corner using the [▲], [▼], [◀], and [▶] buttons on the remote control, or the [△], [▽], [Wide], and [Tele] buttons on the control panel.  
When you press the [Enter] button, the screen shown in step 4 is displayed.

If the message "Cannot adjust any further." is displayed while adjusting, you cannot adjust the shape any further in the direction indicated by the gray triangle.

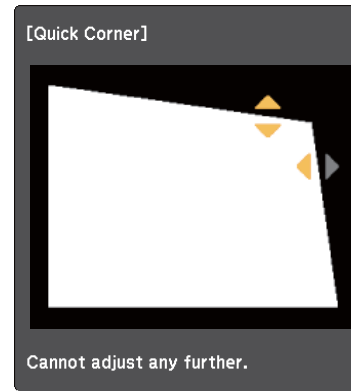

- 6** Repeat procedures 4 and 5 as needed to adjust any remaining corners.  
**7** Press the [Menu] button to finish making corrections.

- If the [Esc] button is held down for about two seconds while the corner selection screen from step 4 is displayed, the following screen is displayed.

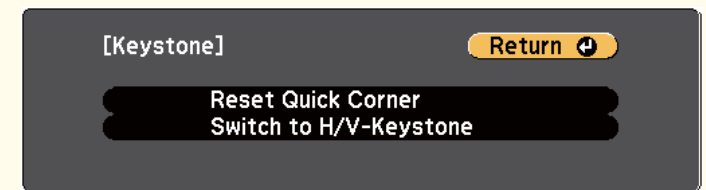

**Reset Quick Corner:** Resets the result of Quick Corner corrections.  
**Switch to H/V-Keystone:** Switches the correction method to H/V-Keystone.  
☛ "Settings Menu" [p.122](#)

## Adjusting the Image Size

Press the [Wide] and [Tele] buttons on the control panel to adjust the size of the projected image.

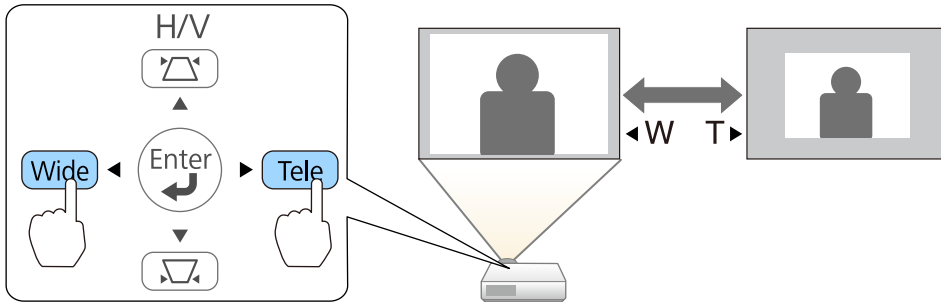

You can also make adjustments from the Configuration menu.  
 ➤ **Settings - Zoom** [p.122](#)

## Adjusting the Position of the Image (Image Shift)

You can fine tune the position of the image without moving the projector.

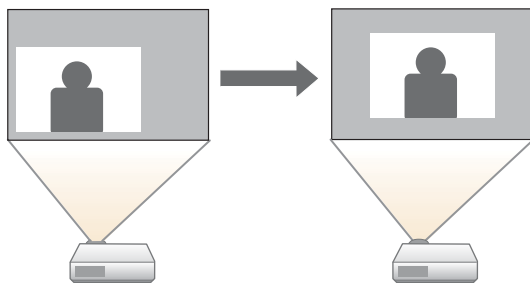

**1** Perform Adjust Zoom or Keystone.

➤ "Adjusting the Image Size" [p.53](#)

➤ "Correcting Keystone Distortion" [p.50](#)

The Image Shift screen is displayed after you have made adjustments.

**2** Adjust the projection position using the [▲], [▼], [◀], and [▶] buttons on the remote control, or the [↖], [↘], [Wide], and [Tele] buttons on the control panel.

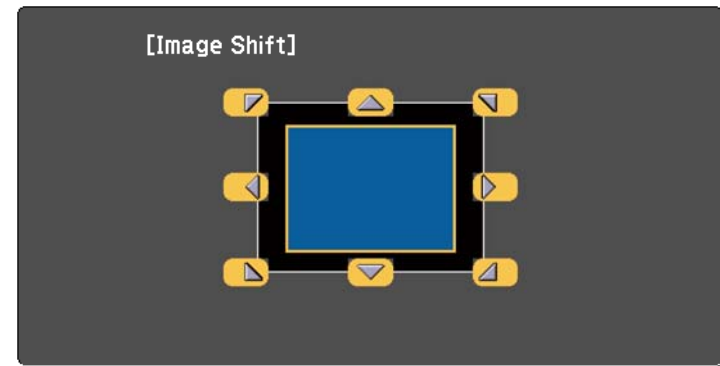

### Using Remote Control

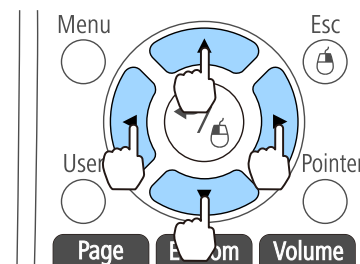

### Using the control panel

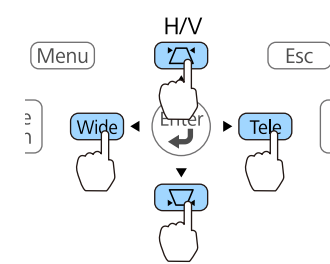

You can shift the image diagonally by pressing any pair of adjacent [▲], [▼], [◀], and [▶] buttons, or a combination of [↖], [↘], [Wide], and [Tele] buttons on the remote control or control panel.

- 3** Press the [Esc] button to close the adjustment screen.  
The adjustment screen disappears if no operation is performed after approximately 10 seconds.



- You cannot adjust the image position when Zoom is set to the maximum **Wide** position.
- The Image Shift setting is retained even if the projector is turned off. You need to re-adjust the position if you change the installation location or angle of the projector.
- You can also use the Configuration menu to adjust the position of the image.

☛ **Settings - Image Shift** p.122

## Adjusting the Vertical Position of the Image (Models Supplied with the Feet only)

Extend the feet. You can adjust the vertical position of the image by tilting the projector up to 1.5°.



The larger the angle of tilt, the harder it becomes to focus. Install the projector so that it only needs to be tilted at a small angle.

## Raising the Height of the Image

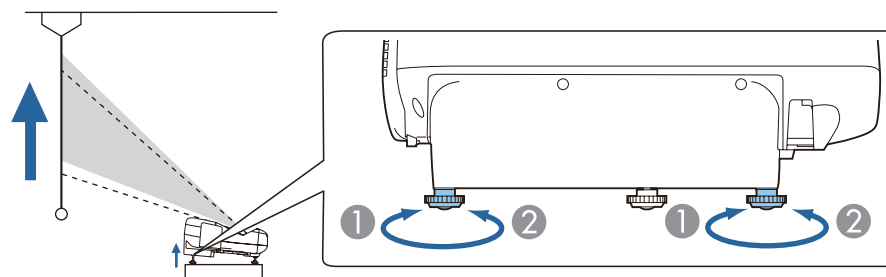

- ① You can raise the height of the image by extending the rear feet.
- ② Retract the rear feet to return the image to its original height.

## Lowering the Height of the Image

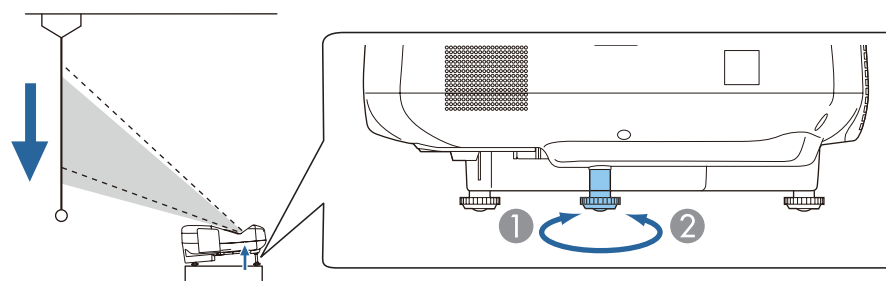

- ① You can lower the height of the image by extending the front foot.
- ② Retract the front foot to return the image to its original height.

## Adjusting the Horizontal Position of the Image (Models Supplied with the Feet only)

Extend and retract the rear feet to adjust the projector's horizontal tilt.

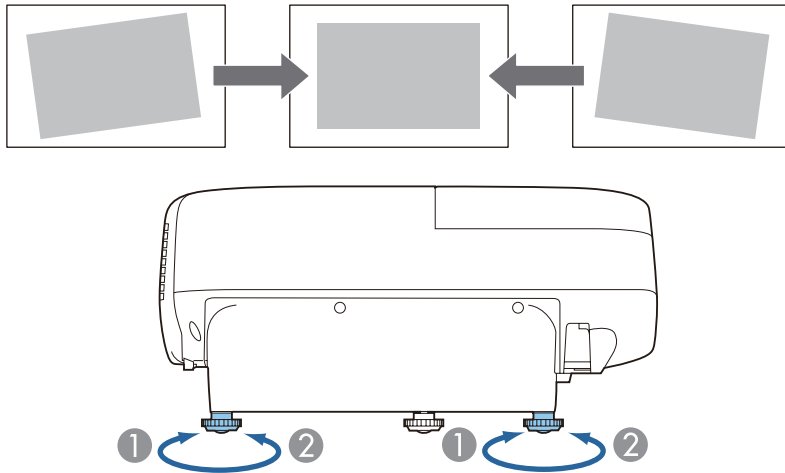

- ① Extend the rear foot.
- ② Retract the rear foot.

## Correcting the Focus

Display the test pattern, and then adjust the focus.

- 1 Press the [Menu] button.

➔ "Using the Configuration Menu" p.116

### Using Remote Control

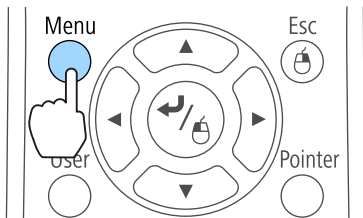

### Using the Control Panel

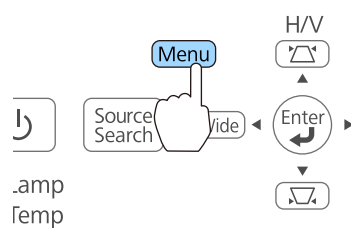

- 2 Select **Pattern** from **Settings**.

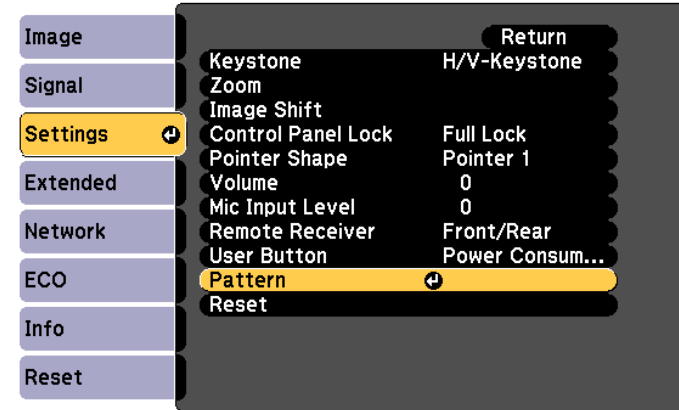

- 3 Select **Test Pattern**, and then press the [Enter] button.

When projecting images on a 4:3 screen using a wide-screen projector, select **Pattern 5** from **Pattern Type**.

➔ Settings - Pattern - Pattern Type p.122

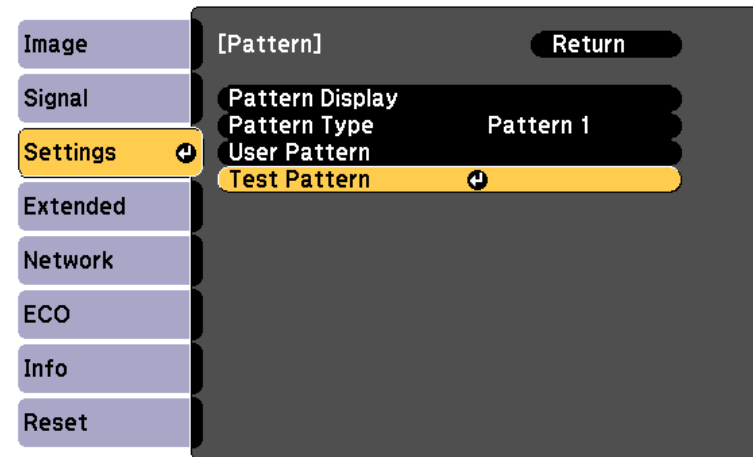

**4** Open the air filter cover.

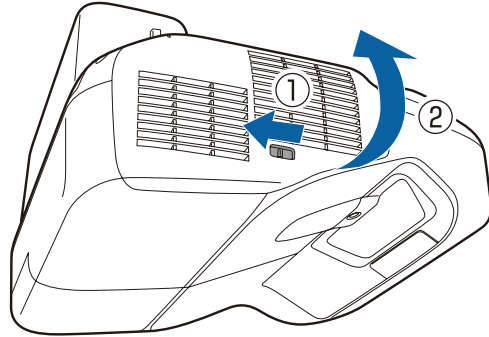

**5** Focus to the center-bottom (  ) of the projected screen. Move the focus lever to adjust the focus.

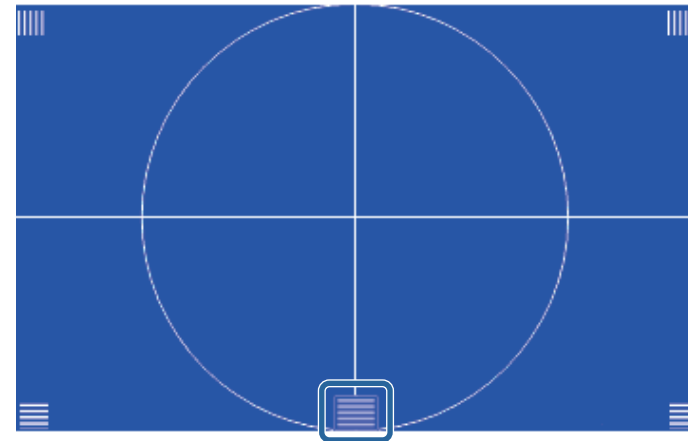
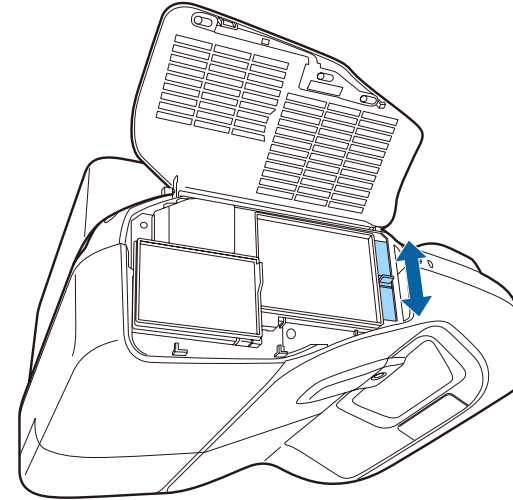



- 6** Check that the focus matches the corners (  ) of the projected screen.

If any areas are out of focus, use the focus lever to adjust until the corners are the same focus.

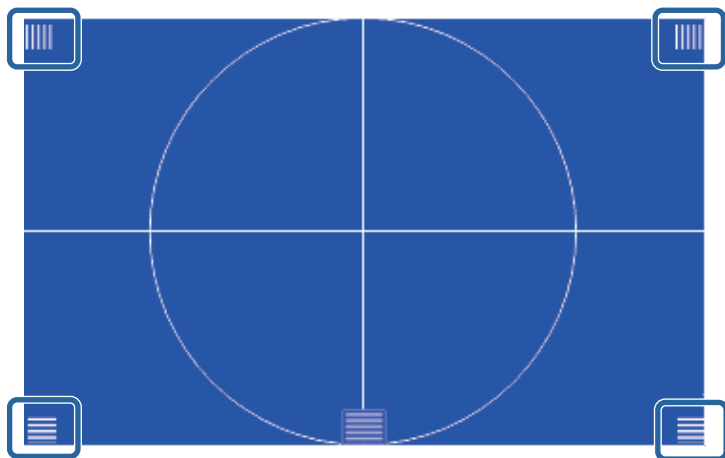
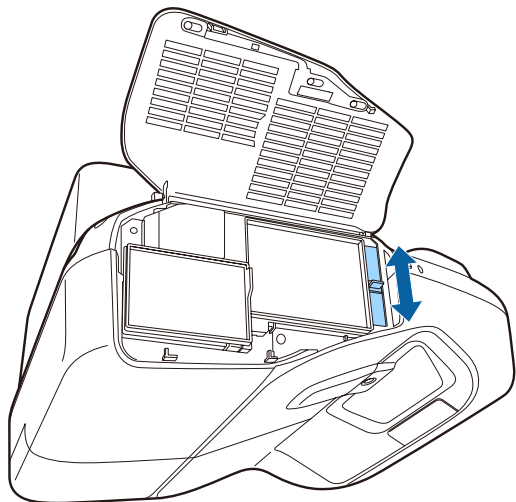

- 7** To remove the Test Pattern, press the [Esc] button on the remote control or the control panel.

## Adjusting the Volume

You can adjust the volume using one of the following methods.

- Press the [Volume] buttons on the remote control to adjust the volume.
  - [<img alt="volume down icon" data-bbox="535 335 555 355"/>>] Decreases the volume.
  - [<img alt="volume up icon" data-bbox="535 358 555 378"/>>] Increases the volume.

### Remote control

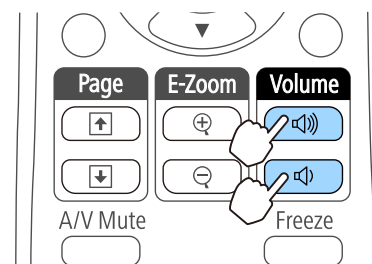

- Adjust the volume from the Configuration menu.
  - ☛ **Settings - Volume** [p.122](#)

### **Caution**

Do not start when the volume is set too high. A sudden increase in volume may cause loss of hearing. Always lower the volume before powering off, so that you can power on and then gradually increase the volume.

## Selecting the Projection Quality (Selecting Color Mode)

You can easily obtain the optimum image quality simply by selecting the setting that best corresponds to your surroundings when projecting. The brightness of the image varies depending on the mode selected.

Mode	Application
<b>Dynamic</b>	Ideal for use in a bright room. This is the brightest mode.
<b>Presentation</b>	Ideal for making presentations using color materials in a bright room.
<b>Theatre</b>	Ideal for watching films in a dark room. Gives images a natural tone.
<b>Photo*1</b>	Ideal for projecting still pictures, such as photos, in a bright room. The images are vivid and brought into contrast.
<b>Sports*2</b>	Ideal for watching TV programmes in a bright room. The images are vivid and brought to life.
<b>sRGB</b>	Ideal for images that conform to the <u>sRGB</u> color standard.
<b>Blackboard</b>	Even if you are projecting onto a blackboard (greenboard), this setting gives your images a natural tint, just like when projecting onto a screen.
<b>Whiteboard</b>	Ideal for making presentations using a whiteboard.

\*1 This selection is only available when the input signal is RGB or when the source is USB Display, USB, or LAN.

\*2 This selection is only available when the input signal is component video, or when the input source is Video or S-Video.

Each time you press the [Color Mode] button, the Color Mode name is displayed on the screen and the Color Mode changes.

### Remote control

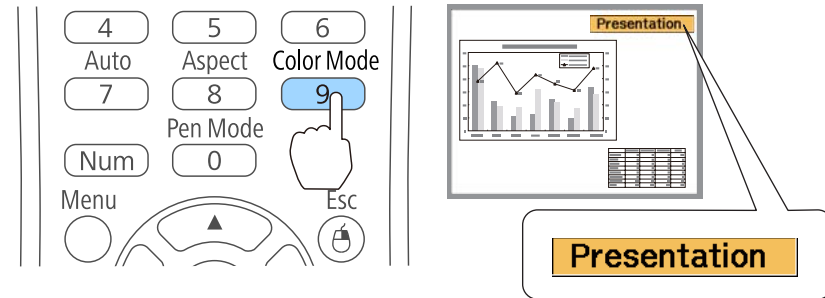

You can set Color Mode from the Configuration menu.  
**Image - Color Mode** [p.119](#)

## Setting Auto Iris

By automatically setting the luminance according to the brightness of the displayed image, it lets you enjoy deep and rich images.

- 1** Press the [Menu] button.  
 "Using the Configuration Menu" [p.116](#)

### Using Remote Control

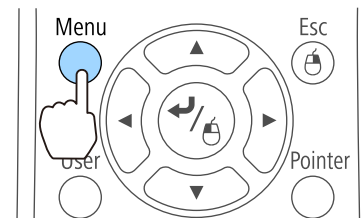

### Using the Control Panel

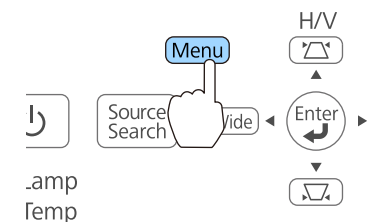

**2** Select **Auto Iris** from **Image**.

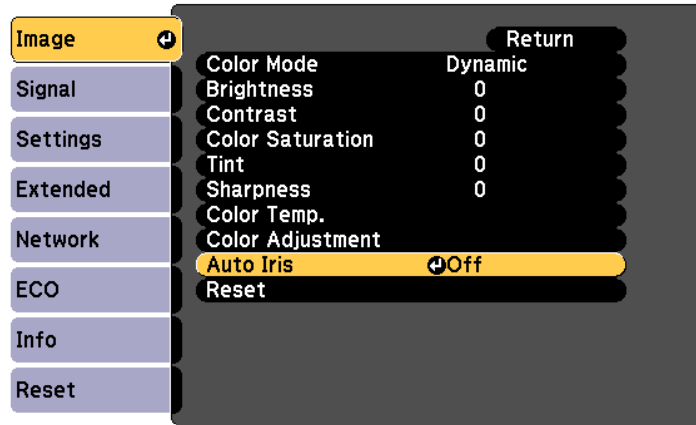

**3** Select **Normal** or **High Speed**.  
The setting is stored for each Color Mode.

**4** Press the [Menu] button to finish making settings.

**Auto Iris** can only be set when the **Color Mode** is set to **Dynamic** or **Theatre**.

## Changing the Aspect Ratio of the Projected Image

You can change the Aspect Ratio of the projected image to suit the type, the ratio of height and width, and the resolution of the input signals.

Available Aspect Modes vary depending on the image signal currently being projected.

## Changing Methods

Each time you press the [Aspect] button on the remote control, the aspect mode name is displayed on the screen and the aspect ratio changes.

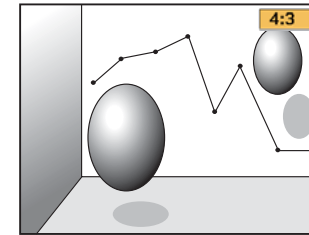
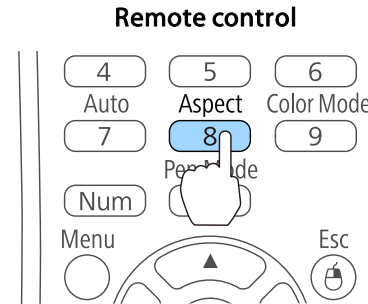

You can set the aspect ratio from the Configuration menu.  
**Signal - Aspect** p.120

## Changing the Aspect Mode (EB-585Wi/EB-585W/EB-575Wi/EB-575W only)

Projecting Images from Video Equipment or from the HDMI/MHL Port

Each time the [Aspect] button on the remote control is pressed, the aspect mode changes in the order **Normal** or **Auto**, **16:9**, **Full**, **Zoom**, and **Native**.

Example: 1080p signal input (resolution: 1920x1080, aspect ratio: 16:9)

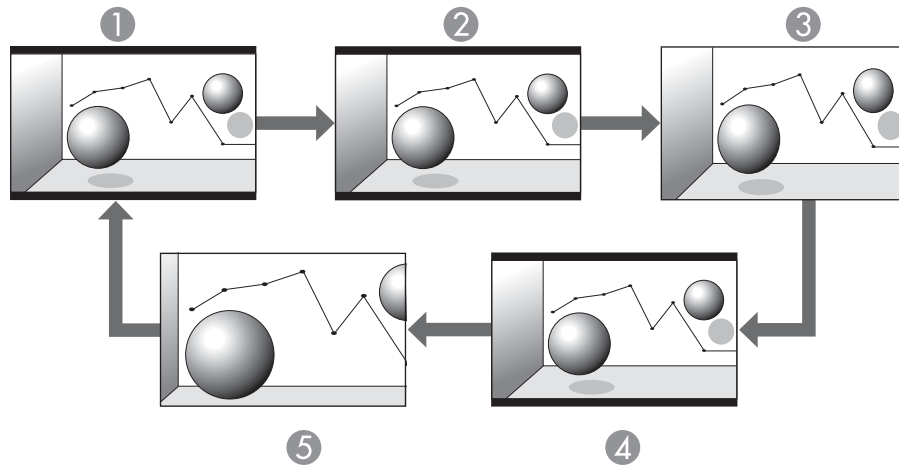

- ① Normal or Auto
- ② 16:9
- ③ Full
- ④ Zoom
- ⑤ Native

## Projecting Images from a Computer

The following shows projection examples for each aspect mode.

Aspect mode	Input Signal	
	XGA 1024X768(4:3)	WXGA 1280X800(16:10)
Normal		

Aspect mode	Input Signal	
	XGA 1024X768(4:3)	WXGA 1280X800(16:10)
16:9		
Full		
Zoom		
Native		



If parts of the image are missing, set the **Resolution** setting to **Wide** or **Normal** from the Configuration menu, according to the size of the computer panel.

🖱️ **Signal - Resolution** [p.120](#)

## Changing the Aspect Mode (EB-580/EB-570 only)

### Projecting Images from Video Equipment

Each time the [Aspect] button is pressed, the aspect mode changes in the order **4:3** and **16:9**.

When inputting a 720p/1080i signal and the aspect mode is set to **4:3**, a 4:3 zoom is applied (the right and left sides of the image are cut off).

Example: 720p signal input (resolution: 1280x720, aspect ratio: 16:9)

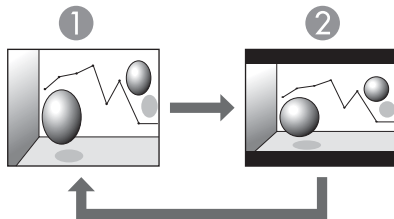

- ① 4:3
- ② 16:9

### Projecting Images from the HDMI/MHL Port

Each time the [Aspect] button is pressed, the aspect mode changes in the order **Auto**, **4:3**, and **16:9**.

Example: 1080p signal input (resolution: 1920x1080, aspect ratio: 16:9)

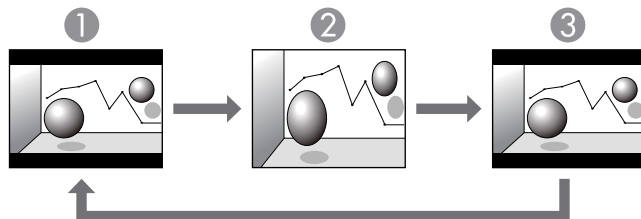

- ① Auto

- ② 4:3
- ③ 16:9

### Projecting Images from a Computer

Each time the [Aspect] button is pressed, the aspect mode changes in the order **Normal**, **4:3**, and **16:9**.

The following shows projection examples for each aspect mode.

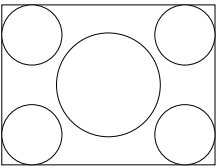
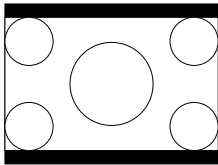
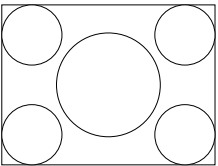
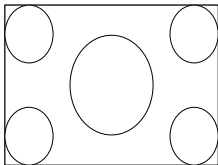
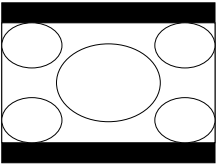
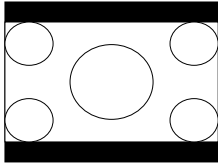
Aspect mode	Input Signal	
	XGA 1024X768(4:3)	WXGA 1280X800(16:10)
<b>Normal</b>		
<b>4:3</b>		
<b>16:9</b>		



If parts of the image are missing, set the **Resolution** setting to **Wide** or **Normal** from the Configuration menu, according to the size of the computer panel.

☞ **Signal - Resolution** [p.120](#)



## Using the Interactive Features (EB-585Wi/EB-575Wi only)

Follow the instructions in these sections to use the interactive features.

The interactive features turn any wall into an interactive whiteboard, either with or without a computer. Three interactive modes are available and it's easy to shift between each mode:

- In annotation mode, you can use interactive pens to add notes to content projected from a computer, tablet, document camera, or other source. This helps you emphasize projected information or include additional notes for more effective lessons or presentations.



- In whiteboard mode, you can use interactive pens to write on the projected "whiteboard." You do not need to use a computer or install any additional software to use the built-in whiteboard drawing feature.

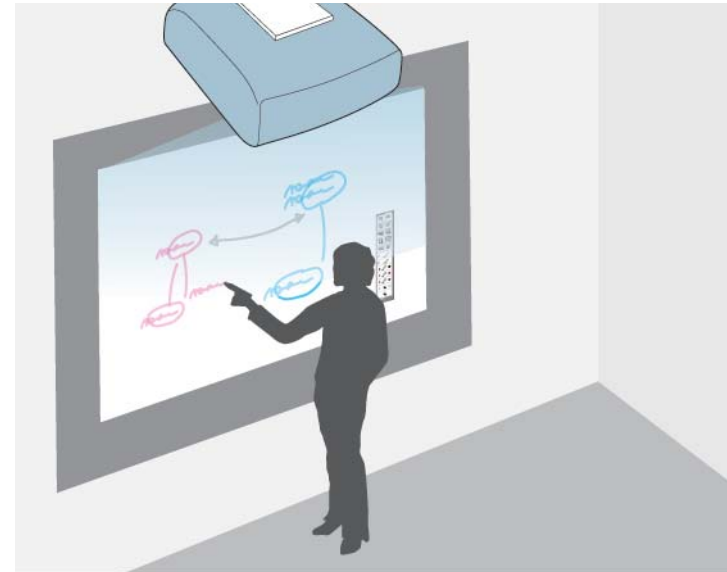

- In computer interactive mode, you can use interactive pens as you would use a mouse. This allows you to navigate, select, and scroll through content projected from your computer.

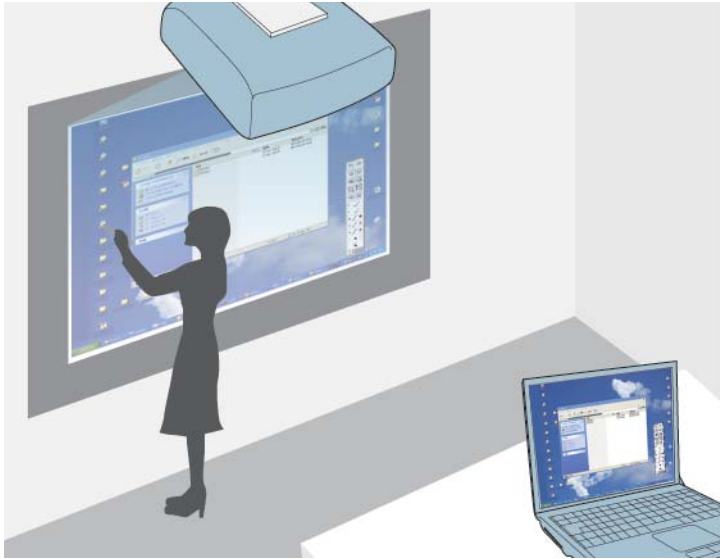

 You can also use the Easy Interactive Tools software to provide additional interactive features, such as saving your annotations, and then printing them. See the *Easy Interactive Tools Operation Guide* built into the software for instructions.



## Drawing on a Projected Image (Annotation Mode)

Annotation mode lets you project from a computer, tablet, video device, or other source and add notes to your projected content using the interactive pens. You can use both pens at the same time.

- 1** Turn on the projector.

- 2** Make sure you have calibrated the first time you use your projector.  
 "Pen Calibration" [p.71](#)

- 3** Project an image from a connected device.
- 4** Hold an interactive pen close to the projected screen.





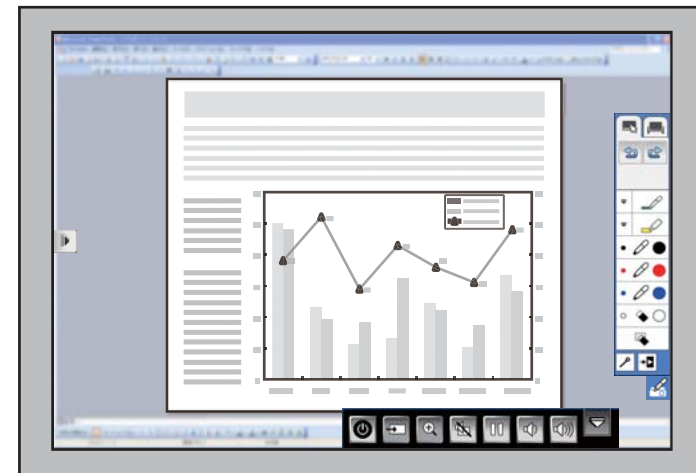

- 5** To write or draw, tap the  or  toolbar tab.

You see the toolbar on the projected image, for example:







- You can also control the projector from the projected screen by using the projector control toolbar displayed on the screen. Tap the  or  icon if the projector control toolbar is not displayed.
- You can move the  and  toolbar tabs up and down, and the  or  toolbar tab right and left.

You can write on the projected screen.

☞ "Using the Interactive Pens" [p.70](#)

☞ "Interacting with the Screen" [p.77](#)

## Using the Projected Screen as a Whiteboard (Whiteboard Mode)

You can use the interactive pens to write or draw on the projection surface just as you would on a chalkboard or dry erase board. You can use both pens at the same time.

- 1** Turn on the projector.
- 2** Make sure you have calibrated the first time you use your projector.
  - ☞ "Pen Calibration" [p.71](#)
- 3** Hold an interactive pen close to the projected screen.





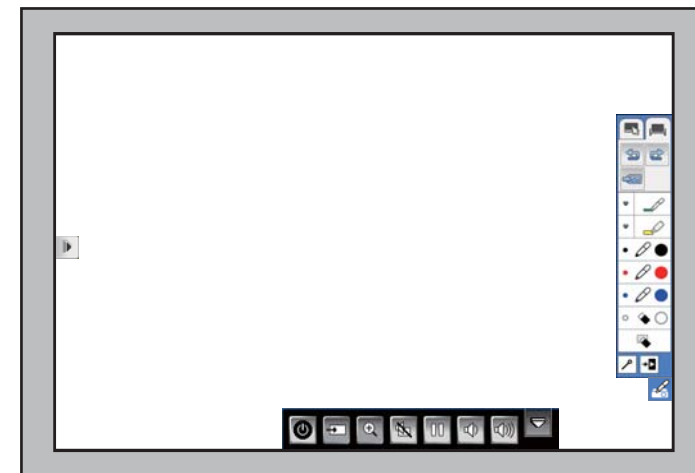

- 4** Tap the  or  toolbar tab.

The toolbar is displayed.

- 5** Tap the  icon on the toolbar.

You see the whiteboard screen and toolbar, for example:



- You can also control the projector from the projected screen by using the projector control toolbar displayed on the screen. Tap the  or  icon if the projector control toolbar is not displayed.
- You can move the  and  toolbar tabs up and down, and the  or  toolbar tab right and left.

**6** To write or draw on the screen, use the toolbar on the right or left side.

☛ "Using the Interactive Pens" [p.70](#)

☛ "Interacting with the Screen" [p.77](#)



You can also use the Easy Interactive Tools software to provide additional interactive features, such as treating the drawing area as a page, and creating multiple pages to draw on. See the *Easy Interactive Tools Operation Guide* for instructions.

## Controlling Computer Features from a Projected Screen (Computer Interactive Mode)

You can navigate, select, and interact with your computer programs from the projected screen using the interactive pens, just as you would with a mouse.

### Computer Interactive Mode System Requirements

Your computer must use one of the following operating systems to use the computer interactive mode.

Windows	Windows XP Service Pack 2 and Service Pack 3 <ul style="list-style-type: none"> <li>• Professional (32-bit)</li> <li>• Home Edition (32-bit)</li> <li>• Tablet PC Edition (32-bit)</li> </ul>
	Windows Vista Service Pack 2 <ul style="list-style-type: none"> <li>• Ultimate (32-bit)</li> <li>• Enterprise (32-bit)</li> <li>• Business (32-bit)</li> <li>• Home Premium (32-bit)</li> <li>• Home Basic (32-bit)</li> </ul>

	Windows 7 Service Pack 1 <ul style="list-style-type: none"> <li>• Ultimate (32- and 64-bit)</li> <li>• Enterprise (32- and 64-bit)</li> <li>• Professional (32- and 64-bit)</li> <li>• Home Premium (32- and 64-bit)</li> </ul>
	Windows 8 <ul style="list-style-type: none"> <li>• Windows 8 (32- and 64-bit)</li> <li>• Windows 8 Pro (32- and 64-bit)</li> <li>• Windows 8 Enterprise (32- and 64-bit)</li> </ul>
	Windows 8.1 <ul style="list-style-type: none"> <li>• Windows 8.1 (32- and 64-bit)</li> <li>• Windows 8.1 Pro (32- and 64-bit)</li> <li>• Windows 8.1 Enterprise (32- and 64-bit)</li> </ul>
Mac	OS X <ul style="list-style-type: none"> <li>• Mac OS X 10.5.x</li> <li>• Mac OS X 10.6.x</li> <li>• OS X 10.7.x</li> <li>• OS X 10.8.x</li> <li>• OS X 10.9.x</li> </ul>
Ubuntu	Ubuntu <ul style="list-style-type: none"> <li>• 12.04 LTS</li> <li>• 12.10</li> <li>• 13.04</li> <li>• 13.10</li> </ul>

### Using Computer Interactive Mode

You can control your computer programs with the projected screen using computer interactive mode.

To use computer interactive mode, connect your computer to the projector with the supplied USB cable.

For OS X, you need to install the Easy Interactive Driver to use computer interactive mode.



- When you use multiple displays with Windows 7 and use interactive features on the secondary display, make the following settings:
  - Set the **Pen Operation Mode** setting to **One User/Pen** in the **Easy Interactive Function** setting in the projector's **Extended** menu .
  - Go to **Control Panel > Hardware and Sound > Table PC Settings > Setup** to launch the setup program and configure the interactive features.

If you set up a third display, you cannot use interactive features with that display.

You cannot write or draw across multiple screens.
- To use computer interactive mode over a network, you need to install EasyMP Network Projection version 2.85 or later (for Windows) or 2.83 or later (for OS X), or Quick Wireless version 1.32 or later.

- 1 If you are using OS X, install the Easy Interactive Driver on your computer the first time you use the interactive features.
  - ☛ "Easy Interactive Driver System Requirements (OS X only)" [p.69](#)
  - ☛ "Installing Easy Interactive Driver on OS X" [p.69](#)

- 2 Connect the projector to your computer using a USB cable.



You do not need a USB cable when using computer interactive mode over a network.

☛ "Using the Interactive Features over a Network" [p.83](#)

- 3 Turn on the projector.
- 4 Project your computer screen.
- 5 Press the [Menu] button, select the **Extended** menu, and press the [Enter] button.

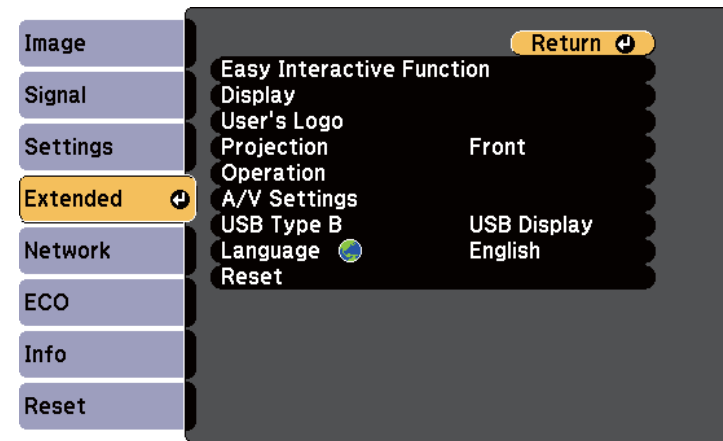

- 6 Select the **USB Type B** setting and press the [Enter] button.

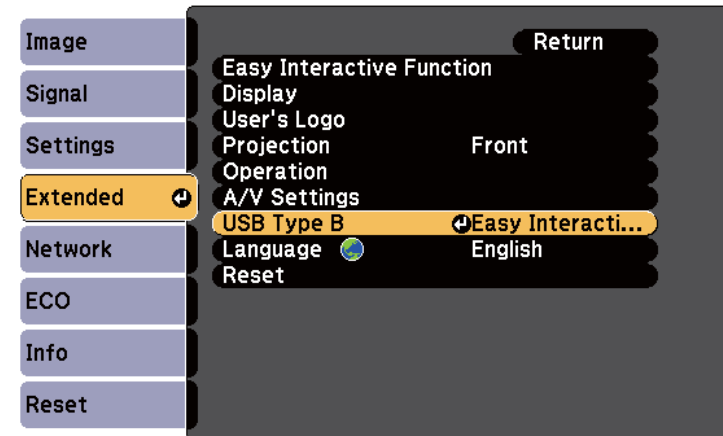

- 7 Select one of the following:
  - To use computer interactive mode, select **Easy Interactive Function**.
  - To use computer interactive mode and USB Display at the same time, select **USB Display/Easy Interactive Function**.



When projecting using USB Display, response time may be slower.

**8** Select the **Easy Interactive Function** setting and press the [Enter] button.

**9** Select either **Two Users/Mouse** or **One User/Mouse** as the **Pen Operation Mode** setting.

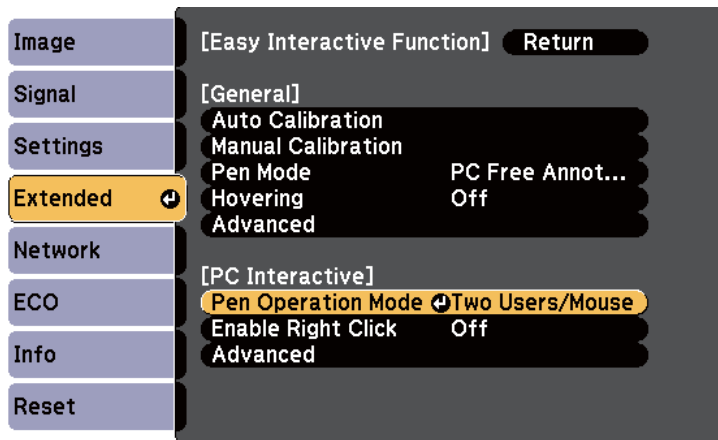

**10** Press the [Enter] button and press the [Menu] button to exit the projector's configuration menu.

**11** Make sure you have calibrated the first time you use your projector.

☛ "Pen Calibration" [p.71](#)



**12** Hold an interactive pen close to the projected screen.

The  icon is displayed on the projected screen.



- The  icon is displayed on the right for the first time. Next time, it is displayed on the side from which you last opened the toolbar.

- If the  icon is not displayed, set the **Pen Mode Icon** setting to **On** in the projector's **Extended** menu.  
☛ **Extended - Display - Pen Mode Icon** [p.123](#)

**13** Select the  icon, and then select the  icon.

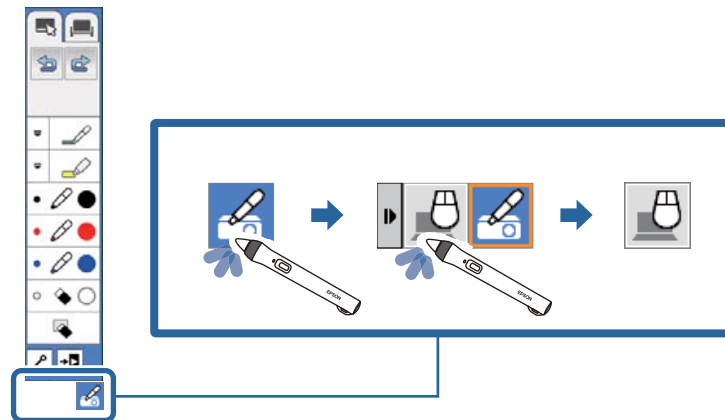

You can also change to computer interactive mode by doing the following:







- Pressing the [Pen Mode] button on the remote control.
- Changing the **Pen Mode** setting on the projector's **Extended** menu to **PC Interactive**.

☛ **Extended - Easy Interactive Function - Pen Mode** [p.126](#)

You can now operate the computer using the interactive pen.

- ☛ "Using the Interactive Pens" [p.70](#)
- ☛ "Interacting with the Screen" [p.77](#)
- ☛ "Using the Interactive Features over a Network" [p.83](#)



- You can also control the projector from the projected screen by using the projector control toolbar displayed on the screen. Tap the  or  icon if the projector control toolbar is not displayed.
- You can move the  and  toolbar tabs up and down, and the  or  toolbar tab right and left.
- You can also do the following in computer interactive mode:
  - Use the Tablet PC input panel in Windows 7 or Windows Vista.
  - Use Ink Tools for annotation in Microsoft Office applications.
- Using two interactive pens at the same time may cause interference in some application software. In that case, move any pen you are not using away from the projection screen.

## Easy Interactive Driver System Requirements (OS X only)

To use computer interactive mode, you must install the Easy Interactive Driver on your computer. Check the system requirements necessary to run the software.

Operating system	Mac OS X 10.5.x Mac OS X 10.6.x OS X 10.7.x OS X 10.8.x OS X 10.9.x
------------------	---

CPU	Power PC G4 1 GHz or faster (CoreDuo 1.83 GHz or faster recommended)
Memory	512 MB or more
Hard disk space	100 MB or more
Display	Resolution between 1024 × 768 (XGA) and 1920 × 1200 (WUXGA) 16-bit color or greater (approximately 32,000 display colors)

## Installing Easy Interactive Driver on OS X

Install Easy Interactive Driver on your computer to use computer interactive mode.



You may have already installed Easy Interactive Tools using the Easy Install option, which also installs Easy Interactive Driver. See the *Easy Interactive Tools Operation Guide* in the Document CD-ROM for details.

- 1** Turn on your computer.
- 2** Insert the EPSON Projector Software for Easy Interactive Function CD into the computer.  
You see the EPSON window.
- 3** Double-click the **Install Navi** icon in the EPSON window.
- 4** Select **Custom Install**.
- 5** Follow the on-screen instructions to install the software.
- 6** Restart your computer.

Your projector comes with a blue pen and an orange pen, identified by the color on the end of the pen. You can use either pen, or both at the same time (one of each color).

Make sure the pen batteries are installed.

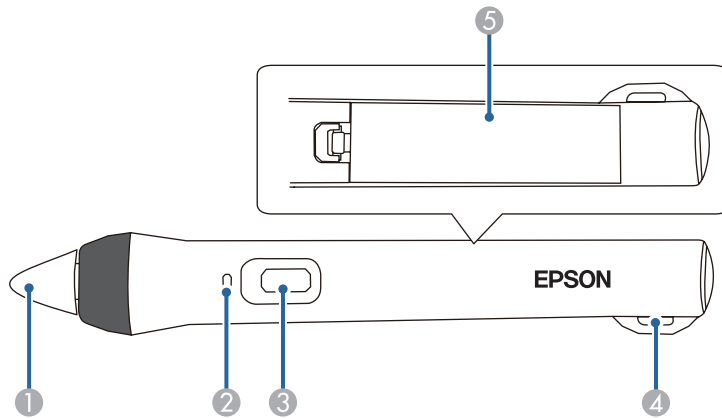

- ① Pen tip
- ② Battery light
- ③ Button
- ④ Attachment for optional strap or cord
- ⑤ Battery cover

To turn on the pen, tap the pen tip or press the button on the side.

When you are finished using the pen, leave the pen as it is far from the projection screen.

☛ "Interactive Pen (EB-585Wi/EB-575Wi only)" [p.20](#)

### Attention

- Do not use interactive pens with wet hands or in locations where the pens may get wet. The interactive pens are not waterproof.
- Keep the projector and projection screen out of direct sunlight, or the interactive features may not work.



- The pens turn off automatically after 20 minutes of inactivity. To turn a pen back on, tap the pen tip or press the button on the side.
- For best performance, hold the pen perpendicular to the board, as shown below. Do not cover the black band near the tip of the pen.

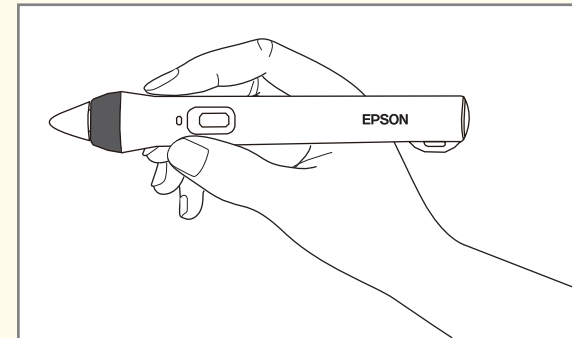

You can do the following using the pen:

- Write or draw on the projection surface in annotation mode and whiteboard mode.

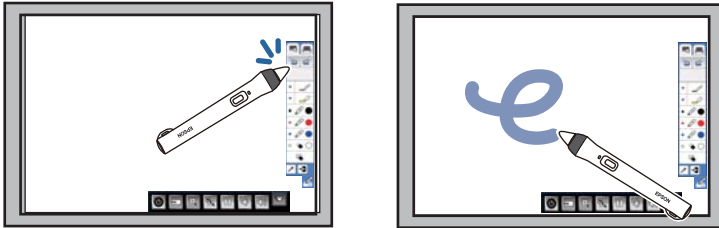

- To select a projected item, such as an icon, tap the projection surface with the pen tip.
- To draw on the projected screen, tap the projection surface with the pen and drag it as necessary.
- To move the projected pointer, hover over the surface without touching it.
- To switch the pen from a drawing tool to an eraser, press the button on the side.
- Use the pen as a mouse in computer interactive mode.



- To left-click, tap the board with the pen tip.
- To double-click, tap twice with the pen tip.
- To right-click, press the button on the side.
- To click and drag, tap and drag with the pen.
- To move the cursor, hover over the board without touching it.



- If you do not want to use the hovering feature, you can turn it off using the **Easy Interactive Function** setting in the projector's **Extended** menu.
  - **Extended - Easy Interactive Function - Hovering p.126**
- To make a long press of the pen act as a right-click, select the following settings in the **Easy Interactive Function** setting in the projector's **Extended** menu.
  - Set the **Pen Operation Mode** setting to **Two Users/Mouse** or **One User/Mouse** .
  - Set the **Enable Right Click** setting to **On**.

## Pen Calibration

Calibration coordinates the positioning of the pen with the location of your cursor. You only need to calibrate the first time you use your projector.

You can use **Auto Calibration** to calibrate the system, but **Manual Calibration** is also available for finer adjustments or if **Auto Calibration** failed.



- Move any pen you are not using away from the projection screen while calibrating the system.
- Calibrate the system again if you notice any discrepancy in positioning after doing any of the following:
  - Performing Keystone correction
  - Adjusting the image size
  - Using the Image Shift feature
  - Changing the projector position
- The calibration results remain until you recalibrate.

## Calibrating Automatically

You need to calibrate the first time you use your projector, and you do not need the pens or a computer for **Auto Calibration**.

- 1 Press the [Menu] button, select the **Extended** menu, and press the [Enter] button.

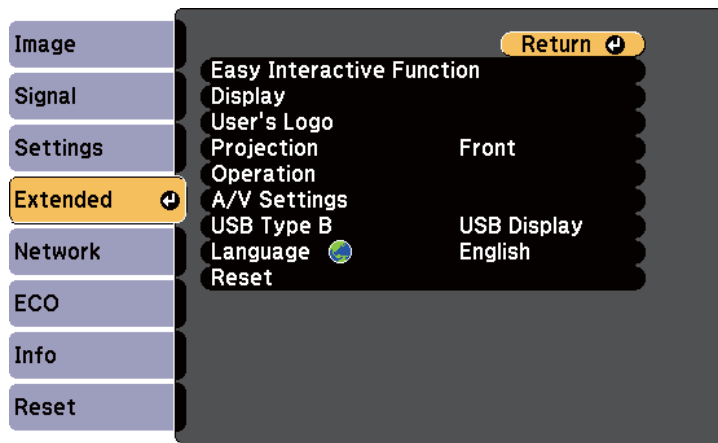

- 2 Select the **Easy Interactive Function** setting and press the [Enter] button.

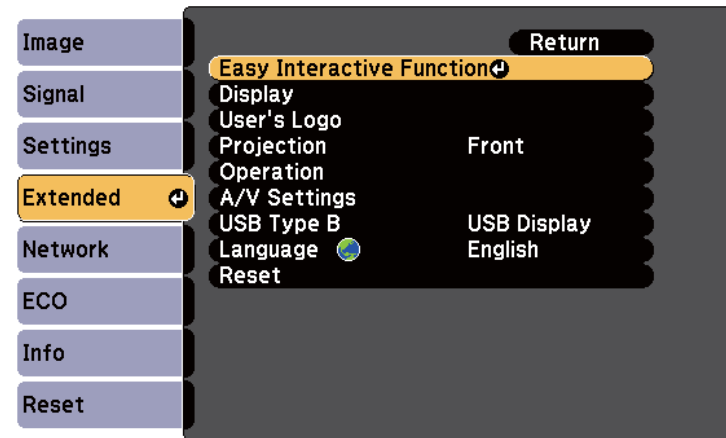

- 3 Select **Auto Calibration** and press the [Enter] button.

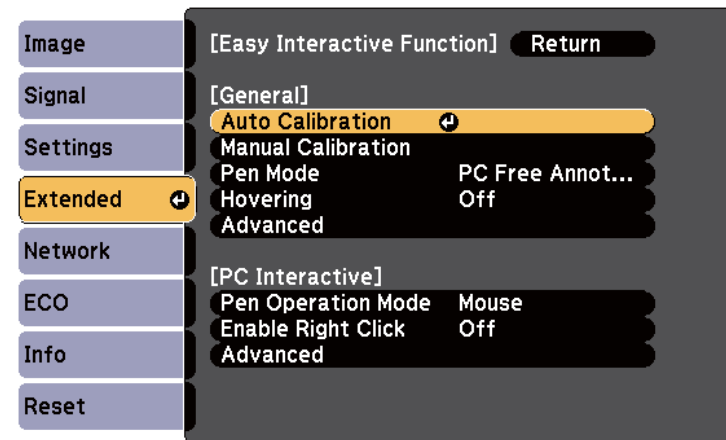

The following screen appears.



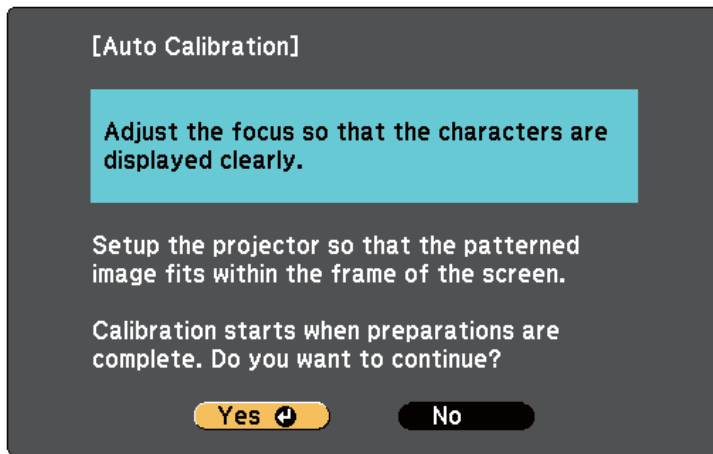

**4** Adjust the focus if necessary, by opening the air filter cover on the side of the projector and sliding the focus lever.

**5** Press the [Enter] button to select **Yes**.  
A pattern appears then disappears, and the system is calibrated. If you see a message that calibration failed, you need to calibrate manually.

The cursor location and pen position should match after calibration. If not, you may need to calibrate manually.

## Calibrating Manually

If the cursor location and pen position do not match after auto calibration, you can calibrate manually.

**1** Press the [Menu] button, select the **Extended** menu, and press the [Enter] button.

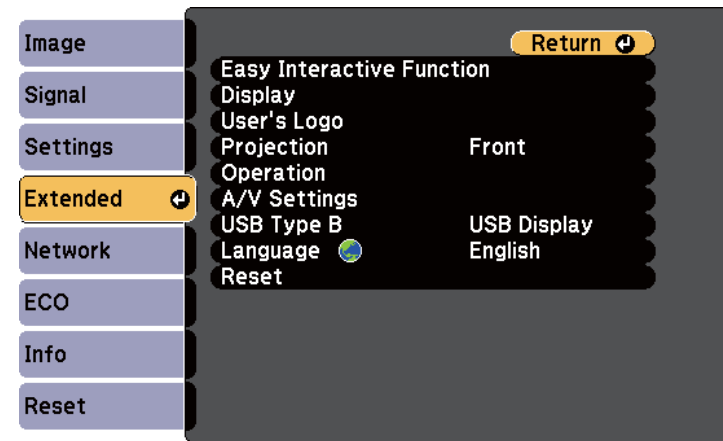

**2** Select the **Easy Interactive Function** setting and press the [Enter] button.

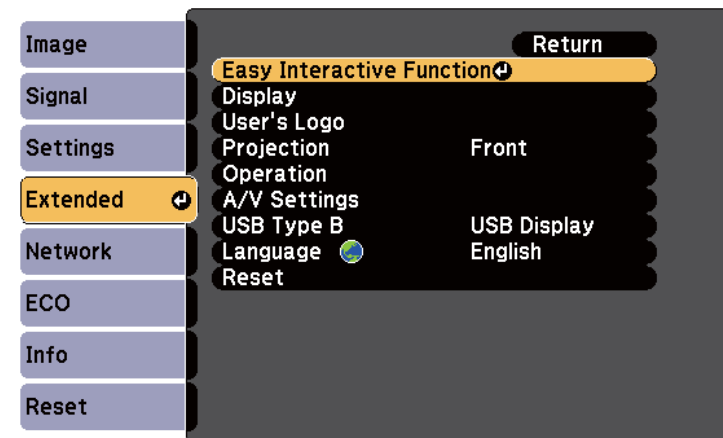

**3** Select **Manual Calibration** and press the [Enter] button.

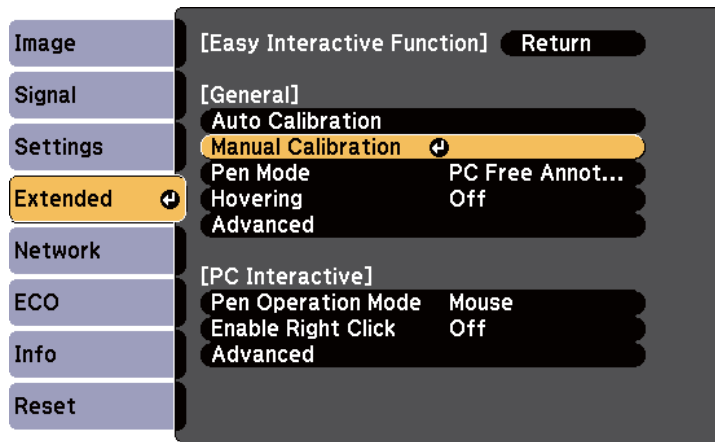

The following screen appears.

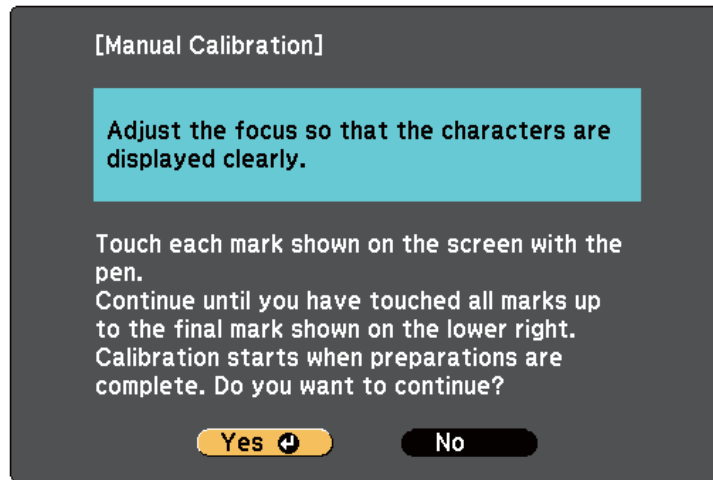

- 4 Adjust the focus if necessary, by opening the air filter cover on the side of the projector and sliding the focus lever.

- 5 Press the [Enter] button to select **Yes**.  
A flashing green circle appears in the upper left corner of your projected image.
- 6 Touch the center of the circle with the tip of the pen.  
The circle disappears, and you see another circle below the first one.

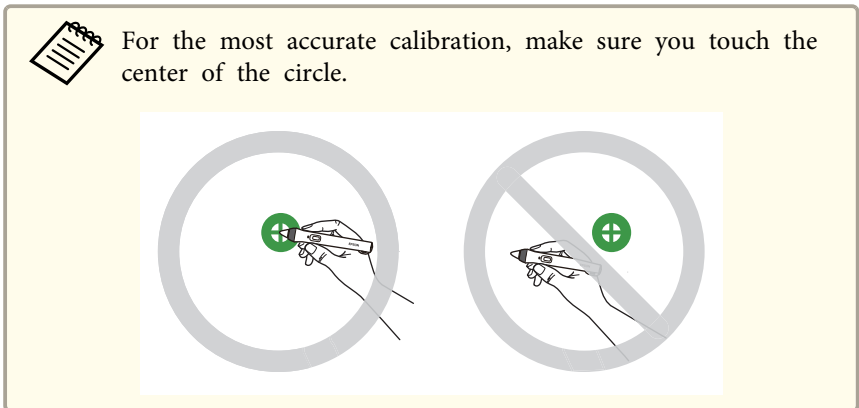
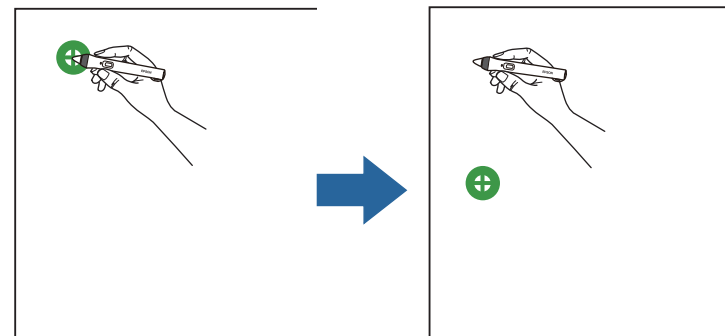

- 7 Touch the center of the next circle, then repeat. When you get to the bottom of the column, the next circle appears at the top of a new column.

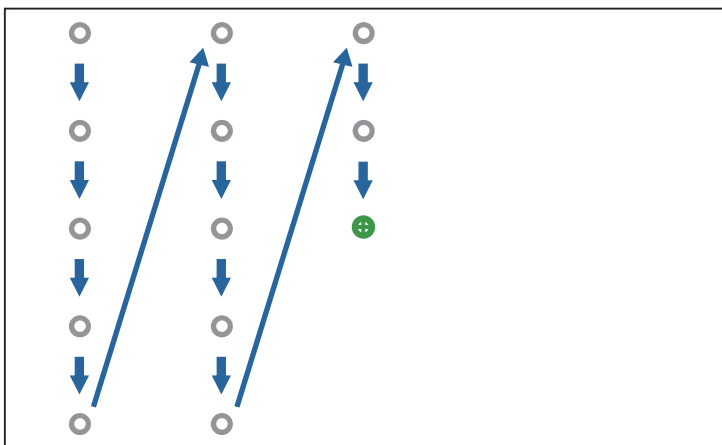

- Make sure you are not blocking the signal between the pen and the interactive receiver.
- If you make a mistake, press the [Esc] button on the remote control to go back to the previous circle.
- To cancel the calibration process, press and hold the [Esc] button for 2 seconds.

**8** Continue until all of the circles disappear.

## Adjusting the Pen Operation Area

The pen operation area is normally adjusted automatically if you connect a different computer or adjust the computer's resolution. If you notice that the pen position is incorrect when you operate your computer from the projected screen (computer interactive mode), you can adjust the pen area manually.



Manual adjustment is not available when projecting from a LAN source.

**1** Switch to computer interactive mode, if necessary.

☞ "Using Computer Interactive Mode" p.66

**2** Press the [Menu] button, select the **Extended** menu, and press the [Enter] button.

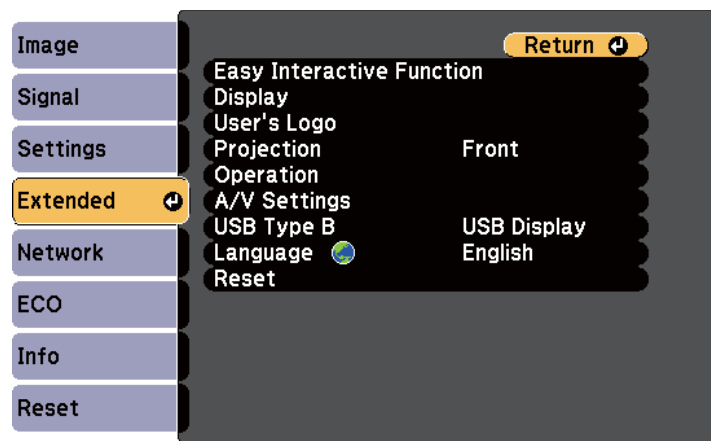

**3** Select the **Easy Interactive Function** setting and press the [Enter] button.

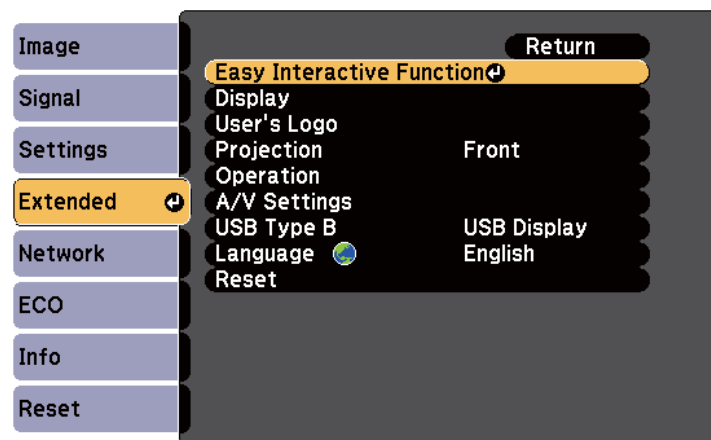

- 4** In the **PC Interactive** section, select **Advanced** and press the [Enter] button.

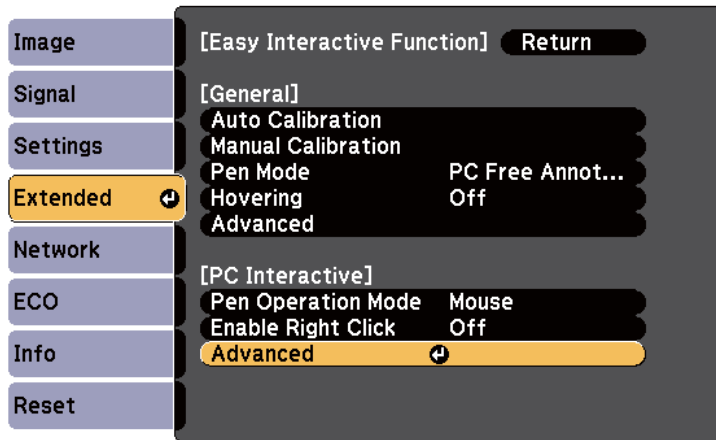

- 5** Select **Manual Adj. Pen Area** and press the [Enter] button.

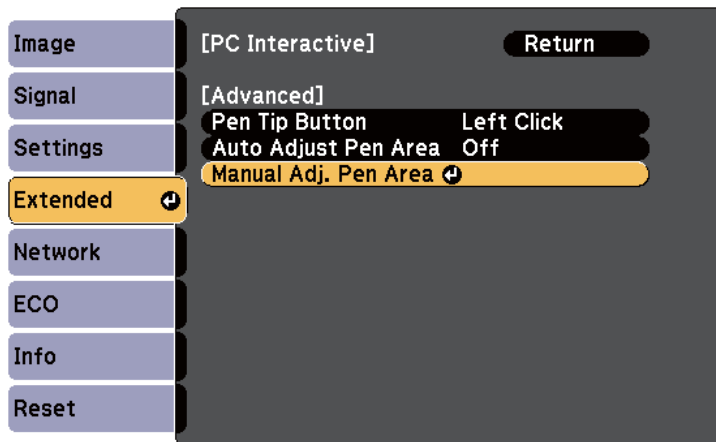

- 6** Press the [Enter] button to select **Yes**.

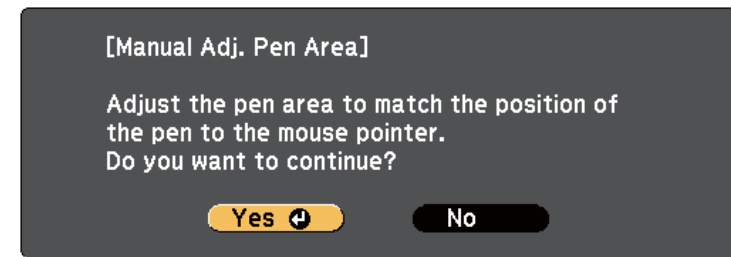

The mouse pointer moves toward the top left corner.

- 7** When the mouse pointer stops at the top left corner of the image, touch the tip of the pointer with the pen.

The mouse pointer moves toward the bottom right corner.

- 8** When the mouse pointer stops at the bottom right corner of the image, touch the tip of the pointer with the pen.

Follow these instructions to interact with the projected image or control the projector.

## Switching the Interactive Mode

You can easily switch the interactive mode using the toolbar.

- To switch between computer interactive mode and annotation mode, select one of the following icons:
  - To change from annotation mode or whiteboard mode to computer interactive mode:

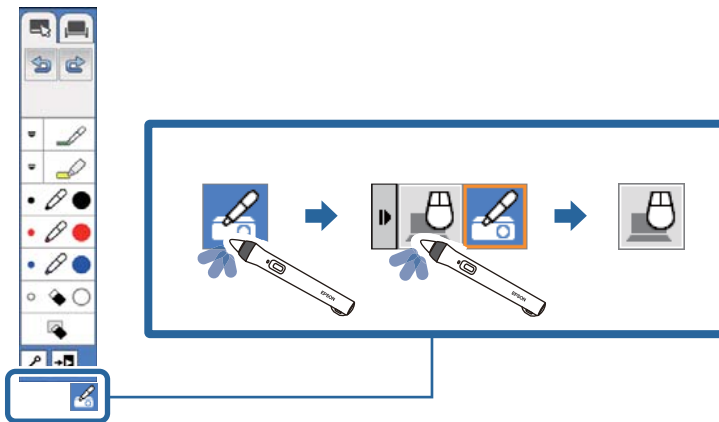

- To change from computer interactive mode to annotation mode or whiteboard mode:



- To switch between annotation mode and whiteboard mode, select the following icon in the toolbar.

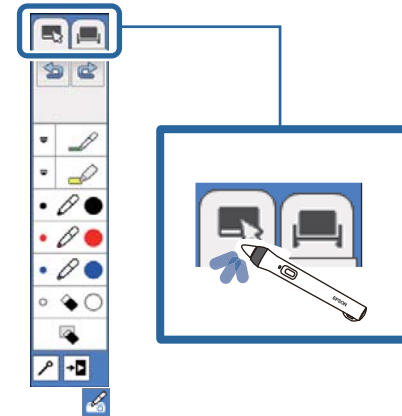





- You can also change the interactive mode by doing the following:
  - Pressing the [Pen Mode] button on the remote control.
  - Switching to **PC Free Annotation** or **PC Interactive** in the **Pen Mode** setting on the projector's **Extended** menu.
    - ☛ **Extended - Easy Interactive Function - Pen Mode** [p.126](#)
- You can switch to computer interactive mode when you project the computer screen.
- You cannot switch to computer interactive mode when the **USB Type B** setting in the projector's **Extended** menu is set to **Wireless Mouse/USB Display**.
- The computer screen is projected when you switch to computer interactive mode from whiteboard mode.
- After changing to computer interactive mode, content drawn using annotation mode is retained.



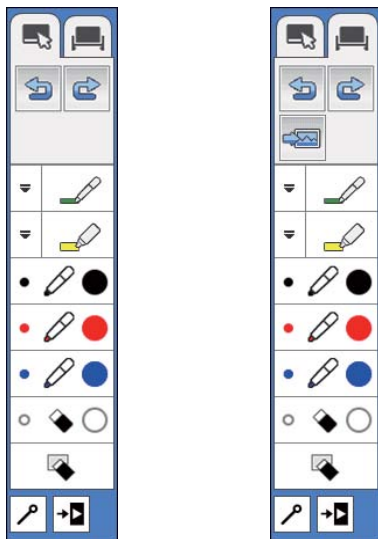





## Annotation Mode and Whiteboard Mode Toolbars

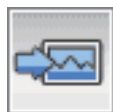

The annotation mode toolbar or the whiteboard mode toolbar lets you draw and write on the projected screen. The toolbar also lets you easily switch to annotation or whiteboard mode.

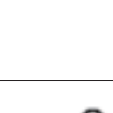
In the following illustration, the annotation mode toolbar is shown on the left, and the whiteboard mode toolbar on the right:

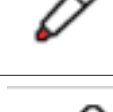

	Switches to annotation mode.
	Switches to whiteboard mode.
	Undoes the last operation.

	Redoes the last undo.
	Selects a white or black background or one of four patterns (whiteboard mode only). ☛ "Selecting Whiteboard Templates" <a href="#">p.80</a>
	Writes or draws free-form lines with custom pen. Select the  icon to change custom pen color and width. ☛ "Selecting Line Width and Color" <a href="#">p.79</a>
	Writes or draws free-form lines with a transparent highlighter pen. Select the  icon to change highlighter pen color and width. ☛ "Selecting Line Width and Color" <a href="#">p.79</a>
	Black pen (fine point on left, thick on right).
	Red pen (fine point on left, thick on right).
	Blue pen (fine point on left, thick on right).
	Eraser (thin width on left, thick on right).

	Clears all drawings.
	Hides the toolbar after each drawing.
	Closes the toolbar.

## Selecting Line Width and Color

You can select the color and line width for both the custom Pen and the Highlighter tools.

- 1 Select the  icon next to the custom Pen or Highlighter annotation tool.

A box like the following appears:



- 2 Select the line width and color you want to use for the Pen or Highlighter tools.



- As you hover over the color palette, the name of the color is displayed at the bottom of the palette.
- You can change the shade of the color palette using the **Color Palette** setting in the projector's **Extended** menu.  
 **Extended - Easy Interactive Function - General - Advanced - Color Palette** [p.126](#)

- 3 Select the  or  tool, then use the pen to write or draw on the projection surface.



When multiple people draw on the projected screen using the multiple pens, you can select different colors and line widths for each pen.

## Selecting Whiteboard Templates

In whiteboard mode, you can change the background color, and insert horizontal lines or a background template.

**1** In whiteboard mode, select the  icon.

The following box appears.

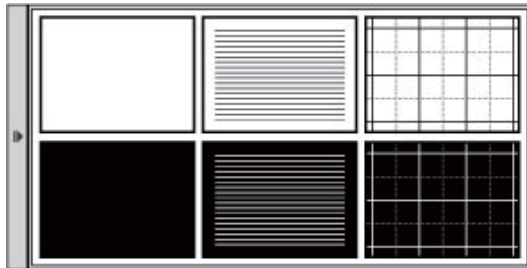









**2** Select one of the template patterns.

## Projector Control Toolbar

The projector control toolbar lets you control the projector from the projected screen just as you would using the remote control.

If your network device is connected to the projector using EasyMP Multi PC Projection, you can also use the toolbar to select the network device from which you want to project.





	Turns off the projector.
	Changes the image source using the displayed list. To close the image source list, select the  icon at the bottom of the list.
	Zooms into and out of the image using the scale or the + and - icons in the displayed list. You can do the following: <ul style="list-style-type: none"> <li>• The image can be enlarged to between 1 to 4 times. To return to the original image size, select <b>x1</b>.</li> <li>• You can expand and reduce quickly by holding down the + or - icon.</li> </ul> To close the scale list, select the  icon at the bottom of the list.
	Turns off picture and sound. Tap the projected screen to turn the video and audio on. ☛ "Hiding the Image and Sound Temporarily (A/V Mute)" <a href="#">p.93</a>
	Pauses video action. ☛ "Freezing the Image (Freeze)" <a href="#">p.93</a>
	Decreases the volume. ☛ "Adjusting the Volume" <a href="#">p.57</a>
	Increases the volume. ☛ "Adjusting the Volume" <a href="#">p.57</a>



	<p>Closes the projection control toolbar.</p>
---	---

## Selecting Network Device Display from the Projector Control Toolbar

If you have connected devices to the projector via a network, you can select to project an image from those devices using the projector control toolbar. You can select the image source from computers that are running EasyMP Multi PC Projection, and smartphones or tablets that are running Epson iProjection. You can change the projected screen by selecting from among up to 50 devices.

	<p>You can select any connected network device for projection, even if the user connected using the EasyMP Multi PC Projection software with the moderator feature enabled. See the <i>EasyMP Multi PC Projection Operation Guide</i> for details about the moderator feature.</p> <p> <a href="#">EasyMP Multi PC Projection Operation Guide</a></p>
---	--

- 1 Select the  icon on the projector control toolbar, and then select **Participant List** from the image source list.

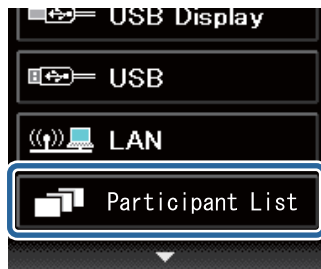

- 2 Select the user name for the device you want to project from.

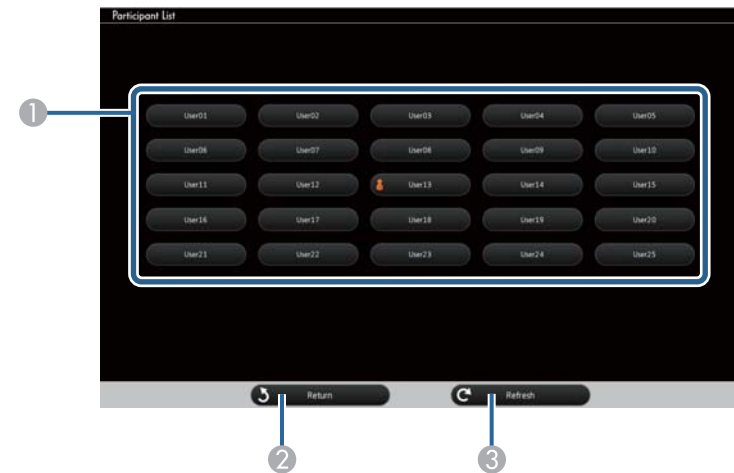

- 1 Displays the user names for network devices connected to the projector.  
The  icon is shown next to the user name of the currently projected device.
- 2 Closes the user selection screen and returns to the previous screen.
- 3 Refreshes the user list.  
When an additional user connects to the projector via a network, select this button to update the user list.



- When the selected device is disconnected from the projector, the selected user's screen is not projected and the user list is automatically updated.
- While the user selection screen is displayed, you cannot do the following:
  - Select a different image source
  - Use other interactive features
  - Control the projector from the projector control toolbar
  - Connect to multiple projectors
  - Hear sound from the projector (it is turned off temporarily)
  - Change the settings using the projector's configuration menu
  - Project an image using EasyMP Multi PC Projection or Epson iProjection

You see the selected user's screen image.

When you change the user, repeat these steps.



- You cannot access the user selection screen when connecting to multiple projectors by using EasyMP Multi PC Projection and projecting the same image (mirroring).
- If the interactive features do not work, you can return to the previous screen by pressing the [Esc] button on the remote control or the control panel.

You can use your projector in computer interactive mode over a network.

If you want to annotate when using computer interactive mode over a network, you need to use Easy Interactive Tools (or another annotation program). Easy Interactive Tools allows you to use various drawing tools, treat the drawing area as a page, and save your drawings as a file for a later use. You can install Easy Interactive Tools from the EPSON Projector Software for Easy Interactive Function CD. You can also download the software from the Epson website.

- Use one of the following software applications to setup your projector on a computer network and use computer interactive mode over the network:
  - EasyMP Network Projection version 2.85 or later (for Windows) or 2.83 or later (for OS X)  
See the *EasyMP Network Projection Operation Guide* for instructions.  
[EasyMP Network Projection Operation Guide](#)
  - Quick Wireless version 1.32 or later (Windows only)  
See the instructions included with the optional Quick Wireless Connection USB Key.
- With either application, select **Use Interactive Pen** on the **General settings** tab and **Transfer layered window** on the **Adjust performance** tab.



- You can only use one pen at a time.
- The response may be slower over the network.
- When using computer interactive mode over a network, you cannot change the **Pen Mode** setting using the remote control or from the projector's **Extended** menu. The  icon is also not available.
- You cannot change the **Pen Operation Mode** setting from the projector's **Extended** menu.
- You can connect up to four projectors at one time using EasyMP Network Projection. When connected to multiple projectors, computer interactive mode functions for any projector. Operations performed on one projector are reflected in other projectors.
- To use annotation mode over the network, clear **Use Interactive Pen** on the **General settings** tab and **Transfer layered window** on the **Adjust performance** tab in EasyMP Network Projection or Quick Wireless Connection, and then reconnect to the network.

## Precautions When Connecting to a Projector on a Different Subnet

Follow these precautions when you connect to a projector on a different subnet using EasyMP Network Projection and use interactive features:

- Search for the projector on the network by specifying the projector's IP address. You cannot search for it by specifying the projector name.
- Make sure that you get an echo reply back from the network projector when sending an echo request by the ping command. When the Internet Control Message Protocol (ICMP) option is disabled on the router, you can connect to the projector at remote locations even if you cannot get the echo reply back.

- Make sure the following ports are opened.

Port	Protocol	Usage	Communication
3620	TCP/UDP	For connection and control	Duplex
3621	TCP	For transferring images	Duplex
3629	TCP	For controlling projector	Duplex

- Make sure that the MAC address filtering and application filtering options are disabled on the router.
- Make sure that Network Address Translation (NAT) technology is not used in your network environment. With Internet VPN and IP-VPN, you can connect to the network projector remotely when you meet the above requirements.
- When bandwidth management is applied for communications between locations, and EasyMP Network Projection goes over the controlled bandwidth, you may not be able to connect to the projector at remote locations.



Epson does not guarantee the connection to the projector on a different subnet using EasyMP Network Projection even if you meet the above requirements. When considering the implementation, be sure to test the connection in your network environment.

If you are using Windows 8.1, Windows 8, Windows 7, or Windows Vista, you can use the pen input and Ink tools to add handwritten input and annotations to your work.

You can also use the pen input and Ink features over a network when you set the interactive features to be available on your network.

## Enabling Windows Pen Input and Ink Features

If you want to use the pen input and Ink features in Windows 8.1, Windows 8, Windows 7, or Windows Vista, you need to adjust the pen settings in the projector's **Extended** menu.

- 1 Press the [Menu] button, select the **Extended** menu, and press the [Enter] button.

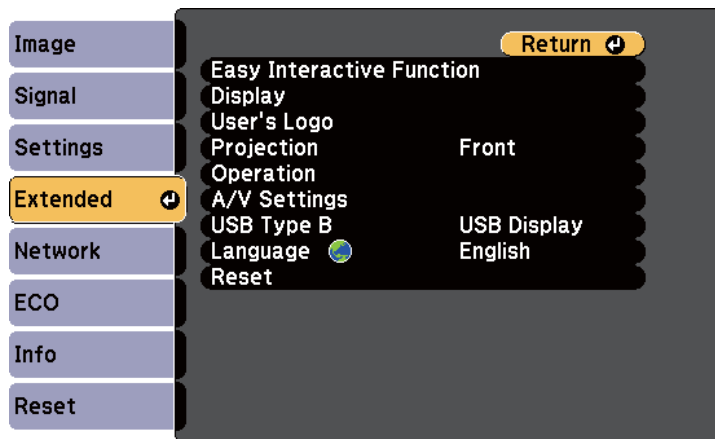

- 2 Select the **Easy Interactive Function** setting and press the [Enter] button.

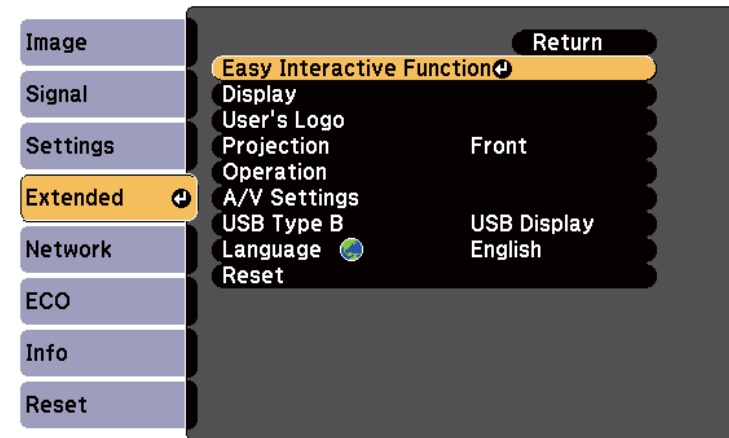

- 3 Select the **Pen Operation Mode** setting and press the [Enter] button.

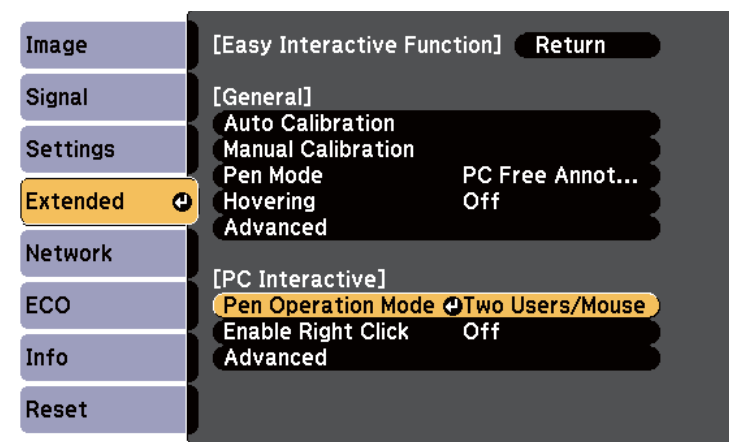

- 4 Select **One User/Pen** and press the [Enter] button.

## Using Windows Pen Input and Ink Features

If you are using Windows 8.1, Windows 8, Windows 7, or Windows Vista, you can add handwritten input and convert it to text.

If you have Microsoft Office 2007 or later, you can also use the Ink function to add handwritten notes to a Word document, Excel spreadsheet, or PowerPoint presentation.



Option names for the annotation functions may vary depending on your version of Microsoft Office.

- To open the Touch Keyboard in Windows 8, right-click or tap and hold on the Taskbar, then select **Toolbars > Touch Keyboard**. Select the keyboard icon on the screen, then select the pen icon.
- To open the Tablet PC input panel in Windows 7 or Windows Vista, select  > **All Programs > Accessories > Tablet PC > Tablet PC Input Panel**.

You can write in the box using the pen, then select from a variety of options to edit and convert the text.

- To add Ink annotations in Microsoft Office applications, select the **Review** menu, then select **Start Inking**.



In Microsoft Word or Excel, select the **Insert** tab and then click on **Start Inking**.

- To annotate your PowerPoint slides in Slideshow mode, press the button on the side of the pen, then select **Pointer Options > Pen** from the pop-up menu.



This method for annotating PowerPoint slides in Slideshow mode also works with Windows XP Tablet PC Edition.

For more information about these features, see your Windows Help.



# Useful Functions

This chapter explains useful functions for giving presentations and so on, and the security functions.

## Projecting Images Stored on a USB Storage Device (PC Free)

By connecting a USB storage device such as a USB memory or a USB hard disk to the projector, you can project the files stored on the device without using a computer. This function is called PC Free.



- You may not be able to use USB storage devices that incorporate security functions.
- You cannot correct keystone distortion while projecting in PC Free, even if you press the [↕] and [↔] buttons on the control panel.

### Specifications for Files that Can Be Projected Using PC Free

Type	File Type (Extension)	Notes
Image	.jpg	The following cannot be projected. - CMYK color mode format - Progressive format - Images with a resolution greater than 8192x8192 Due to the characteristics of JPEG files, images may not be projected clearly if the compression ratio is too high.
	.bmp	Cannot project images with a resolution greater than 1280x800.
	.gif	<ul style="list-style-type: none"> <li>• Cannot project images with a resolution greater than 1280x800.</li> <li>• Cannot project animated GIFs.</li> </ul>
	.png	Cannot project images with a resolution greater than 1280x800.

Type	File Type (Extension)	Notes
	.avi (Motion JPEG)	<ul style="list-style-type: none"> <li>• Cannot project images with a resolution greater than 1280 x 720.</li> <li>• You can only playback the audio formatted with linear PCM and ADPCM.</li> <li>• Supports AVI 1.0. You cannot project files over 2 GB.</li> </ul>



- When connecting and using a USB-compatible hard disk, make sure you connect the AC adaptor supplied with the hard disk.
- The projector does not support some file systems, so use media that has been formatted in Windows.
- Format the media in FAT16/32.

### PC Free Examples

#### Projecting Images Stored on USB Storage



☛ "Projecting the Selected Images or Movies" [p.90](#)

☛ "Projecting Image Files in a Folder in Sequence (Slideshow)" [p.91](#)



## PC Free Operating Methods





Although the following steps are explained based on the remote control, you can perform the same operations from the control panel.

### Starting PC Free

- 1** Change the source to USB.
  - ☛ "Switching to the Target Image Using the Remote Control" p.46
- 2** Connect the USB storage device to the projector.
  - ☛ "Connecting USB Devices" p.34

PC Free starts and the file list screen is displayed.

  - The following files are displayed as thumbnails (file contents are displayed as small images).
    - JPEG files
    - AVI files (displays the image at the start of the movie)
  - Other files or folders are displayed as icons as shown in the following table.

Icon	File	Icon	File
	JPEG files*		BMP files
	GIF files		PNG files
	AVI (Motion JPEG) files*		

\* When it cannot be displayed as a thumbnail, it is displayed as an icon.



- You can also insert a memory card into a USB card reader and then connect the reader to the projector. However, some commercially available USB card readers may not be compatible with the projector.
- If the following screen (Select Drive screen) is displayed, use the [▲], [▼], [◀], and [▶] buttons to select the drive you want to use, and then press the [Enter] button.

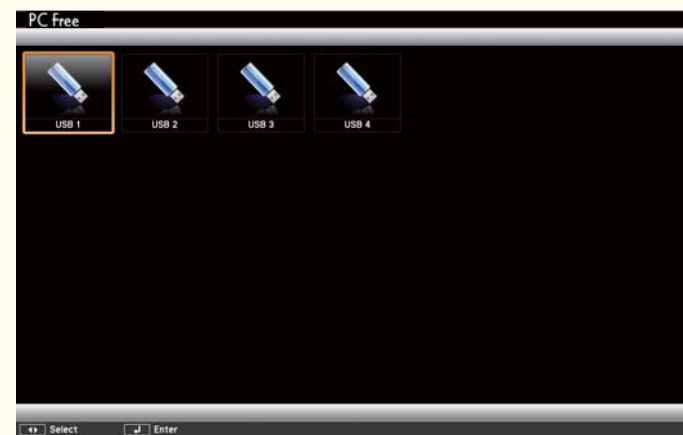

- To display the Select Drive screen, position the cursor on **Select Drive** at the top of the file list screen, and then press the [Enter] button.

### Projecting Images

- 1** Use the [▲], [▼], [◀], and [▶] buttons to select the file or folder you want to project.



If not all of the files and folders are displayed on the current screen, press the [↓] button on the remote control, or position the cursor on **Next Page** at the bottom of the screen and press the [Enter] button.

To return to the previous screen, press the [↑] button on the remote control, or position the cursor on **Previous Page** at the top of the screen and press the [Enter] button.

## 2 Press the [Enter] button.

The selected image is displayed.

When a folder is selected, the files in the selected folder are displayed. To return to the screen which was displayed before opening the folder, position the cursor on **Back to Top** and press the [Enter] button.

### Rotating Images

You can rotate the played images in 90° increments. The rotating function is also available during PC Free.

## 1 Play images, or run PC Free.

## 2 While projecting, press the [↶] or [↷] button.

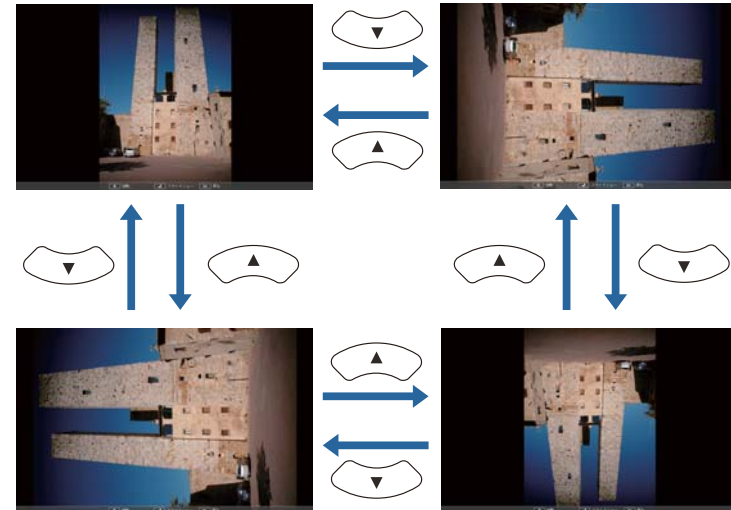

### Stopping PC Free

To close PC Free, disconnect the USB device from the USB port on the projector. For devices such as digital cameras or hard disks, turn off the device and then remove it from the projector.

### Projecting the Selected Images or Movies

#### Attention

Do not disconnect the USB storage device while it is being accessed. PC Free may not operate correctly.

## 1 Start PC Free. The file list screen is displayed.

👉 "Starting PC Free" [p.89](#)

- 2** Use the [▲], [▼], [◀], and [▶] buttons to select the image file you want to project.



- 3** Press the [Enter] button. The image is displayed.



Use the [◀] or [▶] buttons to move to the next or previous image file.

- 4** To finish projecting, perform one of the following operations.
- Projecting an image: Press the [Esc] button.
  - Projecting a movie: Press the [Esc] button to display the message screen, select **Exit**, and then press the [Enter] button.

When projection is finished, you are returned to the file list screen.

## Projecting Image Files in a Folder in Sequence (Slideshow)

You can project the image files in a folder in sequence, one at a time. This function is called Slideshow. Use the following procedure to run Slideshow.



To change files automatically when you run PC Free, set **Screen Switching Time** from **Option** to anything other than **No**. The default setting is 3 Seconds.



☛ "Image File Display Settings and Slideshow Operation Settings" p.92

- 1** Start PC Free. The file list screen is displayed. ☛ "Starting PC Free" p.89
- 2** Use the [▲], [▼], [◀], and [▶] buttons to position the cursor on the folder you want to run the Slideshow, and then press the [Enter] button.
- 3** Select **Slideshow** at the bottom of the file list screen, and then press the [Enter] button. Slideshow starts, and the image files in the folder are automatically projected in sequence, one at a time. When the last file is projected, the file list is displayed again automatically. If you set **Continuous Play** to **On** in the Option

screen, projection starts again from the beginning when it reaches the end.

☛ "Image File Display Settings and Slideshow Operation Settings" [p.92](#)

You can proceed to the next screen, return to the previous screen, or stop playback while projecting a Slideshow.

 If **Screen Switching Time** on the Option screen is set to **No**, files do not change automatically when you select Play Slideshow. Press the  button, the [Enter] button, or the  button to continue to the next file.

You can use the following functions when projecting an image file with PC Free.

- Freeze
  - ☛ "Freezing the Image (Freeze)" [p.93](#)
- A/V Mute
  - ☛ "Hiding the Image and Sound Temporarily (A/V Mute)" [p.93](#)
- E-Zoom
  - ☛ "Enlarging Part of the Image (E-Zoom)" [p.94](#)

## Image File Display Settings and Slideshow Operation Settings

You can set the file display order and Slideshow operations on the Option screen.

- 1** Select **Option** at the bottom of the file list screen, and then press the [Enter] button.



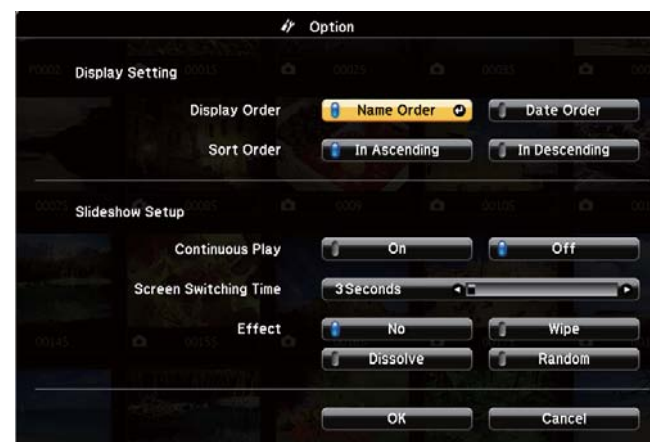

- 2** When the following Option screen is displayed, set each of the items.

Enable the settings by positioning the cursor on the target item and pressing the [Enter] button.

The following table shows the details for each item.



<b>Display Order</b>	You can select to display the files in <b>Name Order</b> or <b>Date Order</b> .
<b>Sort Order</b>	You can select to sort the files <b>In Ascending</b> or <b>In Descending</b> order.
<b>Continuous Play</b>	You can set whether to repeat the Slideshow.
<b>Screen Switching Time</b>	You can set the time for a single file to be displayed in Play Slideshow. You can set a time between <b>No</b> (0) to 60 seconds. When you set <b>No</b> , auto play is disabled.
<b>Effect</b>	You can set the screen effects when changing slides.

**3** Use the [, [, [, and [] buttons to position the cursor over **OK**, and then press the [Enter] button.

The settings are applied.

If you do not want to apply the settings, position the cursor on **Cancel**, and then press the [Enter] button.

## Hiding the Image and Sound Temporarily (A/V Mute)

You can switch off the image on the screen when you want to focus the audience's attention on what you are saying, or when you do not want to display operations such as changing files.

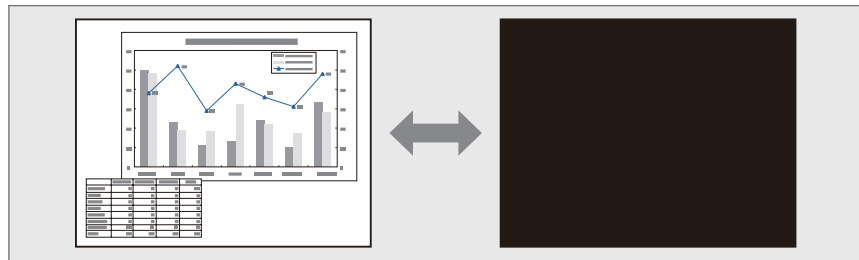

Each time you press the [A/V Mute] button, A/V Mute turns on or off.

### Remote control

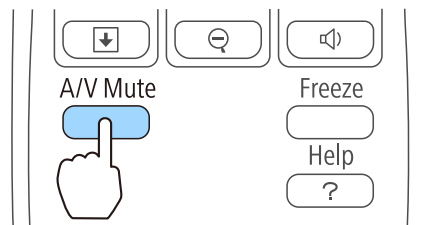

- If you use this function when projecting moving images, the images and sound continue to be played back by the source, and you cannot return to the point where A/V Mute was activated.
- Microphone audio is still output even when A/V Mute is turned on.
- You can select the screen displayed when the [A/V Mute] button is pressed from the Configuration menu.
  - ☛ **Extended - Display - A/V Mute** p.123
- When A/V mute is enabled with the [A/V Mute] button, **A/V Mute Timer** activates and the power is automatically turned off after approximately 30 minutes. If you do not want to enable **A/V Mute Timer**, set **A/V Mute Timer** to **Off**.
  - ☛ **ECO - A/V Mute Timer** p.135
- The lamp is still lit during A/V Mute, so the lamp hours continue to accumulate.

## Freezing the Image (Freeze)

When Freeze is activated on moving images, the frozen image continues to project on the screen, so you can project a moving image one frame at a time like a still photo. Also, you can perform operations such as changing between files during presentations from a computer without projecting any images if the Freeze function is activated beforehand.

Each time you press the [Freeze] button, Freeze turns on or off.

### Remote control

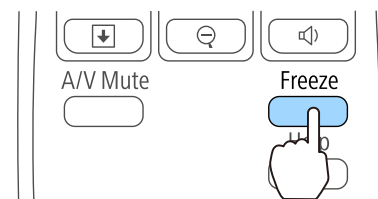



- Audio does not stop.
- For moving images, the images continue to play back while the screen is frozen, so it is not possible to resume projection from the point where the screen was frozen.
- If the [Freeze] button is pressed while the Configuration menu or the Help screen is displayed, the menu or the Help screen that is displayed is closed.
- Freeze still works while E-Zoom is being used.

## Pointer Function (Pointer)

This allows you to move a pointer icon on the projected image, and helps you draw attention to the area you are talking about.

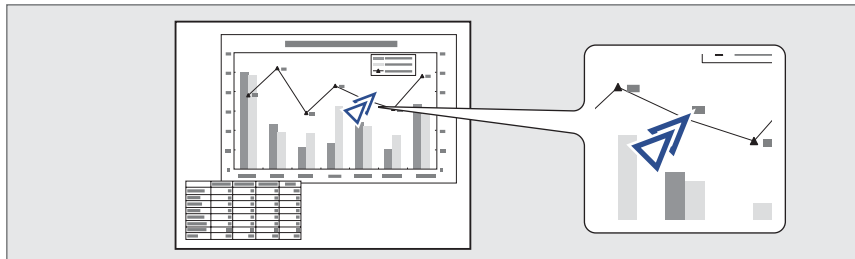

### 1 Display the Pointer.

Each time you press the [Pointer] button, the pointer appears or disappears.

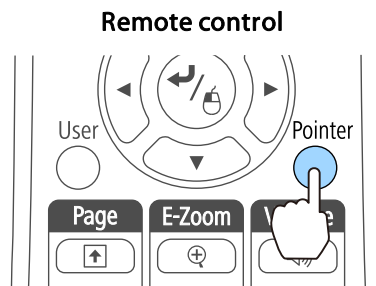

### 2 Move the Pointer icon (↗).

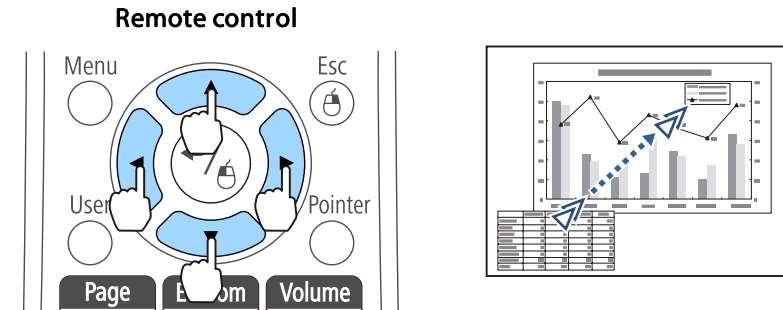

When any pair of adjacent [↖], [↘], [↙], or [↗] buttons are pressed at the same time, the pointer can be moved diagonally.



You can select the shape of the pointer icon from the Configuration menu.

🖱️ **Settings - Pointer Shape** [p.122](#)

## Enlarging Part of the Image (E-Zoom)

This is useful when you want to expand images to see them in greater detail, such as graphs and tables.

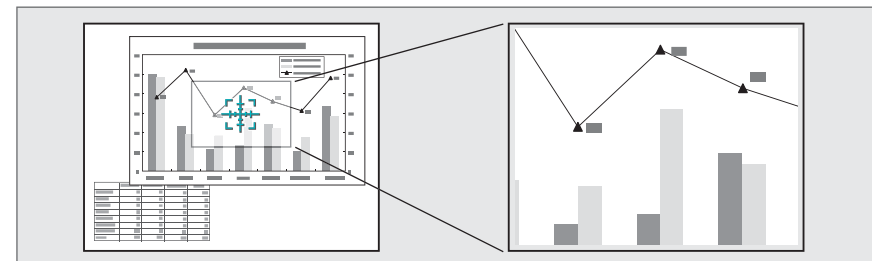

## 1 Start E-Zoom.

Press the [⊕] button to display the Cross (⊕).

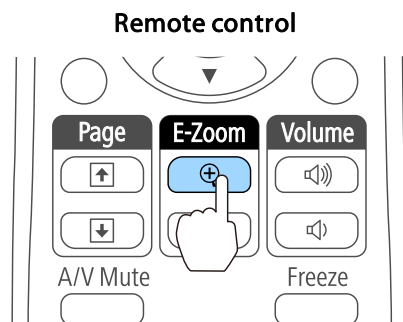

## 2 Move the Cross (⊕) to the area of the image that you want to enlarge.

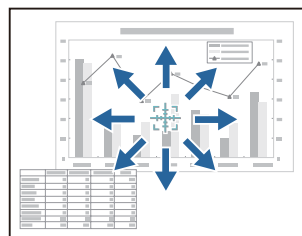
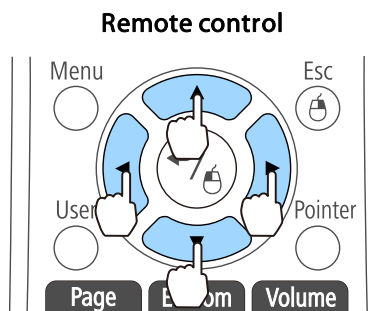

When any pair of adjacent [⬆], [⬇], [⬅], or [➡] buttons are pressed at the same time, the pointer can be moved diagonally.

## 3 Enlarge.

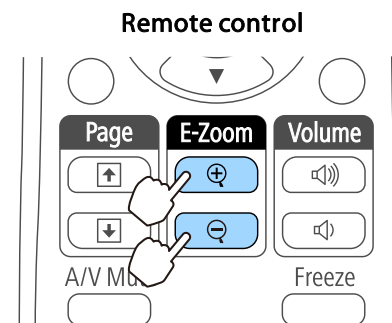

[⊕] button: Expands the area each time it is pressed. You can expand quickly by holding the button down.

[⊖] button: Reduces images that have been enlarged.

[Esc] button: Cancels E-Zoom.



- The enlargement ratio appears on the screen. The selected area can be enlarged to between 1 to 4 times in 25 incremental steps.
- During enlarged projection, press the [⬆], [⬇], [⬅], and [➡] buttons to scroll the image.

## Using the Remote Control to Operate the Mouse Pointer (Wireless Mouse)

You can control the computer's mouse pointer from the projector's remote control. This function is called Wireless Mouse.

The following operating systems are compatible with Wireless Mouse.

	Windows	OS X
OS	Windows 2000	Mac OS X 10.3.x
	Windows XP	Mac OS X 10.4.x
	Windows Vista	Mac OS X 10.5.x
	Windows 7	Mac OS X 10.6.x
	Windows 8	OS X 10.7.x
	Windows 8.1	OS X 10.8.x
		OS X 10.9.x

\* It may not be possible to use the Wireless Mouse function under some versions of the operating systems.





Use the following procedure to enable the Wireless Mouse function.

- 1** Set **USB Type B** to **Wireless Mouse/USB Display** from the Configuration menu (EB-585Wi/EB-575Wi only).
  - ☛ **Extended - USB Type B** [p.123](#)
- 2** Connect the projector to the computer with the supplied or a commercially available USB cable.
  - ☛ "Connecting a Computer" [p.28](#)
- 3** Change the source to one of the following.
  - USB Display
  - Computer1
  - Computer2
  - HDMI1
  - HDMI2
  - ☛ "Switching to the Target Image Using the Remote Control" [p.46](#)

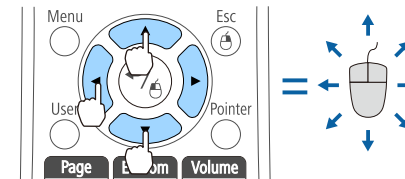
Once set, the mouse pointer can be controlled as follows.

### Moving the mouse pointer



[][][][] buttons:  
Moves the mouse pointer.



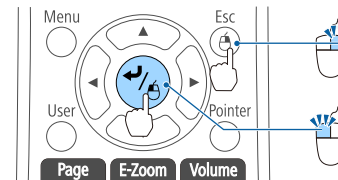

### Mouse clicks

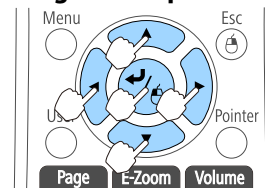

[Esc] button: Right click.  
[Enter] button: Left click. Press quickly twice to double-click.



### Drag and drop

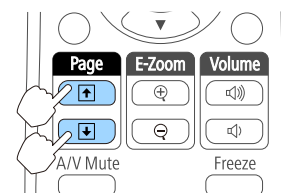

While holding down the [Enter] button, press the [], [], [], or [] button to drag.  
Release the [Enter] button to drop at the desired location.

### Page Up/Down



[] button: Moves to the previous page.  
[] button: Moves to the next page.





- When any pair of adjacent [↖], [↘], [↙], or [↗] buttons are pressed at the same time, the pointer can be moved diagonally.
- If the mouse button settings are set to reverse on the computer, the operation of the remote control buttons will also be reversed.
- The Wireless Mouse function does not work under the following conditions.
  - When **Extended - USB Type B** is set to anything other than **Wireless Mouse/USB Display** (EB-585Wi/EB-575Wi only).
  - When projecting images from a device connected to the HDMI1/MHL ports using an MHL cable.
  - When displaying the Configuration menu or help.
  - When operating functions other than the Wireless Mouse function (such as adjusting the volume).
 However, when using the E-Zoom or Pointer function, the page up or down function is available.

## Saving a User's Logo

You can save the image that is currently being projected as a User's Logo. You can use the registered user's logo as a display when projection starts or no image signal is being input.

☛ **Extended - Display** p.123



- Once a User's Logo has been saved, the logo cannot be returned to the factory default.
- If the content of the Configuration menu is set from another projector using the batch setup function, the registered User's Logo is set for the other projectors. Do not register confidential information and so on as the User's Logo.
  - ☛ "Performing Batch Setup for Multiple Projectors" p.138

**1** Project the image you want to save as the User's Logo, and then press the [Menu] button.

☛ "Using the Configuration Menu" p.116

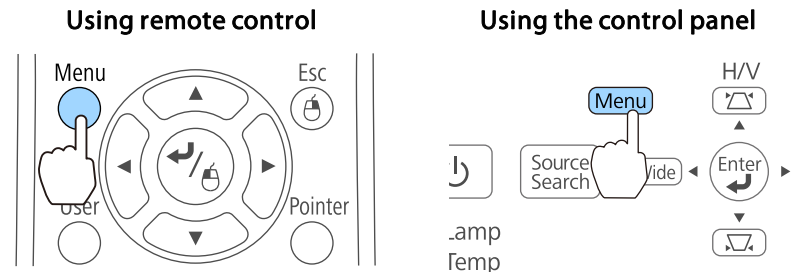

**2** Select **User's Logo** from **Extended**.

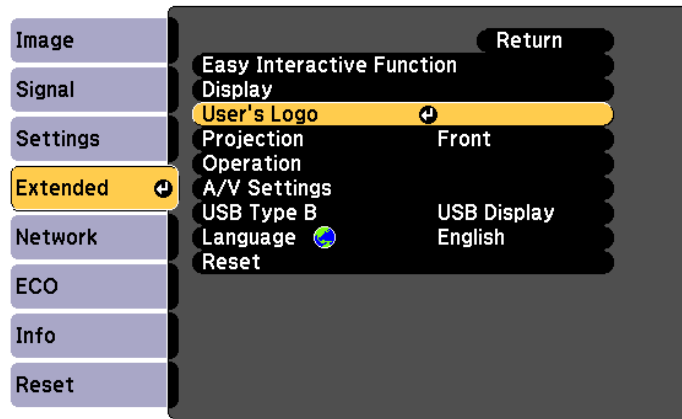

- When **User's Logo Protection** from **Password Protection** is set to **On**, a message is displayed and the User's Logo cannot be changed. You can make changes after setting **User's Logo Protection** to **Off**.
  - "Managing Users (Password Protection)" [p.101](#)
- If **User's Logo** is selected when Keystone, E-Zoom, Aspect, or Adjust Zoom is being performed, the function currently being performed is cancelled.

**3** When the message "Choose this image as the User's Logo?" is displayed, select **Yes**.



When you press the [Enter] button on the remote control or the control panel, the screen size may change depending on the signal to match the actual resolution of the image signal.

**4** Move the box to select the part of the image to use as the User's Logo.

You can perform the same operations from the projector's control panel.

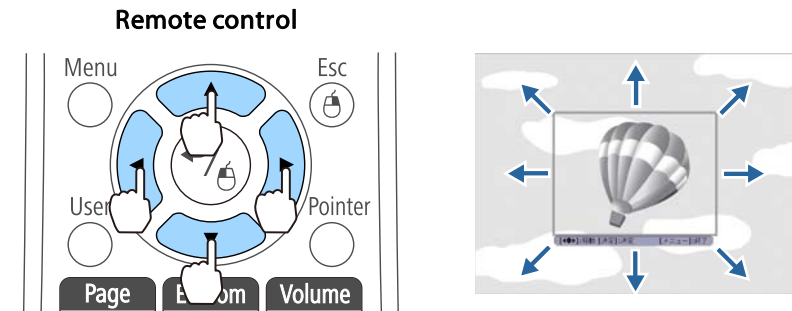

You can save at 400x300 dots in size.

**5** When you press the [Enter] button and the message "Select this image?" is displayed, select **Yes**.

- 6** Select the zoom factor from the zoom setting screen.

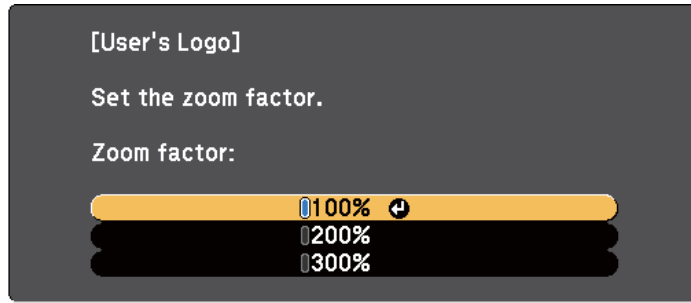

- 7** When the message "Save this image as the User's Logo?" is displayed, select **Yes**.

The image is saved. After the image has been saved, the message "Completed." is displayed.



When a User's Logo is saved, the previous User's Logo is erased.

## Saving User Pattern

There are four types of patterns registered to the projector, such as ruled lines and grid patterns.

☛ **Settings - Pattern - Pattern Type** p.122

You can also save the image that is currently being projected as a User Pattern.



When a User Pattern is saved, the previous User Pattern is erased.

- 1** Project the image you want to use as the User Pattern, and then press the [Menu] button.

☛ "Using the Configuration Menu" p.116

### Using Remote Control

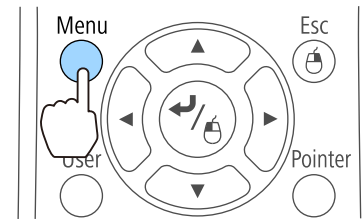

### Using the Control Panel

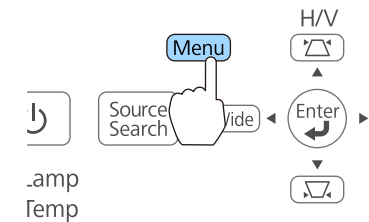

- 2** Select **Pattern** from **Settings**.

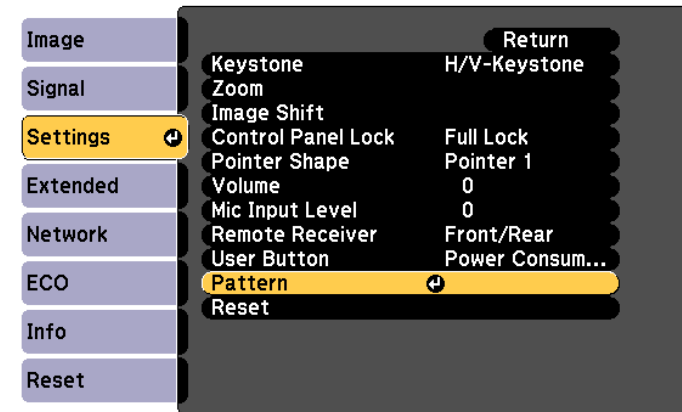

- 3** Select **User Pattern**.

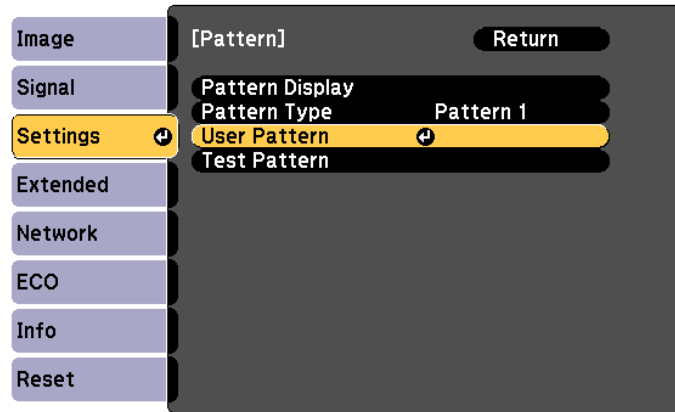

If **User Pattern** is selected when Keystone, E-Zoom, Aspect, Adjust Zoom, or Image Shift are being performed, the function currently being performed is temporarily canceled.

**4** When "Do you want to use the currently projected image as the User Pattern?" is displayed, select **Yes**.

**5** When you press the [] button, the message "Do you save this image as the User Pattern?" is displayed. Select **Yes**.

The image is saved. After the image has been saved, the message "The User Pattern setting is complete." is displayed.



Once a User Pattern has been saved, User Pattern cannot be returned to the factory default.

The projector has the following enhanced security functions.

- **Password Protection**  
You can limit who can use the projector.
- **Control Panel Lock**  
You can prevent people changing the settings on the projector without permission.  
☛ "Restricting Operation (Control Panel Lock)" [p.103](#)
- **Anti-Theft Lock**  
The projector is equipped with the following anti-theft security device.  
☛ "Anti-Theft Lock" [p.104](#)

## Managing Users (Password Protection)

When Password Protection is activated, people who do not know the password cannot use the projector to project images even if the projector power is on. Furthermore, the user's logo that is displayed when you turn on the projector cannot be changed. This acts as an anti-theft device as the projector cannot be used even if it is stolen. At the time of purchase, Password Protection is not activated.

### Kinds of Password Protection

The following three kinds of Password Protect settings can be made according to how the projector is being used.

- **Power On Protection**  
When **Power On Protection** is **On**, you need to enter a preset password after the projector is plugged in and turned on (this also applies to Direct Power On). When the correct password is entered, projection starts.

- **User's Logo Protection**

Even if someone tries to change the User's Logo set by the owner of the projector, it cannot be changed. When **User's Logo Protection** is set to **On**, the following setting changes for the User's Logo are prohibited.

- Capturing a User's Logo
- Setting **Display Background**, **Startup Screen**, or **A/V Mute** from **Display**  
☛ **Extended - Display** [p.123](#)

- **Network Protection**

When **Network Protection** is set to **On**, changing the settings for **Network** is prohibited.

- ☛ "Network Menu" [p.127](#)

## Setting Password Protection

Use the following procedure to set Password Protect.

- 1** During projection, hold down the [Freeze] button for about five seconds.

The Password Protection setting menu is displayed.

### Remote control

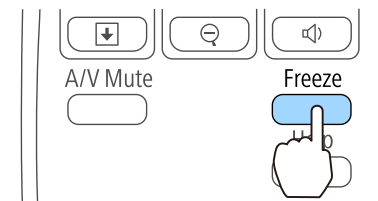



- If Password Protection is already activated, you must enter the password.  
If the password is entered correctly, the Password Protection setting menu is displayed.
- "Entering the Password" p.102
- When the password is set, stick the supplied password protect sticker in a visible position on the projector as a further theft deterrent.

- 2 Select the type of Password Protect you want to set, and then press the [Enter] button.

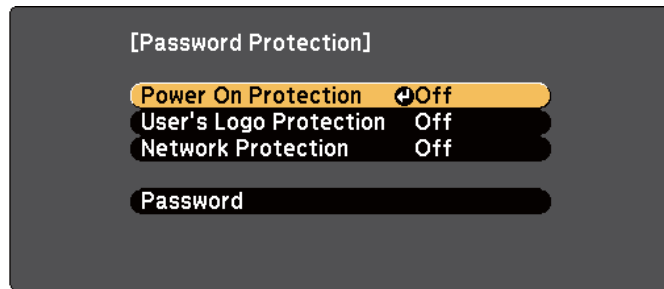

- 3 Select **On**, and then press the [Enter] button.  
Press the [Esc] button, the screen displayed in step 2 is displayed again.

- 4 Set the password.
  - (1) Select **Password**, and then press the [Enter] button.
  - (2) When the message "Change the password?" is displayed, select **Yes** and then press the [Enter] button. The default password is set to "0000". Change this to your own desired Password. If you select **No**, the screen displayed in step 2 is displayed again.
  - (3) While holding down the [Num] button, enter a four digit number using the numeric buttons. The number entered is displayed as "\* \* \* \*". When you enter the fourth digit, the confirmation screen is displayed.

Remote control

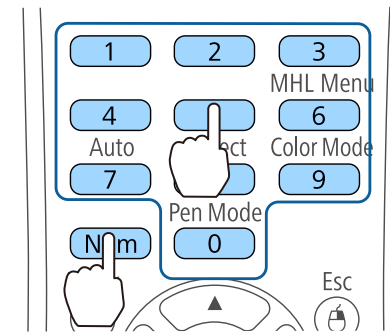

- (4) Re-enter the password.  
The message "Password accepted." is displayed.  
If you enter the password incorrectly, a message is displayed prompting you to re-enter the password.

## Entering the Password

When the password entry screen is displayed, enter the password using the remote control.

While holding down the [Num] button, enter the password by pressing the numeric buttons.

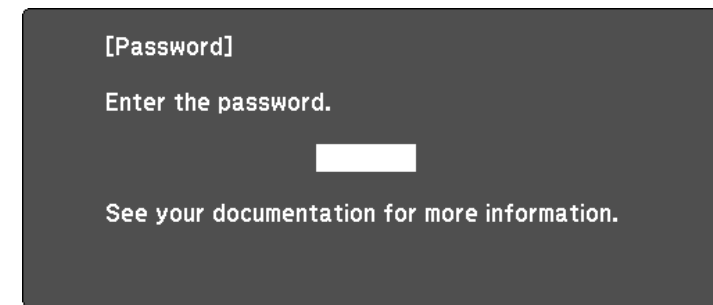

When you enter the correct password, Password Protect is temporarily released.

## Attention

- If an incorrect password is entered three times in succession, the message "The projector's operation will be locked." is displayed for approximately five minutes, and then the projector switches to standby mode. If this happens, disconnect the power plug from the electrical outlet and then reinsert it and turn the projector's power back on. The projector displays the password entry screen again so that you can enter the correct password.
- If you have forgotten the password, make a note of the "Request Code: xxxxx" number that appears on the screen and contact the nearest address provided in the Epson Projector Contact List.  
[Epson Projector Contact List](#)
- If you continue to repeat the above operation and input the wrong Password 30 times in succession, the following message is displayed and the projector does not accept any more Password entries. "The projector's operation will be locked. Contact Epson as described in your documentation."  
[Epson Projector Contact List](#)

## Restricting Operation (Control Panel Lock)

Do one of the following to lock the operation buttons on the control panel.

- **Full Lock**  
All of the buttons on the control panel are locked. You cannot perform any operations from the control panel, including turning the power on or off.
- **Partial Lock**  
All of the buttons on the control panel, except for the [⏻] power button, are locked.

This is useful at events or shows when you want to deactivate all buttons during projection or at schools when you want to limit button operation. The projector can still be operated using the remote control.

- 1 Press the [Menu] button while projecting.  
 "Using the Configuration Menu" [p.116](#)

### Using Remote Control

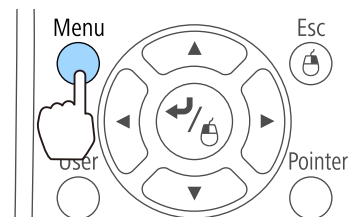

### Using the Control Panel

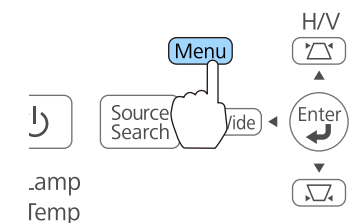

- 2 Select **Control Panel Lock** from **Settings**.

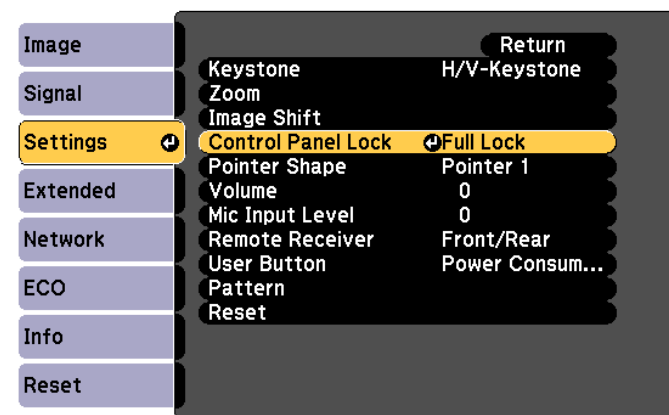

- 3 Select either **Full Lock** or **Partial Lock** according to your purpose.

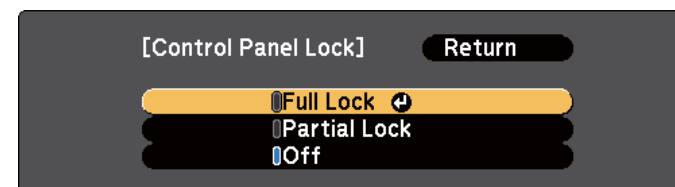

- 4** Select **Yes** when the confirmation message is displayed.  
The control panel buttons are locked according to the setting you chose.



You can release the control panel lock by one of the following two methods.

- Select **Off** from **Control Panel Lock**.
  - ☛ **Settings - Control Panel Lock** p.122
- Press and hold down the [Enter] button on the control panel for about seven seconds, a message is displayed and the lock is released.

## Anti-Theft Lock

The projector is equipped with the following types of anti-theft security devices.

- **Security slot**  
The security slot is compatible with the Microsaver Security System manufactured by Kensington.  
See the following for more details on the Microsaver Security System.  
☛ <http://www.kensington.com/>
- **Security cable installation point**  
A commercially available theft-prevention wire lock can be passed through the installation point to secure the projector to a desk or pillar.  
Do not pass drop-prevention wires through here when mounting the projector on a wall or suspending it from a ceiling.

### Installing the Wire Lock

Pass an anti-theft wire lock through the installation point.

See the documentation supplied with the wire lock for locking instructions.

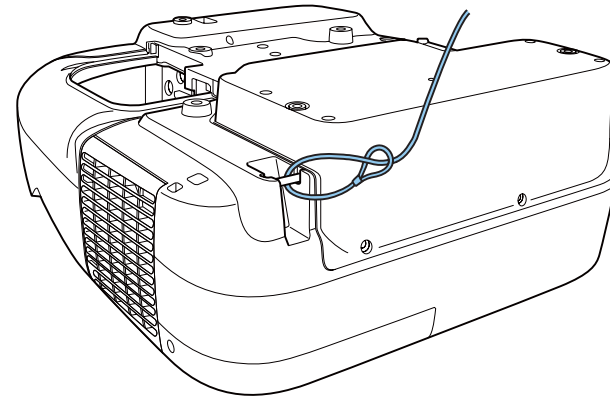



## About EasyMP Monitor

EasyMP Monitor lets you carry out operations such as checking the status of multiple Epson projectors that are connected to a network at a computer monitor, and controlling the projectors from the computer.

You can download EasyMP Monitor from the following Web site.

<http://www.epson.com>

The following provides descriptions of the monitoring and control functions that can be carried out using EasyMP Monitor.

- Registering projectors for monitoring and control
- Group registration for registered projectors
- Monitoring the status of registered projectors
- Controlling registered projectors
- Mail Notification settings
- Sending messages to registered projectors

## Message Broadcasting

Message Broadcasting is plugin software for EasyMP Monitor. Message Broadcasting can be used to send a message (JPEG file) to project on all Epson projectors or specified projectors connected on the network.

The data can be sent manually, or sent automatically using Timer Settings of EasyMP Monitor.

Download the Message Broadcasting software from the following Web site.

<http://www.epson.com>

## Changing Settings Using a Web Browser (Web Control)

By using the Web browser of a computer connected to the projector on a network, you can set the projector's functions and control the projector.

This function allows you to perform setup and control operations remotely. In addition, since you can use the computer's keyboard, entering characters required for the setup is easier.

Use Microsoft Internet Explorer 8.0 or later as the Web browser. Use Safari for OS X.



If you set **Standby Mode** to **Communication On**, you can use a Web browser to make settings and perform control even if the projector is in standby mode (when the power is off).

☛ **ECO - Standby Mode** p.135

## Projector Setup

In a Web browser, you can set items that are usually set in the projector's Configuration menu. The settings are reflected in the Configuration menu. There are also items that can only be set in a Web browser.

Items in the Configuration Menu that Cannot Be Set by a Web Browser

- Settings menu - Image Shift
- Settings menu - Pointer Shape
- Settings menu - Pattern (except Pattern Type)
- Settings menu - User Button
- Extended menu - User's Logo
- Extended menu - USB Type B
- Extended menu - Easy Interactive Function
- Extended menu - Language
- Extended menu - Operation - High Altitude Mode
- Reset menu - Reset All and Reset Lamp Hours

The settings for items on each menu are the same as the projector's Configuration menu.

☛ "Configuration Menu" p.115

## Items that Can only Be Set with a Web Browser

- SNMP Community Name (up to 32 single-byte alphanumeric characters)
- Monitor Password (up to 16 single-byte alphanumeric characters)

## Displaying the Web Control Screen

Use the following procedure to display the Web Control screen.

Make sure the computer and projector are connected to the network. Use Advanced when connecting via a Wireless LAN.



If your Web browser is set up to connect via a proxy server, the Web Control screen cannot be displayed. To display Web Control, you need to make settings so that a proxy server is not used for a connection.

- 1** Start a Web browser on the computer.
- 2** Enter the IP address of the projector in the address input box of the Web browser, and press the Enter key on the computer's keyboard.

The Web Control screen is displayed.

When **Web Control Password** is set from the Configuration menu, the password entry screen is displayed.

- 3** Enter the User ID and Password, and then press the Enter key on your computer's keyboard.

The User ID is "EPSONWEB".

The default password is "admin".

When the correct user ID and password are entered, the Web control screen is displayed.



- Enter the user ID even if the password setting is disabled. The user ID cannot be changed.
- You can change the password in Network menu from the Configuration menu.  
☛ **Network - Basic - Web Control Password p.127**

## Displaying the Web Remote Screen

The Web Remote function allows you to perform projector remote control operations with a Web browser.

- 1** Display the Web Control screen.
- 2** Click **Web Remote**.



- 3** The Web Remote screen is displayed.

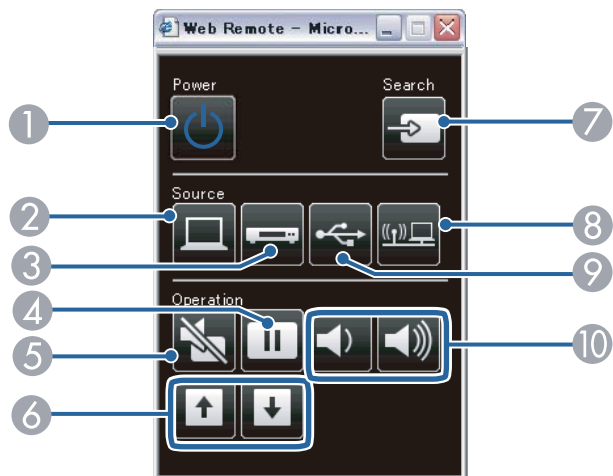

Name	Function
1 [Power] button [⏻]	Turns the projector power on or off. ☛ "Getting Ready to Project" p.44
2 [Computer] button	Each time the button is pressed, it cycles through the following images: <ul style="list-style-type: none"> <li>• Computer1 port</li> <li>• Computer2 port</li> </ul>
3 [Video] button	Each time the button is pressed, it cycles through the following images: <ul style="list-style-type: none"> <li>• S-Video port</li> <li>• Video port</li> <li>• HDMI1/MHL port</li> <li>• HDMI2 port</li> </ul>
4 [Freeze] button	Pauses or resumes image playback. ☛ "Freezing the Image (Freeze)" p.93
5 [A/V Mute] button	Turns the video and audio on or off. ☛ "Hiding the Image and Sound Temporarily (A/V Mute)" p.93

Name	Function
6 [Page] buttons [Up] [Down]	Changes pages in files such as PowerPoint files when using the following projection methods. <ul style="list-style-type: none"> <li>• When using the Wireless Mouse function                             <ul style="list-style-type: none"> <li>☛ "Using the Remote Control to Operate the Mouse Pointer (Wireless Mouse)" p.95</li> </ul> </li> <li>• When using USB Display                             <ul style="list-style-type: none"> <li>☛ "Projecting with USB Display" p.47</li> </ul> </li> <li>• When connecting to a network</li> </ul> When projecting images using PC Free, pressing these buttons displays the previous/next image file.
7 [Source Search] button	Switches to the image from the input port where video signals are being input. ☛ "Automatically Detect Input Signals and Change the Projected Image (Source Search)" p.45
8 [LAN] button	Switches to the image from the network connected device. ☛ "Switching to the Target Image Using the Remote Control" p.46
9 [USB] button	Each time the button is pressed, it cycles through the following images: <ul style="list-style-type: none"> <li>• USB Display</li> <li>• Images from the device connected to the USB-A port</li> </ul> ☛ "Switching to the Target Image Using the Remote Control" p.46
10 [Volume] buttons [⏮] [⏭]	[⏮] Decreases the volume. [⏭] Increases the volume. ☛ "Adjusting the Volume" p.57

## Using the Mail Notification Function to Report Problems

When you set Mail Notification, notification messages are sent to the preset email addresses when a problem or warning occurs with a projector. This

will enable the operator to be notified of problems with projectors even at locations away from the projectors.

## ☛ Network - Mail - Mail Notification [p.133](#)



- Up to three notification destinations (addresses) can be registered, and notification messages can be sent to all three destinations at once.
  - If a projector develops a critical problem and suddenly stops working, it may not be able to send a message notifying an operator of the problem.
  - Controlling is possible if **Standby Mode** is set to **Communication On**, even if the projector is in standby state (when the power is off).
- ☛ **ECO - Standby Mode** [p.135](#)

## Reading Error Notification Mail

When the Mail Notification function is set to On and a problem or warning occurs in the projector, the following email will be sent.

Sender: Email Address 1

Email title: EPSON Projector

Line 1: The name of the projector where the problem occurred

Line 2: The IP address set for the projector where the problem has occurred

Line 3 and on: Details of the problem

The details of the problem are listed line by line. The main message contents are listed below.

- Internal error
- Fan related error
- Sensor error

- Lamp timer failure
- Lamp out
- Internal temperature error
- High-speed cooling in progress
- Lamp replacement notification
- No-signal  
No Signal is input to the projector. Check the connection status or check that the power for the signal source is turned on.
- Auto Iris Error
- Power Err. (Ballast)
- Obstacle Detection Error

See the following to deal with problems or warnings.

## ☛ "Reading the Indicators" [p.141](#)

---

## Management Using SNMP

By setting **SNMP** to **On** in the Configuration menu, notification messages are sent to the specified computer when a problem or warning occurs. This will enable the operator to be notified of problems with projectors even at locations away from the projectors.

## ☛ Network - Others - SNMP [p.134](#)



- SNMP should be managed by a network administrator or someone who is familiar with the network.
- To use the SNMP function to monitor the projector, you need to install the SNMP manager program on your computer.
- The SNMP Agent for this projector complies with version 1 (SNMPv1).
- The managing function using SNMP cannot be used via wireless LAN in Quick connection mode.
- Up to two destination IP addresses can be saved.

## ESC/VP21 Commands

You can control the projector from an external device using ESC/VP21.

### Command List

When the power ON command is transmitted to the projector, the power turns on and it enters warm-up mode. When the projector's power has turned on, a colon ":" (3Ah) is returned.

When a command is input, the projector executes the command and returns a ":", and then accepts the next command.

If the command being processed terminates abnormally, an error message is output and a ":" is returned.

The main contents are listed below.

Item		Command	
Power ON/OFF	On	PWR ON	
	Off	PWR OFF	
Signal selection	Computer1	Auto	SOURCE 1F
		RGB	SOURCE 11
		Component	SOURCE 14

Item		Command
Computer2	Auto	SOURCE 2F
	RGB	SOURCE 21
	Component	SOURCE 24
HDMI1/MHL		SOURCE 30
HDMI2		SOURCE A0
Video		SOURCE 41
S-Video		SOURCE 42
USB Display		SOURCE 51
USB		SOURCE 52
LAN		SOURCE 53
A/V Mute ON/OFF	On	MUTE ON
	Off	MUTE OFF

Add a Carriage Return (CR) code (0Dh) to the end of each command and transmit.

For more details, contact your local dealer or the nearest address provided in the Epson Projector Contact List.

 [Epson Projector Contact List](#)

### Cable Layouts

#### Serial Connection

- Connector shape: D-Sub 9-pin (male)

- Projector input port name: RS-232C

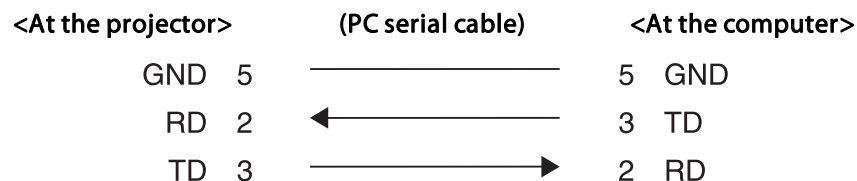
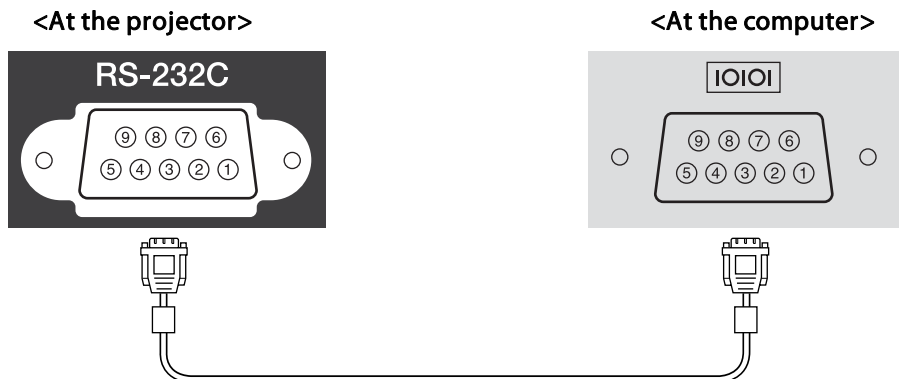

Signal Name	Function
GND	Signal wire ground
TD	Transmit data
RD	Receive data

## Communications Protocol

- Default baud rate setting: 9600 bps
- Data length: 8 bit
- Parity: None
- Stop-bit: 1 bit
- Flow control: None

## About PJLink

PJLink Class1 was established by the JBMIA (Japan Business Machine and Information System Industries Association) as a standard protocol for controlling network-compatible projector's as part of their efforts to standardize projector control protocols.

The projector complies with the PJLink Class1 standard established by the JBMIA.

You need to make network settings before you can use PJLink. See the following for more information on network settings.

☛ "Network Menu" [p.127](#)

It complies with all commands except for the following commands defined by PJLink Class1, and agreement was confirmed by the PJLink standard adaptability verification.

URL:<http://pjlink.jbmia.or.jp/english/>

- **Non-compatible commands**

Function		PJLink Command
Mute settings	Image muting set	AVMT 11
	Audio muting set	AVMT 21

- **Input names defined by PJLink and corresponding projector sources**

Source	PJLink Command
Computer1	INPT 11
Computer2	INPT 12
Video	INPT 21
S-Video	INPT 22
HDMI1/MHL	INPT 32
HDMI2	INPT 33

Source	PJLink Command
USB	INPT 41
LAN	INPT 52
USB Display	INPT 53

- Manufacturer name displayed for "Manufacture name information query"  
EPSON
- Model name displayed for "Product name information query"  
EPSON 585  
EPSON 580  
EPSON 575  
EPSON 570

## About Crestron RoomView®

Crestron RoomView® is an integrated control system provided by Crestron®. It can be used to monitor and control multiple devices connected on a network.

The projector supports the control protocol, and can therefore be used in a system built with Crestron RoomView®.

Visit the Crestron® Web site for details on Crestron RoomView®. (Only English-language displays are supported.)

<http://www.crestron.com>

The following provides an overview of Crestron RoomView®.

### • Remote operation using a Web browser

You can operate a projector from your computer just like using a remote control.

### • Monitoring and control with application software

You can use Crestron RoomView® Express or Crestron RoomView® Server Edition provided by Crestron® to monitor devices in the system, to communicate with the help desk, and to send emergency messages. See the following Web site for details.

<http://www.crestron.com/getroomview>

This manual describes how to perform operations on your computer using a Web browser.



- You can only enter single-byte alphanumeric characters and symbols.
- The following functions cannot be used while using Crestron RoomView®.
  - ☛ "Changing Settings Using a Web Browser (Web Control)" p.105
  - Message Broadcasting (EasyMP Monitor plug-in)
- Controlling is possible if **Standby Mode** is set to **Communication On**, even if the projector is in standby state (when the power is off).
  - ☛ ECO - Standby Mode p.135

## Operating a Projector from Your Computer

### Displaying the Operation Window

Check the following before carrying out any operations.

- Make sure the computer and projector are connected to the network. When communicating with a wireless LAN, connect in Advanced connection mode.
  - ☛ "Wireless LAN Menu" p.130
- Set **Crestron RoomView** to **On** from the **Network** menu.
  - ☛ **Network - Others - Crestron RoomView** p.134

- 1 Start a Web browser on the computer.
- 2 Enter the IP address of the projector in the address field of the Web browser, and press the Enter key on the keyboard.  
The operation window is displayed.

Using the Operation Window



- 1 You can perform the following operations when you click the buttons.

Button	Function
<b>Power</b>	Turns the projector power on or off.
<b>Vol-/Vol+</b>	Adjusts the volume.

Button	Function
<b>A/V Mute</b>	Turns the video and audio on or off. ☛ "Hiding the Image and Sound Temporarily (A/V Mute)" p.93

- 2 Switch to the image from the selected input source. To display input sources that are not shown on the screen, click (a) or (b) to scroll up or down. The current video signal input source is displayed in blue.  
You can change the source name if necessary.
- 3 You can perform the following operations when you click the buttons. To display buttons that are not shown on the screen, click (c) or (d) to scroll left or right.

Button	Function
<b>Freeze</b>	Pauses or resumes image playback. ☛ "Freezing the Image (Freeze)" p.93
<b>Contrast</b>	You can adjust the difference between light and dark in the images.
<b>Brightness</b>	You can adjust the image brightness.
<b>Color</b>	You can adjust the color saturation for the images.
<b>Sharpness</b>	You can adjust the image sharpness.
<b>Zoom</b>	Click the [⊕] button to enlarge the image without changing the projection size. Click the [⊖] button to reduce an image that was enlarged with the [⊕] button. Click the [▲], [▼], [◀], or [▶] buttons to change the position of an enlarged image. ☛ "Enlarging Part of the Image (E-Zoom)" p.94

- 4 The [▲], [▼], [◀], and [▶] buttons perform the same operations as the [⊕], [⊖], [◀], and [▶] buttons on the remote control. You can perform the following operations when you click the other buttons.



Button	Function
<b>OK</b>	Performs the same operation as the [Enter] button on the remote control. ☛ "Remote Control" p.17
<b>Menu</b>	Displays and closes the Configuration menu.
<b>Auto</b>	If clicked while projecting analog RGB signals from Computer1 port or Computer2 port, automatically optimizes the image by adjusting the Tracking, Sync., and Position.
<b>Search</b>	Switches to the image from the input port where video signals are being input. ☛ "Automatically Detect Input Signals and Change the Projected Image (Source Search)" p.45
<b>Esc</b>	Performs the same operation as the [Esc] button on the remote control. ☛ "Remote Control" p.17

5 You can perform the following operations when you click the tabs.

Tab	Function
<b>Contact IT Help</b>	Displays the Help Desk window. Used to send messages to, and receive messages from, the administrator using Crestron RoomView® Express.
<b>Info</b>	Displays information on the projector that is currently connected.
<b>Tools</b>	Changes settings in the projector that is currently connected. See the next section.

### Using the Tools Window

The following window is displayed when you click the **Tools** tab on the operation window. You can use this window to change settings in the projector that is currently connected.

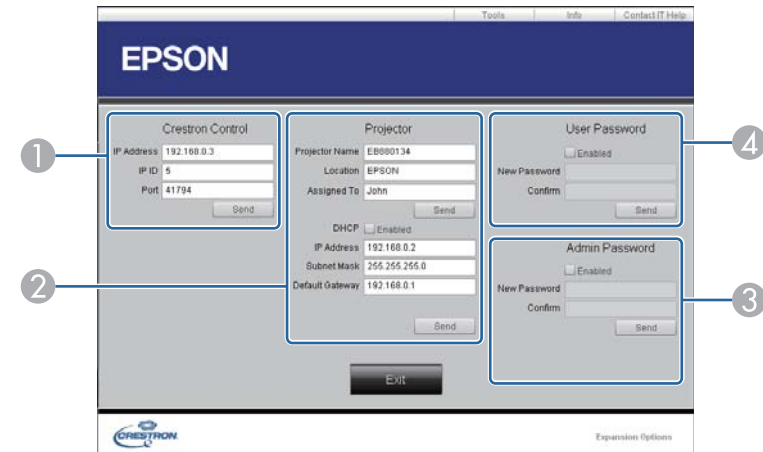

- 1 **Crestron Control**  
Make settings for Crestron® central controllers.
- 2 **Projector**  
The following items can be set.

Item	Function
<b>Projector Name</b>	Enter a name to differentiate the projector that is currently connected from other projectors on the network. (The name can contain up to 15 single-byte alphanumeric characters.)
<b>Location</b>	Enter an installation location name for the projector that is currently connected on the network. (The name can contain up to 32 single-byte alphanumeric characters and symbols.)
<b>Assigned To</b>	Enter a user name for the projector. (The name can contain up to 32 single-byte alphanumeric characters and symbols.)

Item	Function
<b>DHCP</b>	Select the <b>Enabled</b> check box to use DHCP. You cannot enter an IP address if DHCP is enabled.
<b>IP Address</b>	Enter the IP address to assign to the currently connected projector.
<b>Subnet Mask</b>	Enter a subnet mask for the currently connected projector.
<b>Default Gateway</b>	Enter the gateway address for the currently connected projector.
<b>Send</b>	Click this button to confirm the changes made to the <b>Projector</b> .

### 3 Admin Password

Select the **Enabled** check box to require a password to open the Tools window. The following items can be set.

Item	Function
<b>New Password</b>	Enter the new password when changing the password to open the Tools window. (The name can contain up to 26 single-byte alphanumeric characters.)
<b>Confirm</b>	Enter the same password as you entered in <b>New Password</b> . If the passwords are not the same, an error is displayed.
<b>Send</b>	Click this button to confirm the changes made to the <b>Admin Password</b> .

### 4 User Password

Select the **Enabled** check box to require a password to open the operation window on the computer. The following items can be set.

Item	Function
<b>New Password</b>	Enter the new password when changing the password to open the operation window. (Up to 26 single-byte alphanumeric characters)
<b>Confirm</b>	Enter the same password as you entered in <b>New Password</b> . If the passwords are not the same, an error is displayed.
<b>Send</b>	Click this button to confirm the changes made to the <b>User Password</b> .



# Configuration Menu

This chapter explains how to use the Configuration menu and its functions.

This section explains how to use the Configuration menu.

Although steps are explained using the remote control as an example, you can perform the same operations from the control panel. Check the guide under the menu for the available buttons and their operations.

## 1 Display the Configuration menu screen.

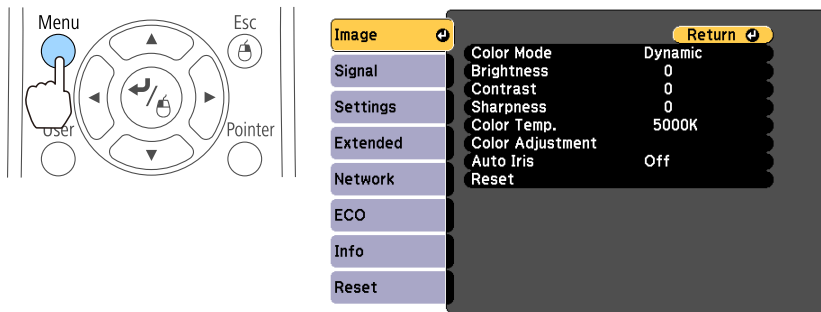

## 2 Select a top menu item.

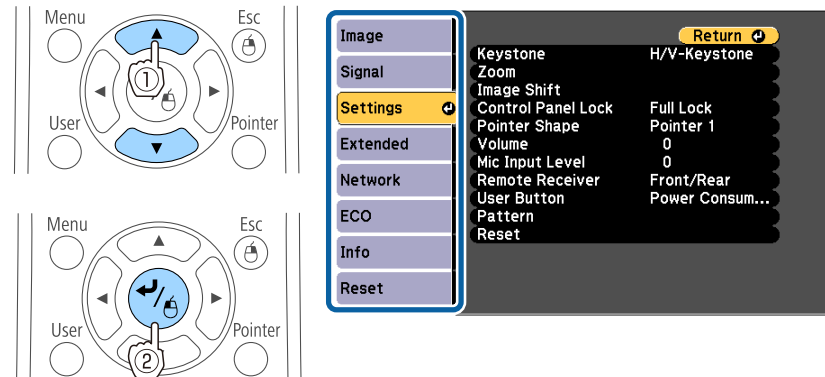

## 3 Select a submenu item.

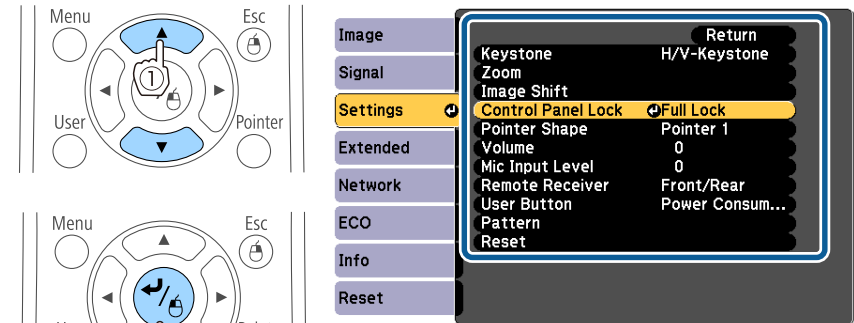

## 4 Change settings.

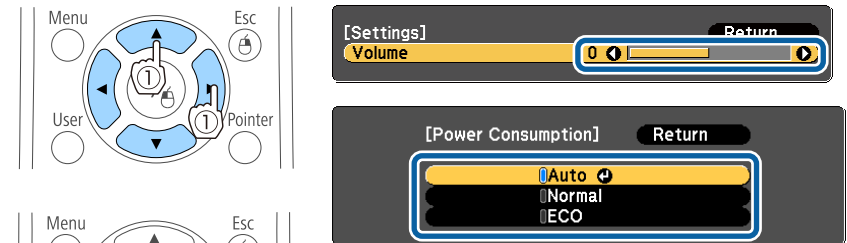

## 5 Press the [Menu] button to finish making settings.

## Configuration Menu Table

Settable items vary depending on the model being used and the image signal and source being projected.

Top Menu Name	Submenu Name	Items or Setting Values
Image menu ☛ p.119	Color Mode	Dynamic, Presentation, Theatre, Photo, Sports, sRGB, Blackboard, and Whiteboard
	Brightness	-24 to 24
	Contrast	-24 to 24
	Color Saturation	-32 to 32
	Tint	-32 to 32
	Sharpness	-5 to 5
	Color Temp.	5000K to 10000K, -3 to 6
	Color Adjustment	Red: -16 to 16 Green: -16 to 16 Blue: -16 to 16
Auto Iris	Off, Normal, and High Speed	
Signal menu ☛ p.120	Auto Setup	On and Off
	Resolution	Auto, Wide, and Normal
	Tracking	-
	Sync.	-
	Position	Up, Down, Left, and Right
	Progressive	Off, Video, and Film/Auto
	Noise Reduction	Off, NR1, and NR2
	HDMI Video Range	Auto, Normal, and Expanded
Input Signal	Auto, RGB, and Component	

Top Menu Name	Submenu Name	Items or Setting Values
	Video Signal	Auto, NTSC, NTSC4.43, PAL, M-PAL, N-PAL, PAL60, and SECAM
	Aspect	Normal, Auto, 4:3, 16:9, Full, Zoom, and Native
	Overscan	Auto, Off, 4%, and 8%
	Image Processing	Fine, Fast
Settings menu ☛ p.122	Keystone	H/V-Keystone and Quick Corner
	Zoom	0 (Wide) to 40 (Tele)
	Image Shift	-
	Control Panel Lock	Full Lock, Partial Lock, and Off
	Pointer Shape	Pointer 1, Pointer 2, Pointer 3
	Volume	0 to 20
	Mic Input Level	0 to 5
	Remote Receiver	Front/Rear, Front, Rear and Off
	User Button	Power Consumption, Info, Progressive, Test Pattern, Resolution, Mic Input Level, Pattern Display, Auto Calibration
	Pattern	Pattern Display, Pattern Type, User Pattern, and Test Pattern
Extended menu ☛ p.123	Easy Interactive Function	Items in <b>General</b> Auto Calibration, Manual Calibration, Pen Mode, Hovering, Advanced Items in <b>PC Interactive</b> Pen Operation Mode, Enable Right Click, Advanced

Top Menu Name	Submenu Name	Items or Setting Values
	Display	Messages, Display Background, Startup Screen, A/V Mute, Toolbars, Pen Mode Icon, Projector Control
	User's Logo	-
	Projection	Front, Front/Upside Down, Rear, Rear/Upside Down
	Operation	Direct Power On, High Altitude Mode, Startup Source Search, Monitor Out Port
	A/V Settings	A/V Output, Audio Output, HDMI1 Audio Output, HDMI2 Audio Output
	USB Type B	Easy Interactive Function, USB Display/Easy Interactive Function, Wireless Mouse/USB Display
	Language	15 or 35 languages*
ECO menu ☛ p.135	Power Consumption	Auto, Normal, ECO
	Light Optimizer	On and Off
	Sleep Mode	On and Off
	Sleep Mode Timer	1 to 30
	A/V Mute Timer	On and Off
	Standby Mode	Communication On and Communication Off
	ECO Display	On and Off
Info menu ☛ p.136	Lamp Hours	-
	Source	-
	Input Signal	-
	Resolution	-

Top Menu Name	Submenu Name	Items or Setting Values
	Video Signal	-
	Refresh Rate	-
	Sync Info	-
	Status	-
	Serial Number	-
	Version	-
	Event ID	-
Reset menu ☛ p.137	Reset All	-
	Reset Lamp Hours	-

\* The number of supported languages differs depending on the region where the projector is used.

### Network Menu

Top Menu Name	Submenu Name	Items or Setting Values
Basic menu ☛ p.129	Projector Name	-
	PJLink Password	-
	Web Control Password	-
	Projector Keyword	On and Off
Wireless LAN menu ☛ p.130	Wireless LAN Power	On and Off
	Connection Mode	Quick and Advanced
	Channel	1ch, 6ch, and 11ch
	SSID Auto Setting	On and Off
	SSID	-
	IP Settings	DHCP, IP Address, Subnet Mask, and Gateway Address
	SSID Display	On and Off

Top Menu Name	Submenu Name	Items or Setting Values
	IP Address Display	On and Off
Security menu ☛ p.131	Security	Off, WPA2-PSK, and WPA/WPA2-PSK
	Passphrase	-
Wired LAN menu ☛ p.132	IP Settings	DHCP, IP Address, Subnet Mask, and Gateway Address
	IP Address Display	On and Off
Mail menu ☛ p.133	Mail Notification	On and Off
	SMTP Server	-
	Port Number	-
	Address 1 Setting, Address 2 Setting, and Address 3 Setting	-
Others menu ☛ p.134	SNMP	On and Off
	Trap IP Address 1 and Trap IP Address 2	-
	Priority Gateway	Wired LAN and Wireless LAN
	AMX Device Discovery	On and Off
	Crestron RoomView	On and Off
	Bonjour	On and Off
	Message Broadcasting	On and Off

## Image Menu

Settable items vary depending on the image signal and source currently being projected. Setting details are saved for each image signal.

☛ "Automatically Detect Input Signals and Change the Projected Image (Source Search)" p.45

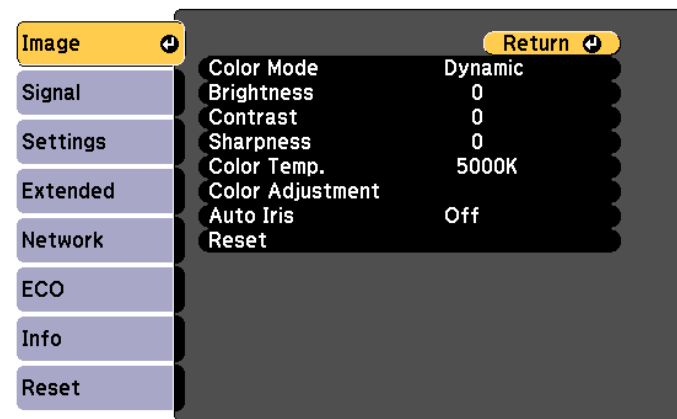

Sub-menu	Function
<b>Color Mode</b>	You can select the quality of the image to suit your surroundings. ☛ "Selecting the Projection Quality (Selecting Color Mode)" p.58
<b>Brightness</b>	You can adjust the image brightness.
<b>Contrast</b>	You can adjust the difference between light and dark in the images.
<b>Color Saturation</b>	(Adjustment is only possible when component video or composite video images are being input.) You can adjust the color saturation for the images.
<b>Tint</b>	(Adjustment is possible when component video signals are being input. Composite video and S-video input signals can only be adjusted when they are NTSC video signals.) You can adjust the image tint.
<b>Sharpness</b>	You can adjust the image sharpness.

Sub-menu	Function
<b>Color Temp.</b>	You can adjust the overall tint of the image. The image is tinted blue when a high value is selected and tinted red when a low value is selected. Values that can be adjusted depend on the <b>Color Mode</b> settings. For <b>sRGB</b> : From 5000K to 10000K in 10 steps For other settings: From -3 to 6 in 10 steps
<b>Color Adjustment</b>	(This item cannot be selected if <b>Color Mode</b> is set to <b>sRGB</b> .) You can adjust the color strength for <b>Red</b> , <b>Green</b> , and <b>Blue</b> individually.
<b>Auto Iris</b>	(This item can be set only if <b>Color Mode</b> is set to <b>Dynamic</b> or <b>Theatre</b> .) Set to <b>Normal</b> or <b>High Speed</b> to adjust the iris to obtain the optimum light for images being projected. Select <b>High Speed</b> to make faster iris corrections to match the speed of the scene. The setting is stored for each Color Mode. ☛ "Setting Auto Iris" <a href="#">p.58</a>
<b>Reset</b>	You can reset all adjustment values for the <b>Image</b> menu to their default settings. See the following to return all menu items to their default settings. ☛ "Reset Menu" <a href="#">p.137</a>

## Signal Menu

Settable items vary depending on the image signal and source currently being projected. Setting details are saved for each image signal.

You cannot make settings on the Signal menu when the source is USB Display, USB, or LAN.

☛ "Automatically Detect Input Signals and Change the Projected Image (Source Search)" [p.45](#)

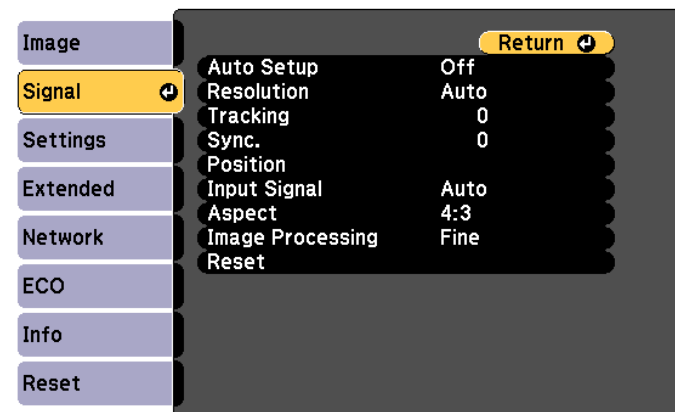

Sub-menu	Function
<b>Auto Setup</b>	(Only available when analog RGB computer signals are being input.) Set to <b>On</b> to automatically adjust Tracking, Sync., and Position to the optimum state when the input signal changes.
<b>Resolution</b>	(Only available when analog RGB computer signals are being input.) Set to <b>Auto</b> to automatically identify the resolution of the input signal. If images are not projected correctly when set to <b>Auto</b> , for example if some of the image is missing, adjust to <b>Wide</b> for wide screens, or set to <b>Normal</b> for 4:3 or 5:4 screens depending on the connected computer.





Sub-menu	Function
<b>Tracking</b>	(Only available when analog RGB computer signals are being input.) You can adjust computer images when vertical stripes appear in the images.
<b>Sync.</b>	(Only available when analog RGB computer signals are being input.) You can adjust computer images when flickering, fuzziness, or interference appear in the images.
<b>Position</b>	(This item cannot be set when the source is HDMI1 or HDMI2.) You can adjust the display position up, down, left, and right when a part of the image is missing so that all of the image is projected.
<b>Progressive</b>	<u>Interlace</u> (i) signal is converted to <u>Progressive</u> (p). (IP conversion) <b>Off:</b> Ideal for images with a large amount of movement. <b>Video:</b> Ideal for general video images. <b>Film/Auto:</b> This is ideal for movie films, computer graphics, and animation.
<b>Noise Reduction</b>	(This item cannot be set when <b>Image Processing</b> is set to <b>Fast</b> .) Smooths out rough images converted using progressive. There are two modes. Select your favorite setting. It is recommended that this is set to <b>Off</b> when viewing image sources in which noise is very low, such as for DVDs.
<b>HDMI Video Range</b>	When the projector's HDMI1 or HDMI2 port is connected to a DVD player, the projector's video range is set according to the DVD player's video range setting. If you are worried about floating black spots or washed out parts in the image, set to <b>Expanded</b> .
<b>Input Signal</b>	You can select the input signal from the Computer1 port or the Computer2 port. If set to <b>Auto</b> , the input signal is set automatically according to the connected equipment. If colors do not appear correctly when set to <b>Auto</b> , select the appropriate signal according to the connected equipment.



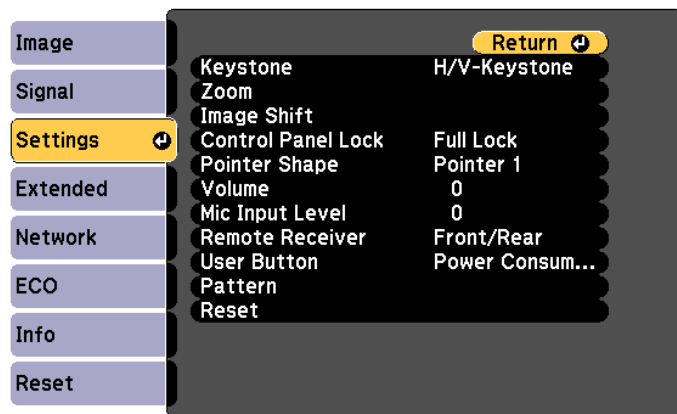



Sub-menu	Function
<b>Video Signal</b>	You can select the input signal from the S-Video port or the Video port. If set to <b>Auto</b> , video signals are recognized automatically. If interference appears in the image or a problem occurs such as no image is being projected when set to <b>Auto</b> , select the appropriate signal according to the connected equipment.
<b>Aspect</b>	You can set the <u>aspect ratio</u> for projected images. ☛ "Changing the Aspect Ratio of the Projected Image" p.59
<b>Overscan</b>	(This setting can only be adjusted when a component video signal is being input.) Changes the output image ratio (the range of the projected image). You can set the cropping range to <b>Off</b> , <b>4%</b> , or <b>8%</b> . You can select <b>Auto</b> when the source is HDMI1 or HDMI2. If you set to <b>Auto</b> , this setting is changed automatically depending on the source.
<b>Image Processing</b>	(This item cannot be selected if <b>Easy Interactive Function</b> is set to <b>PC Interactive</b> ) When <b>Fine</b> is selected, priority is given to image quality, and the image is projected. When <b>Fast</b> is selected, priority is given to processing speed, and the image is projected. This improves the pen's tracking ability when using the interactive features.
<b>Reset</b>	You can reset all adjustment values on the <b>Signal</b> menu to their default settings, except for <b>Input Signal</b> and <b>Image Processing</b> . See the following to return all menu items to their default settings. ☛ "Reset Menu" p.137

## Settings Menu



Sub-menu	Function
<b>Keystone</b>	<p>You can correct keystone distortion.</p> <ul style="list-style-type: none"> <li>When <b>H/V-Keystone</b> is selected: Adjust <b>V-Keystone</b> and <b>H-Keystone</b> to correct horizontal and vertical keystone distortion. ☛ "H/V-Keystone" <a href="#">p.50</a></li> <li>When <b>Quick Corner</b> is selected: Select and correct the four corners of the projected image. ☛ "Quick Corner" <a href="#">p.51</a></li> </ul>
<b>Zoom</b>	Adjusts the projected image size.
<b>Image Shift</b>	<p>You can adjust the position of the image without moving the projector.</p> <p>☛ "Adjusting the Position of the Image (Image Shift)" <a href="#">p.53</a></p>
<b>Control Panel Lock</b>	<p>You can use this to restrict operation of the projector's control panel.</p> <p>☛ "Restricting Operation (Control Panel Lock)" <a href="#">p.103</a></p>



Sub-menu	Function
<b>Pointer Shape</b>	<p>You can select the shape of the pointer.</p> <p>Pointer 1: </p> <p>Pointer 2: </p> <p>Pointer 3: </p> <p>☛ "Pointer Function (Pointer)" <a href="#">p.94</a></p>
<b>Volume</b>	You can adjust the volume. Setting values are saved for each source.
<b>Mic Input Level</b>	<p>Adjusts the volume from the microphone. When <b>Mic Input Level</b> is turned down to 0, no microphone audio is output from the speaker.</p> <p>When the microphone input level is raised, the audio from the connected device becomes quieter. When the microphone input level is lowered, the audio from the connected device becomes louder.</p>
<b>Remote Receiver</b>	<p>You can limit the reception of the operation signal from the remote control.</p> <p>When set to <b>Off</b>, you cannot perform any operations from the remote control. If you want to make operations from the remote control, hold down the [Menu] button on the remote control for at least 15 seconds to reset the setting to its default value.</p>
<b>User Button</b>	<p>You can select the item in the Configuration menu to be assigned to the [User] button on the remote control. By pressing the [User] button the assigned menu item selection/adjustment screen is displayed, allowing you to make one-touch settings/adjustments. You can assign one of the following items to the [User] button.</p> <p><b>Power Consumption, Info, Progressive, Test Pattern, Resolution, Mic Input Level, Pattern Display, Auto Calibration</b> (EB-585Wi/EB-575Wi only)</p>

Sub-menu	Function
<b>Pattern</b>	<p><b>Pattern Display:</b> Display a pattern.</p> <p><b>Pattern Type:</b> You can select from Patterns 1 to 5 or User Pattern. Patterns 1 to 4 display projection lines such as ruled lines or a grid. Pattern 5 displays a test pattern for 4:3 screens. When displaying a test pattern on a 4:3 screen using a wide-screen projector to adjust the focus, select <b>Pattern 5</b>.</p> <p>Pattern 1:  Pattern 2: </p> <p>Pattern 3:  Pattern 4: </p> <p>Pattern 5: </p> <p><b>User Pattern:</b> Captures a user pattern.   "Saving User Pattern" <a href="#">p.99</a></p> <p><b>Test Pattern:</b> Displays a test pattern to adjust the projected status without connecting a device. While the test pattern is displayed, zoom, focus adjustments, and keystone correction can be performed. To cancel the Test Pattern, press the [Esc] button on the remote control or the control panel. To cancel the Test Pattern, press the [Esc] button on the remote control or the control panel. When you want to display a test pattern on a 4:3 screen using a wide-screen projector, select <b>Pattern 5</b> from <b>Pattern Type</b>.</p> <div style="border: 1px solid black; padding: 5px; margin-top: 10px;"> <p><b>Attention</b></p> <p>If a pattern is displayed for a long time, a residual image may be visible in projected images.</p> </div>

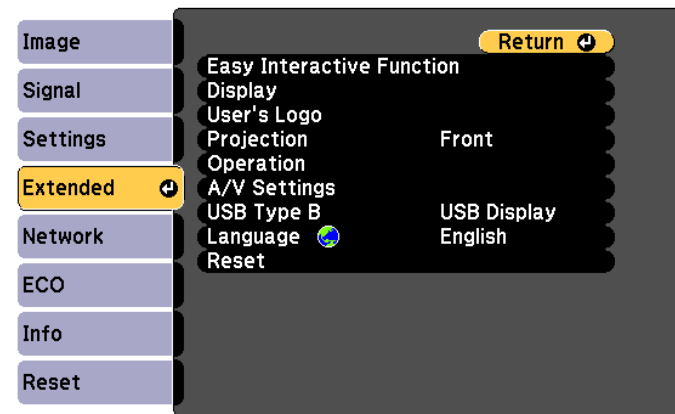

Sub-menu	Function
<b>Reset</b>	<p>You can reset all adjustment values in the <b>Settings</b> menu to their default settings, except for <b>Zoom</b>, <b>User Button</b>, and <b>Image Shift</b>.</p> <p>See the following to return all menu items to their default settings.</p> <p> "Reset Menu" <a href="#">p.137</a></p>

## Extended Menu



Sub-menu	Function
<b>Easy Interactive Function (EB-585Wi/EB-575Wi only)</b>	<p>Allows you to use and set the interactive features.</p> <p> "Using the Interactive Features (EB-585Wi/EB-575Wi only)" <a href="#">p.62</a></p> <p>See the following table for more details.</p> <p> "Easy Interactive Function Setting Items" <a href="#">p.126</a></p>

Sub-menu	Function
<b>Display</b>	<p>You can make settings related to the projector's display.</p> <p><b>Messages:</b> When set to <b>Off</b>, the following items will not be displayed.</p> <p>Item names when the Source, Color Mode, or Aspect Ratio is changed, messages when no signal is being input, and warnings such as High Temp Warning.</p> <p><b>Display Background*1:</b> You can set the screen status for when no image signal is available to <b>Black</b>, <b>Blue</b>, or <b>Logo</b>.</p> <p><b>Startup Screen*1:</b> Set to <b>On</b> to display the <b>User's Logo</b> when projection starts.</p> <p><b>A/V Mute*1:</b> You can set the screen displayed when the remote control's [A/V Mute] button is pressed to <b>Black</b>, <b>Blue</b>, or <b>Logo</b>.</p> <p><b>Toolbars</b> (EB-585Wi/EB-575Wi only): Set whether or not the drawing toolbar tab is always displayed when using the interactive features. The default is <b>Hide for Set Time</b>.</p> <p><b>Pen Mode Icon</b> (EB-585Wi/EB-575Wi only): Set whether or not to always display the icon to change the pen mode when using the interactive features. The icon is hidden when set to <b>Off</b>.</p> <p><b>Projector Control</b> (EB-585Wi/EB-575Wi only): Set the display position for the projector control toolbar when using the interactive features. The default value is <b>Bottom</b>. The icon is hidden when set to <b>Off</b>.</p>
<b>User's Logo*1</b>	<p>You can change the user's logo that is displayed as a background during Display Background, A/V Mute, and so on.</p> <p> "Saving a User's Logo" <a href="#">p.97</a></p>

Sub-menu	Function
<b>Projection</b>	<p>Select from one of the following projection methods depending on how the projector is installed.</p> <p><b>Front</b>, <b>Front/Upside Down</b>, <b>Rear</b>, and <b>Rear/Upside Down</b></p> <p>You can change the Projection setting as follows by holding down the [A/V Mute] button on the remote control for about five seconds.</p> <p><b>Front↔Front/Upside Down</b></p> <p><b>Rear↔Rear/Upside Down</b></p> <p> "Installation Methods" <a href="#">p.25</a></p>
<b>Operation</b>	<p><b>Direct Power On:</b> Set to <b>On</b> to turn on the projector simply by plugging it in.</p> <p>When the power cord is plugged in, note that the projector turns on automatically in cases such as a power outage being restored.</p> <p><b>High Altitude Mode:</b> Set to <b>On</b> when using the projector above an altitude of 1500 m or higher.</p> <p><b>Startup Source Search:</b> Set to <b>Off</b> to project images from the same source as the last time the projector was used.</p> <p><b>Monitor Out Port:</b> Changes the input and output for the Computer2/Monitor Out ports. When outputting images to an external monitor, select <b>Monitor Out</b>. When inputting image signals from a computer or component video signals from other video sources, select <b>Computer2</b>.</p> <p> "Interface" <a href="#">p.13</a></p>

Sub-menu	Function
<b>A/V Settings</b>	<p><b>A/V Output:</b> (Only available when <b>Standby Mode</b> is set to <b>Communication On</b>.)</p> <p>To perform the following functions when the projector is in standby, set to <b>Always On</b>.</p> <ul style="list-style-type: none"> <li>• Outputting audio and images to external devices.</li> <li>• Outputting microphone audio from the projector's speaker.</li> </ul> <div style="border: 1px solid black; padding: 5px; margin: 10px 0;">  Although the fan may rotate in standby mode, this is not an abnormality.         </div> <p><b>Audio Output:</b> Set the audio input port when projecting images from the Computer1, Computer2, S-Video, Video, and USB-A ports. When set to <b>Audio1</b>, <b>Audio2</b>, or <b>Audio3</b>, audio is output from the selected port regardless of the source (when set to <b>Audio3</b>, audio is output from the Audio port).</p> <p><b>HDMI1 Audio Output/HDMI2 Audio Output:</b> Set the input audio when projecting images from the HDMI1 or HDMI2 port. When set to <b>Audio1</b>, <b>Audio2</b>, or <b>Audio3</b>, audio is output from the selected audio input port (when set to <b>Audio3</b>, audio is output from the Audio port).</p>

Sub-menu	Function
<b>USB Type B (EB-585Wi/EB-575Wi only)</b>	<p><b>Easy Interactive Function:</b> Allows you to use the interactive features to operate computers (computer interactive mode). USB Display and Wireless Mouse functions are not available.</p> <p><b>USB Display/Easy Interactive Function:</b> Allows you to use the interactive features to operate computers (computer interactive mode) and USB Display. The Wireless Mouse function is not available.</p> <p><b>Wireless Mouse/USB Display:</b> Allows you to use the Wireless Mouse function and USB Display. You cannot use the interactive features to operate computers (computer interactive mode).</p> <ul style="list-style-type: none"> <li>☛ "Projecting with USB Display" <a href="#">p.47</a></li> <li>☛ "Controlling Computer Features from a Projected Screen (Computer Interactive Mode)" <a href="#">p.66</a></li> <li>☛ "Using the Remote Control to Operate the Mouse Pointer (Wireless Mouse)" <a href="#">p.95</a></li> </ul>
<b>Language</b>	Allows you to set the language for messages and menus.
<b>Reset</b>	<p>You can reset the adjustment values for <b>Display</b><sup>*1</sup>, <b>Operation</b><sup>*2</sup>, and <b>A/V Settings</b><sup>*3</sup> from the <b>Extended</b> menu to their default settings. See the following to return all menu items to their default settings.</p> <ul style="list-style-type: none"> <li>☛ "Reset Menu" <a href="#">p.137</a></li> </ul>

\*1 Except for **Toolbars**, **Pen Mode Icon**, and **Projector Control**. Except for **Display Background**, **Startup Screen**, and **User's Logo** when **User's Logo Protection** is set to **On**.

☛ "Managing Users (Password Protection)" [p.101](#)

\*2 Except for **High Altitude Mode**, **Startup Source Search**, and **Monitor Out Port**.

\*3 Except for **A/V Output**.

## Easy Interactive Function Setting Items

### General

Sub-menu	Function
<b>Auto Calibration</b>	Starts auto calibration.
<b>Manual Calibration</b>	Starts manual calibration.
<b>Pen Mode</b>	(This can only be set when projecting images from a computer.) Changes the function for the interactive pen. When set to <b>PC Free Annotation</b> (default), you can draw on the projected screen. When set to <b>PC Interactive</b> , you can operate a computer from the projected screen. You can change the interactive pen function with the [Pen Mode] button on the remote control, or the pen mode icon on the projected screen.
<b>Hovering</b>	When set to <b>On</b> (default), the pointer follows the pen tip as you hover it over the screen and move it around.

Sub-menu	Function
<b>Advanced</b>	<ul style="list-style-type: none"> <li>• <b>Distance of Projectors:</b> When using multiple projectors in the same room, adjust the interactive pen operations according to the distance between the projectors. If interactive pen operations are unstable, try another mode. The standard distance set for <b>Mode 1</b> is 2 m.</li> <li>• <b>Sync of Projectors:</b> When using multiple projectors in the same room, select the method for controlling the interactive pen interference. When set to <b>Infrared</b> (default), only infrared is used to synchronize. Set to <b>Wired</b> when connecting the projectors using cables.   "Connecting Multiple Projectors (EB-585Wi/EB-575Wi only)" p.41</li> <li>• <b>Wired Sync Mode:</b> When set to <b>Mode 1</b> (default), only cable connections are used to synchronize. When set to <b>Mode 2</b>, and <b>Sync of Projectors</b> is set to <b>Wired</b>, infrared synchronization is also performed at the same time. Set to <b>Mode 2</b> when using in the same room as projectors that do not support cable connections.</li> <li>• <b>Pen Button Function:</b> When set to <b>Eraser</b> (default), the tip function changes between pen and eraser whenever you press the button on the side of the interactive pen.</li> <li>• <b>Confirm Clear Screen:</b> When set to <b>On</b> (default), a confirmation screen is displayed before clearing all of the content drawn on the projected screen.</li> <li>• <b>Color Palette:</b> When set to <b>Palette 2</b>, it changes to a color palette suitable for people who are color blind. Try <b>Palette 2</b> if you find it hard to see the default color palette.</li> </ul>

## PC Interactive

Set when you want to operate a computer from the projected screen.

Sub-menu	Function
<b>Pen Operation Mode</b>	Set the operation mode and the number of users for the interactive pen. <b>Two Users/Mouse (default)/One User/Mouse:</b> Allows you to perform mouse operations using the interactive pen. <b>One User/Pen:</b> The pen input and Ink features are available in Windows 8.1, Windows 8, Windows 7, and Windows Vista.
<b>Enable Right Click</b>	(Only available when <b>Pen Operation Mode</b> is set to <b>Two Users/Mouse</b> or <b>One User/Mouse</b> .) When this is set to <b>On</b> , a long press of the pen acts as a right click.
<b>Advanced</b>	<ul style="list-style-type: none"> <li>• <b>Pen Tip Button:</b> Allows you to set operations for the pen tip of the interactive pen. The default setting is <b>Left Click</b>.</li> <li>• <b>Auto Adjust Pen Area:</b> When this is set to <b>On</b> (default), the pen area is automatically adjusted as the resolution for the connected computer changes. Set to <b>Off</b> if you do not want to automatically adjust the pen area that has been manually adjusted.</li> <li>• <b>Manual Adj. Pen Area:</b> Adjusts the pen area manually.</li> </ul>

## Network Menu

When **Network Protection** is set to **On** in **Password Protection**, a message is displayed and the network settings cannot be changed. Set **Network Protection** to **Off** and then configure the network.

## "Setting Password Protection" p.101

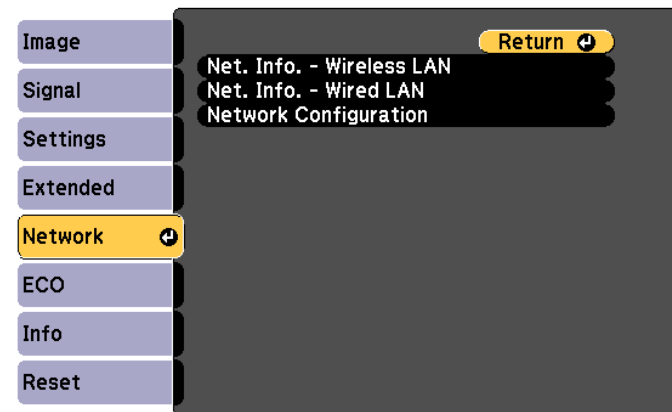

Sub-menu	Function
<b>Net. Info. - Wireless LAN</b>	Displays the following network setting status information. <ul style="list-style-type: none"> <li>• Connection Mode</li> <li>• Wireless LAN Sys.</li> <li>• Antenna Level</li> <li>• Projector Name</li> <li>• SSID</li> <li>• DHCP</li> <li>• IP Address</li> <li>• Subnet Mask</li> <li>• Gateway Address</li> <li>• MAC Address</li> <li>• Region Code*</li> </ul>
<b>Net. Info. - Wired LAN</b>	Displays the following network setting status information. <ul style="list-style-type: none"> <li>• Projector Name</li> <li>• DHCP</li> <li>• IP Address</li> <li>• Subnet Mask</li> <li>• Gateway Address</li> <li>• MAC Address</li> </ul>

Sub-menu	Function
<b>Network Configuration</b>	The following menus are available for setting network items. <b>Basic, Wireless LAN, Security, Wired LAN, Mail, Others, Reset, and Setup complete</b>

\* Displays available region information for the Wireless LAN unit being used. For more details, contact your local dealer or the nearest address provided in the Epson Projector Contact List.

[Epson Projector Contact List](#)

- By using a Web browser of a computer connected to the projector on a network, you can set functions and control the projector. This function is called Web Control. You can easily enter text using a keyboard to make settings for Web Control such as Security settings.
  - "Changing Settings Using a Web Browser (Web Control)" p.105
- Contact your network administrator for details on network settings.

## Notes on Operating the Network Menu

Selecting from the top menu and sub menus, and changing selected items is the same as making operations from the Configuration menu.

When done, make sure you go to the **Setup complete** menu, and select one of **Yes**, **No**, or **Cancel**. When you select **Yes** or **No**, you return to the Configuration menu.

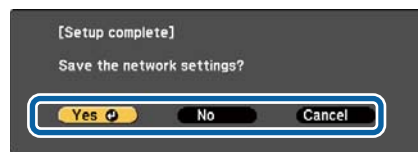
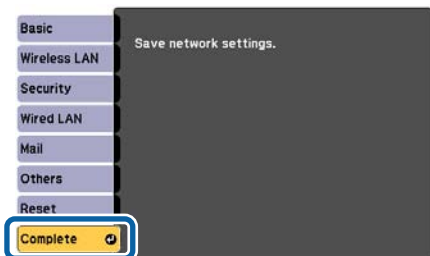

**Yes:** Saves the settings and exits the Network menu.

**No:** Does not save the settings and exits the Network menu.

**Cancel:** Continues displaying the Network menu.

## Soft Keyboard Operations

The Network menu contains items that require input of alphanumerics during setup. In this case, the following software keyboard is displayed. Use the [←], [→], [⏪], and [⏩] buttons on the remote control or the [△], [▽], [Wide], and [Tele] buttons on the control panel to move the cursor to the key you want, and then press the [Enter] button to enter the alphanumerical character. Enter figures by holding down the [Num] button on the remote control, and pressing the numeric buttons. After inputting, press **Finish** on the keyboard to confirm your input. Press **Cancel** on the keyboard to cancel your input.

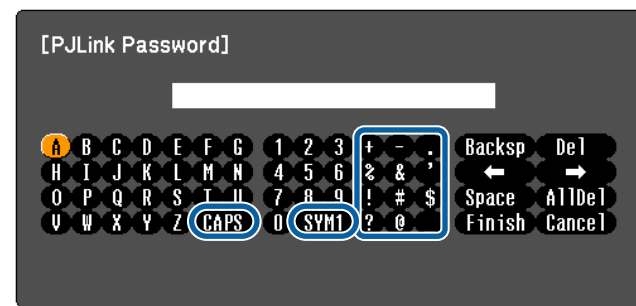

- Each time the **CAPS** key is selected and the [Enter] button is pressed, it switches between upper case and lower case.
- Each time the **SYM1/2** key is selected and the [Enter] button is pressed, it sets and changes the symbol keys for the section enclosed by the frame.

The following text can be entered.

Numbers	0123456789
---------	------------



Alphabet	ABCDEFGHIJKLMNOPQRSTUVWXYZ abcdefghijklmnopqrstuvwxyz
Symbols	! # \$ % & ' ( ) + - . / < = > ? @ ^ _ ` {   } ~

- Colons (: ) cannot be entered on the Network menu.
- Except for the **SSID**, spaces cannot be entered on the Network menu.
- Some symbols (" \* , ; [ \ ] ^) cannot be entered using the software keyboard. Use your Web browser to enter the text.
- ☛ "Changing Settings Using a Web Browser (Web Control)" [p.105](#)

## Basic Menu

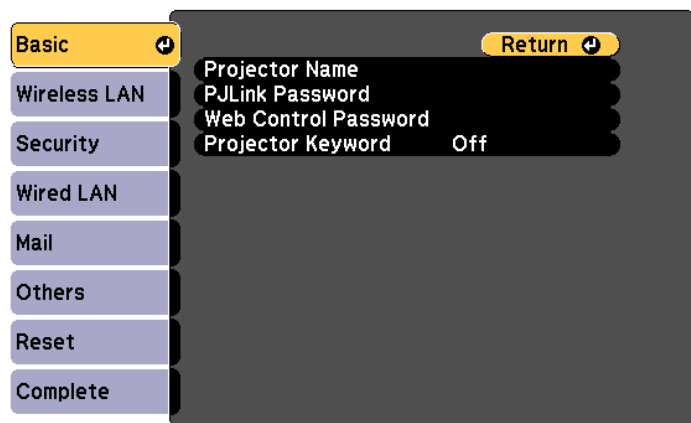

Sub-menu	Function
<b>Projector Name</b>	Displays the projector name used to identify the projector when connected to a network. When editing, you can enter up to 16 single-byte alphanumeric characters. The following symbols cannot be used: " * + , / ; < = > ? [ \ ] `

Sub-menu	Function
<b>PJLink Password</b>	Set a password to use when you access the projector using compatible PJLink software. You can enter up to 32 single-byte alphanumeric characters (symbols cannot be used).
<b>Web Control Password</b>	Set a password to use when making settings and controlling the projector using Web Control. You can enter up to eight single-byte alphanumeric characters (* cannot be used). The default password is "admin". Web Control is a computer function that allows you to set up and control the projector by using the Web browser on a computer connected on a Network. ☛ "Changing Settings Using a Web Browser (Web Control)" <a href="#">p.105</a>
<b>Projector Key-word</b>	When set to <b>On</b> , you have to enter the keyword when you try to connect the projector to a computer via a network. As a result, you can prevent presentations from being interrupted by connections from other computers. Normally this should be set to <b>On</b> . ☛ <a href="#">EasyMP Network Projection Operation Guide</a> ☛ <a href="#">EasyMP Multi PC Projection Operation Guide</a>

Wireless LAN Menu

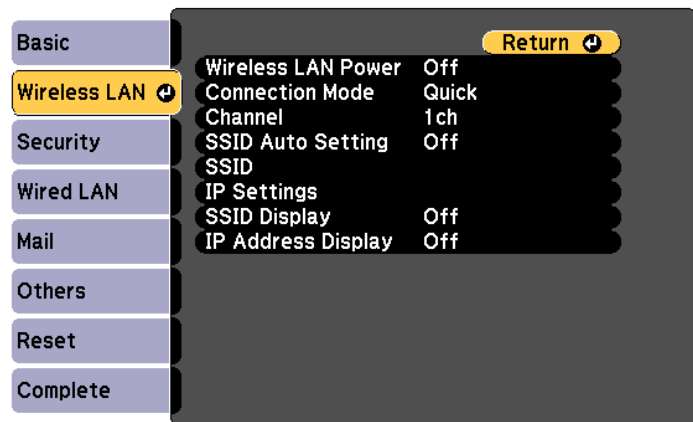

Sub-menu	Function
<b>Wireless LAN Power</b>	Turn <b>On</b> when connecting the projector to the computer over wireless LAN. If you do not want to connect via wireless LAN, turn it <b>Off</b> to prevent unauthorized access by others. This is set to <b>On</b> by default.
<b>Connection Mode</b>	Set the connection mode to use when connecting the projector and a computer via a wireless LAN. If you select <b>Quick</b> (default), a small network is created automatically by the projector and computer. Used in combination with EasyMP Network Projection. When <b>SSID Auto Setting</b> is set to <b>On</b> , the projector becomes an easy access point. When set to <b>Off</b> , the network is created in <u>Ad hoc mode</u> ▶▶. If you select <b>Advanced</b> , the connection is established in <u>infrastructure mode</u> ▶▶ through the access point installed. See the following manual for details on Connection Mode. ☛ <a href="#">EasyMP Network Projection Operation Guide</a> ☛ <a href="#">EasyMP Multi PC Projection Operation Guide</a>

Sub-menu	Function
<b>Channel</b>	(This can only be set if <b>Connection Mode</b> is set to <b>Quick</b> .) Select the frequency band used by the wireless LAN from <b>1ch</b> , <b>6ch</b> , or <b>11ch</b> . This is set to <b>11ch</b> by default.
<b>SSID Auto Setting</b>	(This can only be set if <b>Connection Mode</b> is set to <b>Quick</b> .) Set to <b>On</b> to speed up the projector search. Set to <b>Off</b> when connecting to multiple projectors at the same time. This is set to <b>On</b> by default.
<b>SSID</b>	(This can be set only if <b>SSID Auto Setting</b> is set to <b>Off</b> .) Enter an <u>SSID</u> ▶▶. When an SSID is provided for the wireless LAN system in which the projector participates, enter the SSID. You can enter up to 32 single-byte alphanumeric characters. If the SSID is left blank or set to ANY, an ANY connection (selects a connection from local access points without specifying an SSID) is established.

Sub-menu	Function
IP Settings	<p>(This can be set only if <b>Connection Mode</b> is set to <b>Advanced</b>.)                      You can make network settings.  <b>DHCP:</b> Set to <b>On</b> to make network settings using <b>DHCP</b>. If this is set to <b>On</b>, you cannot set any more addresses.  <b>IP Address:</b> You can input the <b>IP address</b> assigned to the projector. You can enter a number from 0 to 255 in each field of the address. However, the following IP addresses cannot be used.                      0.0.0.0, 127.x.x.x, 224.0.0.0 to 255.255.255.255 (where x is a number from 0 to 255)  <b>Subnet Mask:</b> You can input the <b>subnet mask</b> for the projector. You can enter a number from 0 to 255 in each field of the address. However, the following subnet masks cannot be used.                      0.0.0.0, 255.255.255.255  <b>Gateway Address:</b> You can input the IP address for the gateway for the projector. You can enter a number from 0 to 255 in each field of the address. However, the following <b>Gateway addresses</b> cannot be used.                      0.0.0.0, 127.x.x.x, 224.0.0.0 to 255.255.255.255 (where x is a number from 0 to 255)</p>
SSID Display	To prevent the <b>SSID</b> from being displayed on the LAN Standby screen, set this to <b>Off</b> .
IP Address Display	To prevent the <b>IP address</b> from being displayed on the LAN Standby screen, set this to <b>Off</b> .

### Security Menu

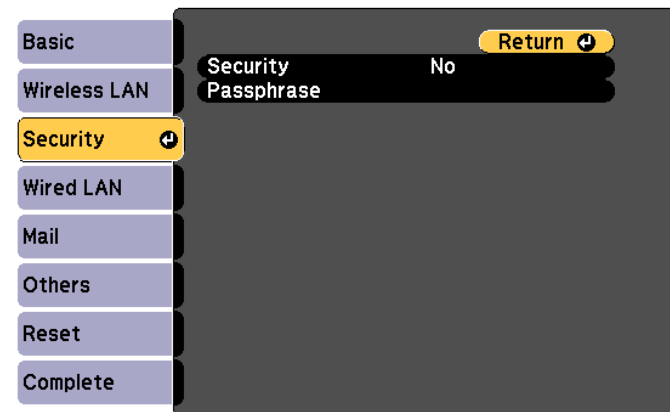

Sub-menu	Function
Security	Select the security type from the items that are displayed. When setting security, follow the instructions from the administrator of the network system you are about to access.
Passphrase	<p>(This can only be selected when <b>Security</b> is set to <b>WPA2-PSK</b> or <b>WPA/WPA2-PSK</b>.)                      Enter the passphrase. You can enter at least 8 and up to 63 single-byte alphanumeric characters.                      When using with EasyMP Network Projection, you do not need to enter the passphrase in the computer if it is the initial (default) passphrase.                      ☛ "Reset Menu" <a href="#">p.135</a>                      You can enter up to 32 characters on the Configuration menu. When entering more than 32 characters, use your Web browser to enter the text.                      ☛ "Changing Settings Using a Web Browser (Web Control)" <a href="#">p.105</a>                      When <b>Connection Mode</b> is set to <b>Quick</b>, the initial passphrase is set.</p>

## Type of security

When the optional wireless LAN unit is installed and being used in Advanced connection mode, it is strongly recommended that you set security.

WPA is an encryption standard that improves the security for wireless networks. The projector supports TKIP and AES encryption methods.

WPA also includes user authentication functions. WPA authentication provides two methods: using an authentication server, or authenticating between a computer and an access point without using a server. This projector supports the latter method, without a server.



For setting details, follow the instructions from your network administrator.

## Wired LAN Menu

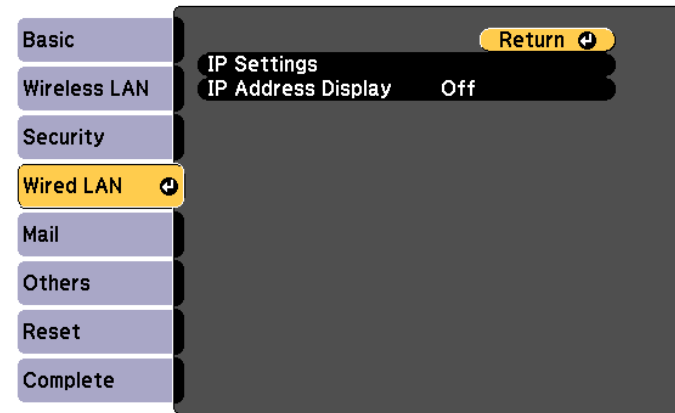

Sub-menu	Function
IP Settings	<p>You can make settings related to the following addresses.</p> <p><b>DHCP</b>: Set to <b>On</b> to configure the network using DHCP. If this is set to <b>On</b>, you cannot set any more addresses.</p> <p><b>IP Address</b>: You can input the IP address assigned to the projector. You can input a number from 0 to 255 in each field of the address. However, the following IP addresses cannot be used. 0.0.0.0, 127.x.x.x, 224.0.0.0 to 255.255.255.255 (where x is a number from 0 to 255)</p> <p><b>Subnet Mask</b>: You can input the subnet mask for the projector. You can input a number from 0 to 255 in each field of the address. However, the following subnet masks cannot be used. 0.0.0.0, 255.255.255.255</p> <p><b>Gateway Address</b>: You can input the IP address for the gateway for the projector. You can input a number from 0 to 255 in each field of the address. However, the following gateway addresses cannot be used. 0.0.0.0, 127.x.x.x, 224.0.0.0 to 255.255.255.255 (where x is a number from 0 to 255)</p>

Sub-menu	Function
<b>IP Address Display</b>	To prevent the IP address from being displayed on Network Info in the Network menu and on the LAN Standby screen, set this to Off.

## Mail Menu

When this is set, you receive an email notification if a problem or warning occurs in the projector.

☛ "Using the Mail Notification Function to Report Problems" p.107

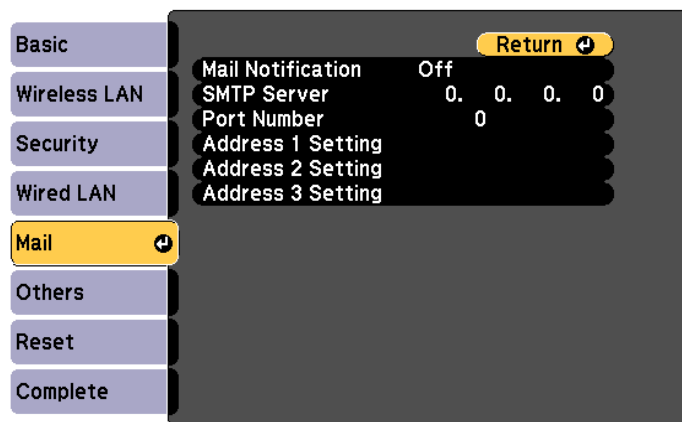

Sub-menu	Function
<b>Mail Notification</b>	Set to <b>On</b> to send an email to the preset addresses when a problem or warning occurs with a projector.
<b>SMTP Server</b>	You can input the <u>IP address</u> for the SMTP server for the projector. You can enter a number from 0 to 255 in each field of the address. However, the following IP addresses cannot be used. 127.x.x.x, 224.0.0.0 to 255.255.255.255 (where x is a number from 0 to 255)

Sub-menu	Function
<b>Port Number</b>	You can input the port number for the SMTP server. The default value is 25. You can input numbers between 1 to 65535.
<b>Address 1 Setting/Address 2 Setting/Address 3 Setting</b>	You can input the email address of the destination to send the notification email to. You can register up to three destinations. You can enter up to 32 single-byte alphanumeric characters for the email address. The following characters cannot be used: " ( ) , ; < > [ \ ] The address for destination 1 is the mail notification sender's address. You can select the problems or warnings to be notified about by email. When the selected problem or warning occurs in the projector, an email is sent to the specified destination address notifying that a problem or warning has occurred. You can select multiple items from the displayed items.

Others Menu

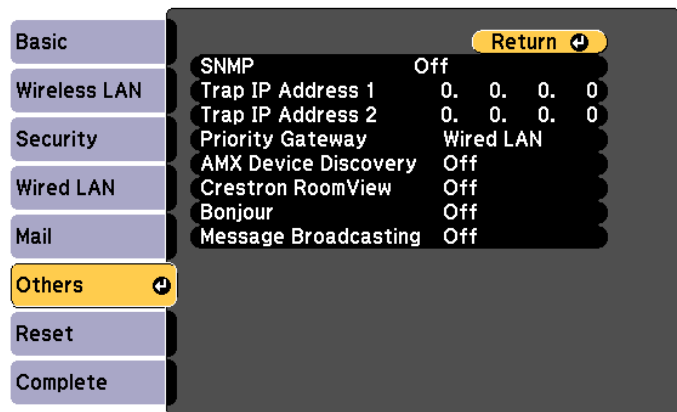

Sub-menu	Function
<b>SNMP</b>	Set to <b>On</b> to monitor the projector using SNMP. To monitor the projector, you need to install the SNMP manager program on your computer. SNMP should be managed by a network administrator. The default value is <b>Off</b> .
<b>Trap IP Address 1/Trap IP Address 2</b>	You can register up to two IP addresses for the SNMP trap notification destination. You can enter a number from 0 to 255 in each field of the address. However, the following IP addresses cannot be used. 127.x.x.x, 224.0.0.0 to 255.255.255.255 (where x is a number from 0 to 255)
<b>Priority Gateway</b>	You can set the priority gateway to a <b>Wired LAN</b> or <b>Wireless LAN</b> .
<b>AMX Device Discovery</b>	When the projector is connected to a network, set this to <b>On</b> to allow the projector to be detected by <u>AMX Device Discovery</u> . Set this to <b>Off</b> if you are not connected to an environment controlled by a controller from AMX or AMX Device Discovery.

Sub-menu	Function
<b>Crestron RoomView</b>	Set this to <b>On</b> only when monitoring or controlling the projector over the network using Crestron RoomView®. Otherwise, set this to <b>Off</b> . ☛ "About Crestron RoomView®" p.111 When this is set to <b>On</b> , the following functions are not available. <ul style="list-style-type: none"> <li>• Web Control</li> <li>• Message Broadcasting (EasyMP Monitor Plug-in)</li> </ul>
<b>Bonjour</b>	Set this to <b>On</b> when connecting to the network using Bonjour. See Apple's Web site for more information on the Bonjour service. <a href="http://www.apple.com/">http://www.apple.com/</a>
<b>Message Broadcasting</b>	You can switch the EPSON Message Broadcasting function to enable or disable.

### Reset Menu

Resets all of the network settings.

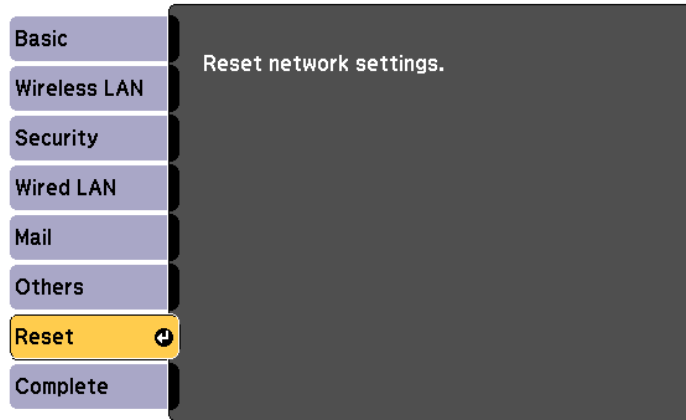

Sub-menu	Function
Reset network settings.	To reset all of the Network settings, select <b>Yes</b> .

### ECO Menu

When you make ECO menu settings, the projector performs functions to save power. When power saving settings have been enabled, a leaf icon is displayed next to each submenu.

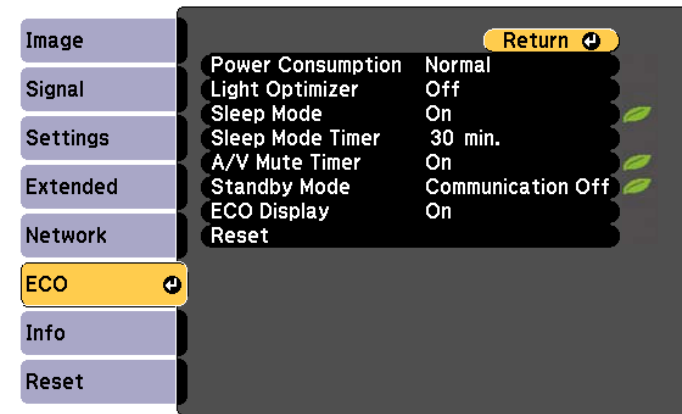

Sub-menu	Function
<b>Power Consumption</b>	<p>You can set the lamp brightness to one of two settings. Select <b>ECO</b> if the images being projected are too bright, such as when projecting images in a dark room or onto a small screen. When <b>ECO</b> is selected, power consumption during projection decreases, and fan rotation noise is reduced.</p> <p>When <b>Auto</b> is set, the surrounding brightness is detected by the illumination sensor, and the lamp's brightness is automatically adjusted.</p> <p>When using at high altitude or in locations subject to high temperatures, you may not be able to change settings.</p>

Sub-menu	Function
<b>Light Optimizer</b>	(This item can only be set when <b>Power Consumption</b> is set to <b>Normal</b> or <b>Auto</b> .) When set to <b>On</b> , the lamp brightness is adjusted according to the image being projected. This helps to reduce the amount of electricity being used by lowering the lamp's brightness according to the scene being projected. The setting is stored for each Color Mode.
<b>Sleep Mode</b>	When set to <b>On</b> , this automatically stops projection when no image signal is being input and no operations are carried out for a specified length of time. Also, if no image signal is input for a specified length of time, the lamp dims until the power turns off. When an image signal is input, the projector returns to normal operating status.
<b>Sleep Mode Timer</b>	When <b>Sleep Mode</b> is set to <b>On</b> , you can set the time before the projector automatically turns off within a range of 1 to 30 minutes.
<b>A/V Mute Timer</b>	When set to <b>On</b> , this turns off the power automatically 30 minutes after A/V mute is enabled. Also, if A/V mute is enabled and a specified length of time has passed, the lamp dims until the power turns off. When A/V mute is disabled, the projector returns to normal operating status.
<b>Standby Mode</b>	If you set <b>Communication On</b> , you can perform the following operations even if the projector is in standby mode. <ul style="list-style-type: none"> <li>• Monitor and control the projector from a computer over the network</li> <li>• Output audio and images to an external device (only when <b>A/V Output</b> is set to <b>Always On</b>)</li> <li>• Output microphone audio from the projector's speaker (only when <b>A/V Output</b> is set to <b>Always On</b>)</li> </ul>
<b>ECO Display</b>	When set to <b>On</b> , when the lamp brightness changes from normal to low or low to normal, leaf icons are displayed at the bottom-left of the projected screen to indicate the power-saving status.

Sub-menu	Function
<b>Reset</b>	You can reset all adjustment values on the <b>ECO</b> menu to their default settings, except for <b>Standby Mode</b> . See the following to return all menu items to their default settings. ☛ "Reset Menu" <a href="#">p.137</a>

## Info Menu (Display only)

Lets you check the status of the image signals being projected and the status of the projector. Items that can be displayed vary depending on the source currently being projected. Depending on the model used, some input sources are not supported.

☛ "Automatically Detect Input Signals and Change the Projected Image (Source Search)" [p.45](#)

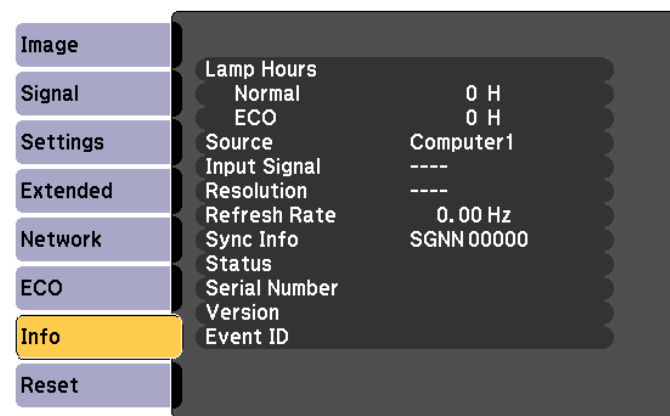

Sub-menu	Function
<b>Lamp Hours</b>	You can display the cumulative lamp operating time*. When the lamp replacement time is reached, the characters are displayed in yellow.



Sub-menu	Function
<b>Source</b>	You can display the source name for the connected equipment currently being projected.
<b>Input Signal</b>	You can display the content of <b>Input Signal</b> set in the <b>Signal</b> menu according to the source.
<b>Resolution</b>	You can display the resolution.
<b>Video Signal</b>	You can display the settings for <b>Video Signal</b> in the <b>Signal</b> menu.
<b>Refresh Rate</b>	You can display the <u>refresh rate</u> ▶▶.
<b>Sync Info</b>	You can display the image signal Information. It may be needed if service is required.
<b>Status</b>	This information is about errors that have occurred with the projector. It may be needed if service is required.
<b>Version</b>	Displays the projector's firmware version information.
<b>Serial Number</b>	Displays the projector's serial number.
<b>Event ID</b>	Displays the application error log. ☛ "About Event ID" <a href="#">p.159</a>

\* The cumulative use time is displayed as "0H" for the first 10 hours. 10 hours and above is displayed as "10H", "11H", and so on.

## Reset Menu

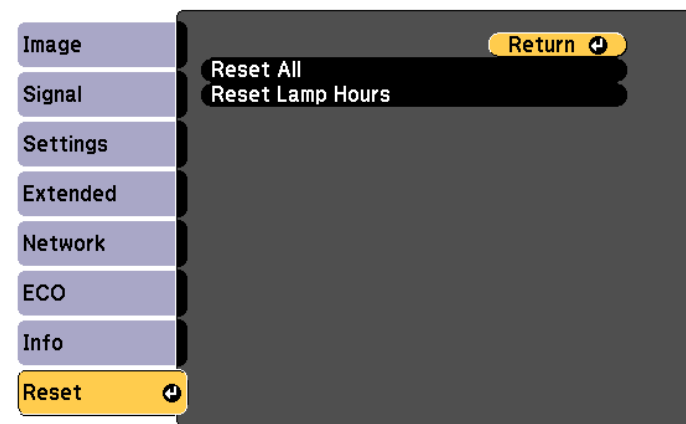

Sub-menu	Function
<b>Reset All</b>	You can reset all items in the Configuration menu to their default settings. The following items are not reset to their defaults: <b>Input Signal, Zoom, User's Logo</b> , all items in the <b>Network</b> menu, <b>Lamp Hours, Language, Password</b> , and <b>Image Shift</b> .
<b>Reset Lamp Hours</b>	Clears the cumulative lamp hours use time. Reset this when you replace the lamp.

Once the Configuration menu content has been set for one projector, you can use it to perform batch setup for multiple projectors (batch setup function).

Use one of the following methods.

- Setup using a USB memory.
- Setup by connecting the computer and projector with a USB cable.
- Setup using EasyMP Network Updater.

For more details, see the *Installation Guide*.

 [Installation Guide](#)



# Troubleshooting

This chapter describes how to identify problems and what to do if a problem is found.

If a problem occurs with the projector, the Help screen is displayed to assist you by pressing the Help button. You can solve problems by answering the questions.

- 1 Press the [Help] button.  
The Help screen is displayed.

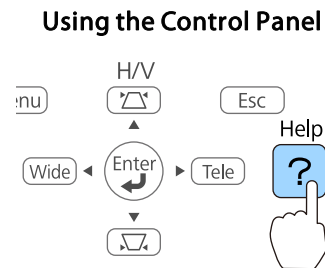
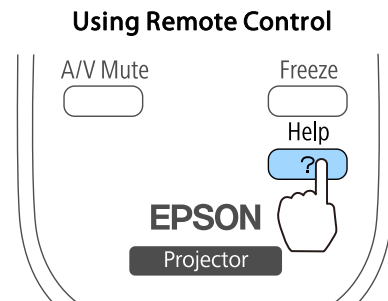

- 2 Select a menu item.

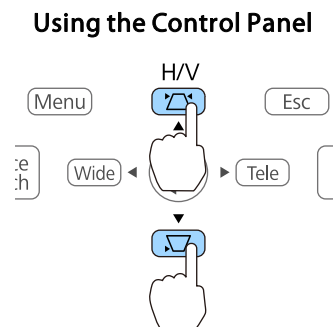
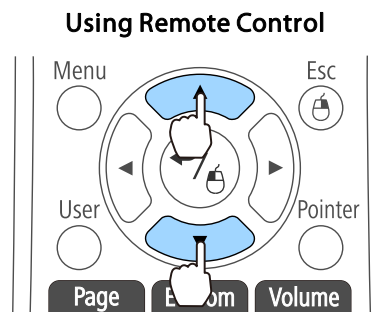
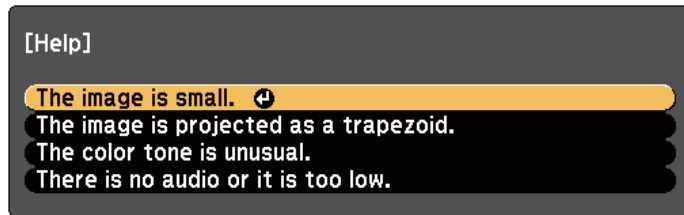

- 3 Confirm the selection.

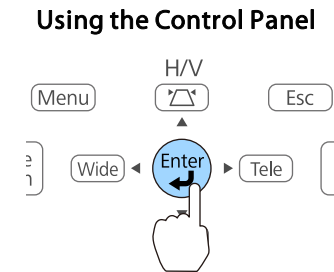
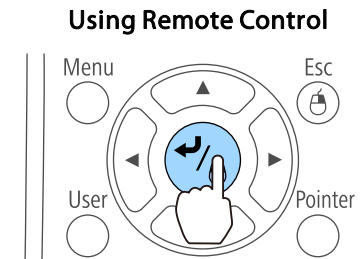

Questions and solutions are displayed as shown on the screen below. Press the [Help] button to exit the Help.

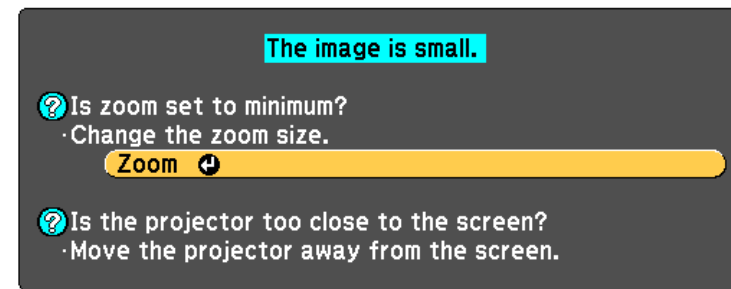

See the following if the Help function does not provide a solution to the problem.

☞ "Problem Solving" p.141

If you are having a problem with the projector, first check the projector's indicators and see "Reading the Indicators".

See the following if the indicators do not show clearly what the problem might be.

☛ "When the Indicators Provide No Help" [p.145](#)

## Reading the Indicators

The projector is provided with the following four indicators. The color and lit status of the indicators shows the status of the projector.

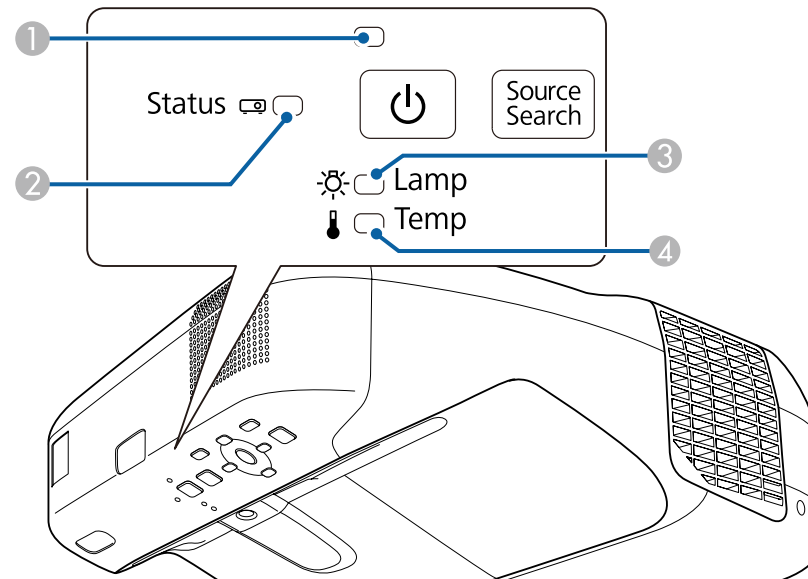

- ① Power indicator
- ② Status indicator
- ③ Lamp indicator





Indicates the projector's status.

Indicates the projector's status.

Indicates the projection lamp status.

## 4 Temp indicator







Indicates the internal temperature status.







Indicators		Status	Explanation
Power	Status		
 Blue - Lit	<input type="checkbox"/> Off	Standby condition	Power is being supplied to the projector. When the [⏻] power button is pressed in this condition, projection starts.
		Network monitoring status	The projector is being monitored and controlled over a network (when <b>Standby Mode</b> is set to <b>Communication On</b> ). If the power cord is disconnected and then reconnected in this status, the power indicator flashes blue.
 Blue - Lit	 Blue - Flashing	Warm-up status	This is the status immediately after turning on the projector. Warm-up takes approximately 30 seconds after the lamp turns on. In this status you cannot turn off the projector, even if you press the [⏻] power button.
		Cool down status	This is the status immediately after turning off the projector. In this status, all buttons are disabled.
 Blue - Lit	 Blue - Lit	Normal status	The projector is projecting.

















See the following table for the status of indicators and how to resolve the problems.

If all indicators are off, check that the power cord is connected correctly and that the power is being supplied normally.

Sometimes, when the power cord is unplugged, the [⏻] power indicator remains lit for a short period, but this is not a fault.

Indicators				Cause	Remedy or Status
Power	Status	Lamp	Temp		
<input type="checkbox"/> Off	 Blue - Flashing	 Orange - Flashing	<input type="checkbox"/> Off	Internal Error	Stop using the projector, remove the power plug from the electrical outlet, and contact your local dealer or the nearest address provided in the Epson Projector Contact List.  <a href="#">Epson Projector Contact List</a>
<input type="checkbox"/> Off	 Blue - Flashing	<input type="checkbox"/> Off	 Orange - Flashing	Fan Error Sensor Error	Stop using the projector, remove the power plug from the electrical outlet, and contact your local dealer or the nearest address provided in the Epson Projector Contact List.  <a href="#">Epson Projector Contact List</a>

Indicators				Cause	Remedy or Status
Power	Status	Lamp	Temp		
<input type="checkbox"/> Off	 Blue - Flashing	<input type="checkbox"/> Off	 Orange - Lit	High Temp Error (Overheating)	<p>The lamp turns off automatically and projection stops. Wait for approximately five minutes. After approximately five minutes the projector switches to standby mode, so check the following two points.</p> <ul style="list-style-type: none"> <li>• Check that the air filter and air exhaust vent are not blocked, and that the projector is not positioned against a wall.</li> <li>• If the air filter is clogged, clean or replace it.                             <ul style="list-style-type: none"> <li>☛ "Cleaning the Air Filter" <a href="#">p.162</a>, "Replacing the Air Filter" <a href="#">p.169</a></li> </ul> </li> </ul> <p>If the error continues after checking the points above, stop using the projector, remove the power plug from the electrical outlet, and contact your local dealer or the nearest address provided in the Epson Projector Contact List.</p> <p>☛ <a href="#">Epson Projector Contact List</a></p> <hr/> <p>When using at an altitude of 1500 m or more, set <b>High Altitude Mode</b> to <b>On</b>.</p> <p>☛ "Extended Menu" <a href="#">p.123</a></p>
<input type="checkbox"/> Off	 Blue - Flashing	 Orange - Lit	<input type="checkbox"/> Off	Lamp Error Lamp Failure	<p>Check the following two points.</p> <ul style="list-style-type: none"> <li>• Take out the lamp and check whether it is cracked.                             <ul style="list-style-type: none"> <li>☛ "Replacing the Lamp" <a href="#">p.165</a></li> </ul> </li> <li>• Clean the air filter.                             <ul style="list-style-type: none"> <li>☛ "Cleaning the Air Filter" <a href="#">p.162</a></li> </ul> </li> </ul> <p><b>If the lamp is not cracked:</b> Reinstall the lamp and plug in the power cord.</p> <p><b>If the error continues:</b> Stop using the projector, remove the power plug from the electrical outlet, and contact your local dealer or the nearest address provided in the Epson Projector Contact List.</p> <p>☛ <a href="#">Epson Projector Contact List</a></p> <p><b>If the lamp is cracked:</b> Contact your local dealer or the nearest address provided in the Epson Projector Contact List. (Images cannot be projected until the lamp is replaced.)</p> <p>☛ <a href="#">Epson Projector Contact List</a></p> <hr/> <p>When using at an altitude of 1500 m or more, set <b>High Altitude Mode</b> to <b>On</b>.</p> <p>☛ "Extended Menu" <a href="#">p.123</a></p>
<input type="checkbox"/> Off	 Blue - Flashing	 Orange - Flashing	 Orange - Flashing	Auto Iris Error	<p>Stop using the projector, remove the power plug from the electrical outlet, and contact your local dealer or the nearest address provided in the Epson Projector Contact List.</p> <p>☛ <a href="#">Epson Projector Contact List</a></p>

Indicators				Cause	Remedy or Status
Power	Status	Lamp	Temp		
 Off	 Blue - Flashing	 Orange - Lit	 Orange - Lit	Power Err.	
 Blue - Flashing	 State dependent indication	 State dependent indication	 Orange - Flashing	High Temp Warning	(This is not an abnormality. However, if the temperature rises too high again, projection stops automatically.) <ul style="list-style-type: none"> <li>• Check that the air filter and air exhaust vent are not blocked, and that the projector is not positioned against a wall.</li> <li>• If the air filter is clogged, clean or replace it.                             <ul style="list-style-type: none"> <li>☛ "Cleaning the Air Filter" <a href="#">p.162</a>, "Replacing the Air Filter" <a href="#">p.169</a></li> </ul> </li> </ul>
 Blue - Flashing	 State dependent indication	 Orange - Flashing	 State dependent indication	Replace Lamp	Replace it with a new lamp. <ul style="list-style-type: none"> <li>☛ "Replacing the Lamp" <a href="#">p.165</a></li> </ul> If you continue to use the lamp after the replacement period has passed, the possibility that the lamp may blow increases. Replace it with a new lamp as soon as possible.
 Off	 Blue - Flashing	 Orange - Lit	 Orange - Lit	Obstacle Detection Error	A beep sounds, and the message "For safety purposes remove any obstacles blocking the lens." is displayed. The projector will turn off automatically if no action is taken. Check the following two points. <ul style="list-style-type: none"> <li>• Check that there are no obstacles interfering with the projection window. Remove any obstacles.</li> <li>• Clean the obstacle sensor if there is no obstacle.                             <ul style="list-style-type: none"> <li>☛ "Cleaning the Obstacle Sensor" <a href="#">p.161</a></li> </ul> </li> </ul> If the error continues: Stop using the projector, remove the power plug from the electrical outlet, and contact your local dealer or the nearest address provided in the Epson Projector Contact List. <ul style="list-style-type: none"> <li>☛ <a href="#">Epson Projector Contact List</a></li> </ul>



- See the following if the projector is not operating properly, even though the indicators are all showing normal.
  - ☛ "When the Indicators Provide No Help" [p.145](#)
- If the indicators are in a state not shown in this table, stop using the projector, remove the power plug from the electrical outlet, and contact your local dealer or the nearest address provided in the Epson Projector Contact List.
  - ☛ [Epson Projector Contact List](#)



## When the Indicators Provide No Help

If any of the following problems occur and the indicators do not offer a solution, refer to the pages given for each problem.

### Problems Relating to Images

<ul style="list-style-type: none"> <li>• <b>No images appear</b> Projection does not start, the projection area is completely black or blue</li> </ul>	☞ p.146
<ul style="list-style-type: none"> <li>• <b>Moving images are not displayed (only the moving image portion turns black)</b> Moving images played back from a computer appear black and the images are not projected</li> </ul>	☞ p.147
<ul style="list-style-type: none"> <li>• <b>Projection stops automatically</b></li> </ul>	☞ p.147
<ul style="list-style-type: none"> <li>• <b>The message "Not supported" is displayed</b></li> </ul>	☞ p.147
<ul style="list-style-type: none"> <li>• <b>The message "No Signal" is displayed</b></li> </ul>	☞ p.148
<ul style="list-style-type: none"> <li>• <b>Images are fuzzy, out of focus, or distorted</b></li> </ul>	☞ p.148
<ul style="list-style-type: none"> <li>• <b>Interference or distortion appear in images</b></li> </ul>	☞ p.149
<ul style="list-style-type: none"> <li>• <b>The mouse cursor flickers (only when projecting USB Display)</b></li> </ul>	☞ p.150
<ul style="list-style-type: none"> <li>• <b>The image is truncated (large) or small, or the aspect ratio is not suitable</b> Only part of the image is displayed, or the height and width ratios of the image are not correct</li> </ul>	☞ p.150
<ul style="list-style-type: none"> <li>• <b>Image colors are not right</b> The whole image appears purplish or greenish, images are black &amp; white, or colors appear dull</li> </ul>	☞ p.151
<ul style="list-style-type: none"> <li>• <b>Images appear dark</b></li> </ul>	☞ p.151

### Problems when Projection Starts

<ul style="list-style-type: none"> <li>• <b>The projector does not turn on</b></li> </ul>	☞ p.152
---	---------

### Problems with the Interactive Features

<ul style="list-style-type: none"> <li>• <b>Cannot draw on the projected screen</b></li> </ul>	☞ p.152
<ul style="list-style-type: none"> <li>• <b>Cannot operate a computer from the projected screen after connecting to the computer</b></li> </ul>	☞ p.153
<ul style="list-style-type: none"> <li>• <b>The message "An error occurred in the Easy Interactive Function." is displayed</b></li> </ul>	☞ p.153
<ul style="list-style-type: none"> <li>• <b>Computer's mouse does not work correctly</b></li> </ul>	☞ p.153
<ul style="list-style-type: none"> <li>• <b>The interactive pen does not work</b></li> </ul>	☞ p.154
<ul style="list-style-type: none"> <li>• <b>The response time for the interactive pen is slow (only when projecting USB Display)</b></li> </ul>	☞ p.154
<ul style="list-style-type: none"> <li>• <b>The dot moves automatically or does not move to the next position during calibrating manually</b></li> </ul>	☞ p.155

### Other Problems

<ul style="list-style-type: none"> <li>• <b>No sound can be heard or the sound is faint</b></li> </ul>	☞ p.155
<ul style="list-style-type: none"> <li>• <b>No sound can be heard from the microphone</b></li> </ul>	☞ p.156
<ul style="list-style-type: none"> <li>• <b>There is noise in the audio (only when projecting USB Display)</b></li> </ul>	☞ p.156
<ul style="list-style-type: none"> <li>• <b>The remote control does not work</b></li> </ul>	☞ p.156
<ul style="list-style-type: none"> <li>• <b>I want to change the language for messages and menus</b></li> </ul>	☞ p.157
<ul style="list-style-type: none"> <li>• <b>Mail is not received even if an error occurs with the projector</b></li> </ul>	☞ p.157
<ul style="list-style-type: none"> <li>• <b>Cannot change settings using a web browser</b></li> </ul>	☞ p.158

## Problems Relating to Images

### No Images Appear

Check	Remedy
Did you press the [⏻] power button?	Press the [⏻] power button to turn the power on.
Are all of the indicators off?	The power cord is not connected correctly or power is not being supplied. Connect the projector's power cord correctly. ☛ "Getting Ready to Project" <a href="#">p.44</a> Check the breaker and so on to ensure power is being supplied.
Is A/V Mute active?	Press the [A/V Mute] button on the remote control to cancel A/V Mute. ☛ "Hiding the Image and Sound Temporarily (A/V Mute)" <a href="#">p.93</a>
Are the Configuration menu settings correct?	Reset all of the settings. ☛ <b>Reset - Reset All</b> <a href="#">p.137</a>
Is the image to be projected completely black? (Only when projecting computer images)	Some input images, such as screen savers, may be completely black.
Is the image signal format setting correct? (Only when projecting images from a video source)	Change the setting according to the signal for the connected equipment. ☛ <b>Signal - Video Signal</b> <a href="#">p.120</a>
Is the USB cable connected correctly? (Only when projecting USB Display)	Check that the USB cable is connected correctly. Reconnect it if it is not connected or not connected properly.
Is Windows Media Center displayed in full screen? (Only when projecting using USB Display or network connection)	When Windows Media Center is displayed at full screen, you cannot project using USB Display or network connection. Reduce the screen size.
Is an application using the Windows DirectX function displayed? (Only when projecting using USB Display or network connection)	Applications using the Windows DirectX function may not display images correctly.
Is <b>Monitor Out Port</b> set to <b>Monitor Out</b> ?	When projecting images from the Monitor Out/Computer2 port, set the <b>Monitor Out Port</b> to <b>Computer2</b> from the Configuration menu. ☛ <b>Extended - Operation - Monitor Out Port</b> <a href="#">p.123</a>

### Moving Images Are Not Displayed (only the Moving Image Portion Turns Black)

Check	Remedy
Is the computer's image signal being output to the LCD and the monitor? (Only when projecting images from a laptop computer or a computer with a built-in LCD screen)	Change the image signal from the computer to external output only. Check your computer's documentation, or contact the computer's manufacturer.
Are the contents of the moving image you are trying to project copyright protected?	The projector may not be able to project copyright protected moving images that are being played back on a computer. For more details, see the user's guide supplied with the player.

### Projection Stops Automatically

Check	Remedy
Are <b>Sleep Mode</b> or <b>A/V Mute Timer</b> set to <b>On</b> ?	If any of these are set to <b>On</b> , the power turns off automatically in the following situations. <ul style="list-style-type: none"> <li>• When <b>Sleep Mode</b> is set to <b>On</b>: If no operations are performed for a specified length of time while no image signal is being input.</li> <li>• When <b>A/V Mute Timer</b> is set to <b>On</b>: If approximately 30 minutes has passed since the A/V mute was enabled. To prevent the projector from switching off automatically, make sure each setting is set to Off.</li> </ul> 🖱️ <b>ECO - Sleep Mode, A/V Mute Timer</b> <a href="#">p.135</a>
Is the computer in power-saving mode?	If the computer is in power-saving mode and no operations are performed for a specified period of time, the image may disappear. Perform an operation on the computer to display the image again.

### The Message "Not supported" Is Displayed

Check	Remedy
Is the image signal format setting correct? (Only when projecting images from a video source)	Change the setting according to the signal for the connected equipment. 🖱️ <b>Signal - Video Signal</b> <a href="#">p.120</a>
Do the image signal resolution and refresh rate correspond to the mode? (Only when projecting computer images)	See the documentation supplied with the computer for how to change the image signal resolution and refresh rate output from the computer. 🖱️ "Supported Monitor Displays" <a href="#">p.178</a>

## The Message "No Signal" Is Displayed

Check	Remedy
Are the cables connected correctly?	Check that all the cables required for projection are securely connected. ☛ "Getting Ready to Project" <a href="#">p.44</a>
Is the correct port selected?	Change the image by pressing the [Source Search] button on the remote control or the control panel. ☛ "Automatically Detect Input Signals and Change the Projected Image (Source Search)" <a href="#">p.45</a>
Is the power of the connected computer or video equipment turned on?	Turn the power on for the equipment.
Are the image signals being output to the projector? (Only when projecting images from a laptop computer or a computer with a built-in LCD screen)	If the image signals are only being output to the computer's LCD monitor or accessory monitor, change the output so that the image signals are also output externally. For some computer models, when the image signals are output externally, they no longer appear on the LCD monitor or accessory monitor. If the connection is made while the power of the projector or computer is already turned on, the Fn key (Function key) that changes the computer's image signal to external output may not work. Turn the projector and computer off and then back on again. ☛ "Getting Ready to Project" <a href="#">p.44</a> ☛ Computer's documentation
Is the computer in power-saving mode?	If the computer is in power-saving mode and no operations are performed for a specified period of time, the image may disappear. Perform an operation on the computer to display the image again.

## Images Are Fuzzy, Out of Focus, or Distorted

Check	Remedy
Is the focus adjusted correctly?	Move the focus lever to adjust the focus. ☛ "Correcting the Focus" <a href="#">p.55</a>
Is the projector at the correct distance?	Is it projecting outside of the recommended projection distance range? Setup within the recommended range. ☛ "Screen Size and Projection Distance" <a href="#">p.175</a>
Is the Keystone adjustment value too large?	Lower the projection angle to reduce the amount of Keystone correction. ☛ "Adjusting the Vertical Position of the Image (Models Supplied with the Feet only)" <a href="#">p.54</a>

Check	Remedy
Is the <a href="#">Aspect Ratio</a> set correctly?	You can change the Aspect Ratio of the projected image to suit the type, the ratio of height and width, and the resolution of the input signals. ☛ "Changing the Aspect Ratio of the Projected Image" <a href="#">p.59</a>
Has condensation formed on the lens?	If the projector is suddenly taken from a cold environment to a warm environment, or if sudden ambient temperature changes occur, condensation may form on the surface of the lens, and this may cause the images to appear fuzzy. Set the projector up in the room about one hour before it is used. If condensation forms on the lens, turn the projector off and wait for the condensation to disappear.

## Interference or Distortion Appear in Images

Check	Remedy
Is the image signal format setting correct? (Only when projecting images from a video source)	Change the setting according to the signal for the connected equipment. ☛ <a href="#">Signal - Video Signal p.120</a>
Are the cables connected correctly?	Check that all the cables required for projection are securely connected. ☛ "Connecting Equipment" <a href="#">p.28</a>
Is an extension cable being used?	If an extension cable is used, electrical interference may affect the signals. Use the cables supplied with the projector to check if the cables you are using may be causing the problem.
Is the correct resolution selected? (Only when projecting computer images)	Set the computer so that the signals being output are compatible with the projector. ☛ "Supported Monitor Displays" <a href="#">p.178</a> ☛ Computer's documentation
Are the <a href="#">Sync</a> and <a href="#">Tracking</a> settings adjusted correctly? (Only when projecting computer images)	Press the [Auto] button on the remote control or the [Enter] button on the control panel to perform automatic adjustment. If the images are not adjusted correctly even after performing automatic adjustment, you can also make adjustments from the Configuration menu. ☛ <a href="#">Signal - Tracking, Sync. p.120</a>
Is <b>Transfer layered window</b> selected? (Only when projecting USB Display)	Click <b>All Programs - EPSON Projector - Epson USB Display - Epson USB Display Ver.x.xx Settings</b> , and then clear the <b>Transfer layered window</b> checkbox.

## The Mouse Cursor Flickers (only when Projecting USB Display)

Check	Remedy
Is <b>Make the movement of the mouse pointer smooth.</b> selected?	Click <b>All Programs - EPSON Projector - Epson USB Display - Epson USB Display Ver.x.xx Settings</b> , and then select the <b>Make the movement of the mouse pointer smooth.</b> checkbox. (Windows 2000 is unavailable.) Windows Aero becomes unavailable if this is selected in Windows 7 and Windows Vista.

## The Image Is Truncated (Large) or Small, or the Aspect Is Not Suitable

Check	Remedy
Is a wide-panel computer image being projected? (Only when projecting computer images)	Change the setting according to the signal for the connected equipment. ☛ <b>Signal - Resolution</b> p.120
Is the image still being enlarged by E-Zoom?	Press the [Esc] button on the remote control to cancel E-Zoom. ☛ "Enlarging Part of the Image (E-Zoom)" p.94
Is the display position adjusted correctly?	(Only when projecting analog RGB signals input from the Computer1 or Computer2 port) Press the [Auto] button on the remote control or the [Enter] button on the control panel to adjust the position. You can also adjust the position from the Configuration menu. ☛ <b>Signal - Position</b> p.120
Is the computer set for dual display? (Only when projecting computer images)	If dual display is activated in the <b>Display Properties</b> of the computer's Control Panel, only about half of the image on the computer screen is projected. To display the entire image on the computer screen, turn off the dual display setting. ☛ Computer video driver documentation
Is the correct resolution selected? (Only when projecting computer images)	Set the computer so that the signals being output are compatible with the projector. ☛ "Supported Monitor Displays" p.178 ☛ Computer's documentation
Did you adjust the image position after performing Adjust Zoom or Keystone?	Perform Image Shift to adjust the image position after performing Adjust Zoom or Keystone. ☛ "Adjusting the Position of the Image (Image Shift)" p.53
Is the projection mode correct?	Depending on how the projector is installed, set <b>Projection</b> from one of the following: <b>Front, Front/Upside Down, Rear, Rear/Upside Down.</b> ☛ <b>Extended - Projection</b> p.123 ☛ "Installation Methods" p.25

## Image Colors Are Not Right

Check	Remedy
Do the input signal settings match the signals from the connected device?	Change the following settings according to the signal for the connected equipment. <ul style="list-style-type: none"> <li>• When the image is from a device connected to the Computer1 or Computer2 port.                             <ul style="list-style-type: none"> <li>☛ <b>Signal - Input Signal</b> p.120</li> </ul> </li> <li>• When the image is from a device connected to the Video or S-Video port.                             <ul style="list-style-type: none"> <li>☛ <b>Signal - Video Signal</b> p.120</li> </ul> </li> </ul>
Is the image Brightness adjusted correctly?	Adjust the <b>Brightness</b> setting from the Configuration menu. <ul style="list-style-type: none"> <li>☛ <b>Image - Brightness</b> p.119</li> </ul>
Are the cables connected correctly?	Check that all the cables required for projection are securely connected. <ul style="list-style-type: none"> <li>☛ "Connecting Equipment" p.28</li> </ul>
Is the <u>contrast</u>  adjusted correctly?	Adjust the <b>Contrast</b> setting from the Configuration menu. <ul style="list-style-type: none"> <li>☛ <b>Image - Contrast</b> p.119</li> </ul>
Is color adjustment set to an appropriate value?	Adjust the <b>Color Adjustment</b> setting from the Configuration menu. <ul style="list-style-type: none"> <li>☛ <b>Image - Color Adjustment</b> p.119</li> </ul>
Are the color saturation and tint adjusted correctly? (Only when projecting images from a video source)	Adjust the <b>Color Saturation</b> and <b>Tint</b> settings from the Configuration menu. <ul style="list-style-type: none"> <li>☛ <b>Image - Color Saturation, Tint</b> p.119</li> </ul>

## Images Appear Dark

Check	Remedy
Is the image brightness set correctly?	Adjust the <b>Brightness</b> and <b>Power Consumption</b> settings from the Configuration menu. <ul style="list-style-type: none"> <li>☛ <b>Image - Brightness</b> p.119</li> <li>☛ <b>ECO - Power Consumption</b> p.135</li> </ul>
Is the <u>contrast</u>  adjusted correctly?	Adjust the <b>Contrast</b> setting from the Configuration menu. <ul style="list-style-type: none"> <li>☛ <b>Image - Contrast</b> p.119</li> </ul>
Is it time to replace the lamp?	When the lamp is nearly ready for replacement, the images become darker and the color quality declines. Replace the lamp with a new one. <ul style="list-style-type: none"> <li>☛ "Replacing the Lamp" p.165</li> </ul>
Are you using the projector at a high altitude or in a location subject to high temperatures?	The screen may become dark when using at high altitude or in a location subject to high temperatures. Although you cannot make <b>Power Consumption</b> settings at this time, you can continue to use the projector.

## Problems when Projection Starts

### The Projector Does Not Turn on

Check	Remedy
Did you press the [⏻] power button?	Press the [⏻] power button to turn the power on.
Are all of the indicators off?	The power cord is not connected correctly or power is not being supplied. Disconnect and then reconnect the power cord. ☛ "Getting Ready to Project" <a href="#">p.44</a> Check the breaker and so on to ensure power is being supplied.
Do the indicators turn on and off when the power cord is touched?	There is probably a poor contact in the power cord, or the power cord may be defective. Reinsert the power cord. If this does not solve the problem, stop using the projector, disconnect the power cord from the electrical outlet, and contact your local dealer or the nearest address provided in the Epson Projector Contact List. ☛ <a href="#">Epson Projector Contact List</a>
Is the <b>Control Panel Lock</b> set to <b>Full Lock</b> ?	Press the [⏻] power button on the remote control. If you do not want to use <b>Control Panel Lock</b> , change the setting to <b>Off</b> . ☛ <a href="#">Settings - Control Panel Lock p.122</a>
Is remote control operation restricted?	Check the <b>Remote Receiver</b> from the Configuration menu. ☛ <a href="#">Settings - Remote Receiver p.122</a>

## Problems with the Interactive Features (EB-585Wi/EB-575Wi only)

### Cannot Draw on the Projected Screen

Check	Remedy
Has pen calibration been performed correctly?	Make sure you perform pen calibration when using the interactive pen for the first time so that the projector recognizes the position of the pen correctly. Also, calibrate the system again if you notice any discrepancy in positioning. ☛ "Pen Calibration" <a href="#">p.71</a>
Is <b>Pen Mode</b> set to <b>PC Interactive</b> ?	Set <b>Pen Mode</b> to <b>PC Free Annotation</b> from the Configuration menu. ☛ <a href="#">Extended - Easy Interactive Function - Pen Mode p.126</a>



### Cannot Operate a Computer from the Projected Screen after Connecting to the Computer

Check	Remedy
Is <b>Extended</b> set correctly?	<p>Make the following settings:</p> <ul style="list-style-type: none"> <li>• Set <b>Pen Mode</b> to <b>PC Interactive</b> from the Configuration menu.                             <ul style="list-style-type: none"> <li>☛ <b>Extended - Easy Interactive Function - Pen Mode</b> <a href="#">p.126</a></li> </ul> </li> <li>• Set <b>USB Type B</b> to <b>Easy Interactive Function</b> or <b>USB Display/Easy Interactive Function</b> from the Configuration menu. When using USB Display, set <b>USB Display/Easy Interactive Function</b>.                             <ul style="list-style-type: none"> <li>☛ <b>Extended - USB Type B</b> <a href="#">p.123</a></li> </ul> </li> </ul>
Is the <b>Pen Operation Mode</b> set correctly?	<p>When using interactive pens as you would use a mouse, set the <b>Pen Operation Mode</b> to <b>Two Users/Mouse</b> or <b>One User/Mouse</b> from the Configuration menu.</p> <ul style="list-style-type: none"> <li>☛ <b>Extended - Easy Interactive Function - Pen Operation Mode</b> <a href="#">p.126</a></li> </ul>
Is the USB cable connected correctly?	Check the USB cable connections. You may be able to resolve the problem by disconnecting and then reconnecting the USB cable.
If you are using a notebook computer when the battery power is running low, the USB port may stop working and you might not be able to use USB devices.	Connect the computer to a power source.

### The Message "An error occurred in the Easy Interactive Function." Is Displayed

Check	Remedy
An error has occurred in the interactive features.	<p>Contact the nearest address provided in the Epson Projector Contact List.</p> <ul style="list-style-type: none"> <li>☛ <a href="#">Epson Projector Contact List</a></li> </ul>

### Computer's Mouse Does Not Work Correctly

Check	Remedy
Is the interactive pen placed on the projection screen?	Remove the interactive pen from the projection screen.

### The Interactive Pen Does Not Work

Check	Remedy
There is an obstacle in the signal route between the interactive pen and the projector.	Remove the obstacle. Also, do not block the signal route when standing in front of the projection screen.
The signal is interfering with other things such as a light source that is emitting infrared rays.	Do not use an infrared remote control or infrared microphone in the same room because the interactive pen may malfunction. Switch off the interfering device such as a light source that is emitting infrared rays.
The battery is low.	Press the button on the side of the pen to check the remaining battery power. If the battery light does not turn on, replace the battery. ☛ "Replacing the Battery for the Interactive Pen" <a href="#">p.21</a>
The surrounding area is too bright.	Do not allow strong light to shine on the projected screen or the projector's Easy Interactive Function receiver.
Has pen calibration been performed correctly?	Make sure you perform pen calibration when using the interactive pen for the first time so that the projector recognizes the position of the pen correctly. Also, calibrate the system again if you notice any discrepancy in positioning. ☛ "Pen Calibration" <a href="#">p.71</a>
Are multiple projectors being used in the same room?	When using the interactive pen in the same room as multiple projectors, interference may cause pen operations to become unstable. Connect the optional remote control cable set (ELPKC28). If you do not have a remote control cable set, change the <b>Distance of Projectors</b> setting from the Configuration menu. ☛ "Connecting Multiple Projectors (EB-585Wi/EB-575Wi only)" <a href="#">p.41</a> ☛ <b>Extended - Easy Interactive Function - Advanced Distance of Projectors</b> <a href="#">p.126</a>

### The Response Time for the Interactive Pen Is Slow (only when Projecting USB Display)

Check	Remedy
Is Windows Aero enabled? (Windows 7 and Windows Vista only)	Interactive pen operations may be slow when Windows Aero is enabled. Disable Windows Aero on the computer being used. Click <b>All Programs - EPSON Projector - Epson USB Display - Epson USB Display Ver.x.xx Settings</b> , and then select the <b>Disable Windows Aero and improve the tracking of the interactive pen.</b> checkbox.

## The Dot Moves Automatically or Does Not Move to the Next Position during Calibrating Manually

Check	Remedy
Information from the projection screen is not correctly received due to other things, such as a light source that is emitting infrared rays.	Move the device, such as a light source that is emitting infrared rays, away from the projector, or move the projector away from the device.
Information from the projection screen may not be received correctly if the projector is too close to the screen.	Setup within the recommended projection distance. ☛ "Screen Size and Projection Distance" p.175
The interactive pen is disabled due to unstable conditions in the surrounding area, such as a light source that is emitting infrared rays.	Move the projector or turn off the interfering device, such as a light source that is emitting infrared rays.



## Other Problems

### No Sound Can Be Heard or the Sound Is Faint

Check	Remedy
Check that the audio/video cable is securely attached to both the projector and audio source.	Disconnect the cable from the audio input port, and then reconnect the cable.
Is the projector volume set to the minimum?	Adjust the volume so that sound can be heard. ☛ <b>Settings - Volume</b> p.122 ☛ "Adjusting the Volume" p.57
Is the volume for the computer or from the image source set to the minimum?	Adjust the volume so that sound can be heard.
Is the Mic Input Level set at the maximum?	Lower the Mic Input Level. ☛ <b>Settings - Mic Input Level</b> p.122
Is A/V Mute active?	Press the [A/V Mute] button on the remote control to cancel A/V Mute. ☛ "Hiding the Image and Sound Temporarily (A/V Mute)" p.93
Is the audio cable's specification "No resistance"?	When using a commercially available audio cable, make sure it is labeled "No resistance".
Is it connected with an HDMI cable?	If no audio is output when connecting via an HDMI cable, set the connected equipment to PCM output.
Is <b>Output audio from the projector</b> selected? (Only when projecting USB Display)	Click <b>All Programs - EPSON Projector - Epson USB Display - Epson USB Display Ver.x.xx Settings</b> , and then select the <b>Output audio from the projector</b> checkbox.

Check	Remedy
Is the correct audio input selected?	Check the <b>Audio Output</b> , <b>HDMI1 Audio Output</b> , and <b>HDMI2 Audio Output</b> settings from the Configuration menu.  <a href="#">Extended - A/V Settings p.123</a>



## No Sound Can Be Heard from the Microphone

Check	Remedy
Is the microphone connected correctly?	Disconnect the cable from the Microphone (Mic) port, and then reconnect the cable.  <a href="#">"Connecting a Microphone" p.36</a>
Is the microphone input volume turned down too low?	Adjust the microphone input volume so that sound can be heard.  <a href="#">Settings - Mic Input Level p.122</a>
Are you using a plug-in power type microphone?	The projector does not support plug-in power type microphones. Use a commercially available dynamic microphone.  <a href="#">Settings - Mic Input Level p.122</a>

## There Is Noise in the Audio (only when Projecting USB Display)

Check	Remedy
Is the volume for the computer set to minimum while the projector's volume is set to maximum?	The audio may contain noise if the volume for the computer is set to minimum while the projector's volume is set to maximum. Increase the volume for the computer, and decrease the volume for the projector.  <a href="#">Settings - Volume p.122</a>

## The Remote Control Does Not Work

Check	Remedy
Is the remote control light-emitting area pointing towards the remote receiver on the projector during operation?	Point the remote control towards the remote receiver during operation.  <a href="#">"Remote Control Operating Range" p.20</a>
Is the remote control too far from the projector?	The operating range for the remote control is about 6 m.  <a href="#">"Remote Control Operating Range" p.20</a>
Is direct sunlight or strong light from fluorescent lamps shining onto the remote receiver?	Set the projector up in a location where strong light does not shine onto the remote receiver.  <a href="#">Settings - Remote Receiver p.122</a>

Check	Remedy
Is the correct setting for the <b>Remote Receiver</b> selected?	Check the <b>Remote Receiver</b> from the Configuration menu. ☛ <a href="#">Settings - Remote Receiver p.122</a>
Are the batteries dead or have the batteries been inserted in the wrong direction?	Insert new batteries in the correct direction. ☛ "Replacing the Remote Control Batteries" <a href="#">p.19</a>

## I Want to Change the Language for Messages and Menus

Check	Remedy
Change the language setting.	Adjust the Language setting from the Configuration menu. ☛ <a href="#">Extended - Language p.123</a>

## Mail Is Not Received even if an Error Occurs with the Projector

Check	Remedy
Is <b>Standby Mode</b> set to <b>Communication On</b> ?	To use the Mail Notification function when the projector is in standby, set <b>Communication On in Standby Mode</b> from the Configuration menu. ☛ <a href="#">ECO - Standby Mode p.135</a>
Did a fatal abnormality occur and the projector come to a sudden stop?	When the projector comes to a sudden stop, email cannot be sent. If the abnormal state continues, contact your local dealer or the nearest address provided in the Epson Projector Contact List. ☛ <a href="#">Epson Projector Contact List</a>
Is power being supplied to the projector?	Check that your electrical outlet or power source is functioning correctly.
Is the Mail Notification function set correctly in the Configuration menu?	An error notification email is sent according to the <b>Mail</b> settings in the Configuration menu. Check if it is set correctly. ☛ "Mail Menu" <a href="#">p.133</a>





**Cannot Change Settings Using a Web Browser**

Check	Remedy
Are the user ID and password correct?	Enter "EPSONWEB" as the user ID. This cannot be changed. Enter the user ID even if the password setting is disabled. Enter the password you set in Web Control Password. The default password is "admin".

Check the numbers and then apply the following countermeasures. If you cannot resolve the problem, contact your network administrator, or contact your local dealer or the nearest address provided in the Epson Projector Contact List.

 [Epson Projector Contact List](#)

Event ID	Cause	Remedy
0432 0435	Failed to start EasyMP Network Projection.	Restart the projector.
0434 0482 0484 0485	Network communication is unstable.	Check the network communication status, and reconnect after waiting for a while.
0433	Cannot play transferred images.	Restart EasyMP Network Projection.
0481	Communication was disconnected from the computer.	
0483 04FE	EasyMP Network Projection ended unexpectedly.	Check the network communication status, and then restart the projector.
0479 04FF	A system error occurred in the projector.	Restart the projector.
0891	Cannot find an access point with the same SSID.	Set the computer, the access point, and the projector to the same SSID.
0892	The WPA/WPA2 authentication type does not match.	 <a href="#">Security p.131</a>
0893	The WEP/TKIP/AES encryption type does not match.	
0894	Communication was disconnected because the projector connected to an unauthorized access point.	Contact your network administrator for more information.
0898	Failed to acquire DHCP.	Check that the DHCP server is operating correctly. If you are not using DHCP, turn off the DHCP setting.  <a href="#">Wireless LAN - IP Settings p.130</a>
0899	Other communication errors	If restarting the projector or EasyMP Network Projection does not solve the problem, contact your local dealer or the nearest address provided in the Epson Projector Contact List.  <a href="#">Epson Projector Contact List</a>



# Maintenance

This chapter provides information on maintenance procedures to ensure the best level of performance from the projector for a long time to come.



You should clean the projector if it becomes dirty or if the quality of projected images starts to deteriorate.

## **Caution**

Before cleaning, turn off the projector's power and unplug the power cable. Otherwise, it could cause an electric shock.

## Cleaning the Projector's Surface

Clean the projector's surface by wiping it gently with a soft cloth.

If the projector is particularly dirty, moisten the cloth with water containing a small amount of neutral detergent, and then firmly wring the cloth dry before using it to wipe the projector's surface.

## **Attention**

Do not use volatile substances such as wax, alcohol, or thinner to clean the projector's surface. The quality of the case may change or become discolored.

## Cleaning the Projection Window

Use a commercially available cloth for cleaning glasses to gently wipe the projection window.

## **Warning**

Do not use sprays that contain flammable gas to remove dirt and dust from the lens. The projector may catch fire because of the high temperature of the lamp inside the projector.

## **Attention**

Do not rub the lens with harsh materials or subject the lens to shocks, as it can easily become damaged.

## Cleaning the Obstacle Sensor

Clean the obstacle sensor when the message "For safety purposes remove any obstacles blocking the lens." is displayed along with a warning sound. Use a commercially available cloth for cleaning glasses to gently wipe the obstacle sensor.

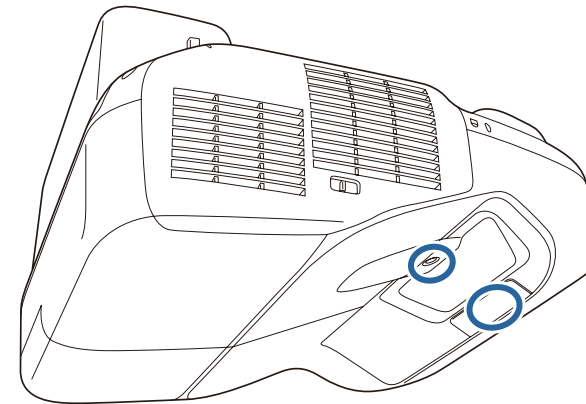

## **Warning**

Do not use sprays that contain flammable gas to remove dirt and dust from the obstacle sensor. The projector may catch fire because of the high temperature of the lamp inside the projector.

### Attention

Do not rub the obstacle sensor with harsh materials or subject the sensor to shocks.

Damage on the surface of the sensor may cause malfunctions.

## Cleaning the Air Filter

Clean the air filter and the air intake vent when the following message is displayed.

"The projector is overheating. Make sure nothing is blocking the air vent, and clean or replace the air filter."

### Attention

- Dust collecting on the air filter may cause the internal temperature of the projector to rise, leading to a malfunction or early deterioration of optical parts. Clean the air filter immediately when the message is displayed.
- Do not rinse the air filter in water. Do not use detergents or solvents.
- When using a brush for cleaning, use one with long soft bristles, and brush it lightly. If it is brushed too strongly, dust will be ground into the air filter and cannot be removed.

- 1 After you turn off the projector's power and the confirmation buzzer beeps twice, disconnect the power cord.

- 2 Open the air filter cover.  
Press the tabs on the air filter cover and open the cover.

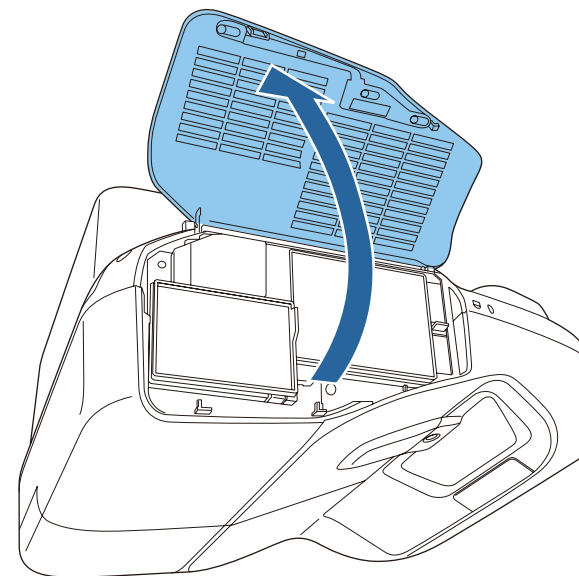
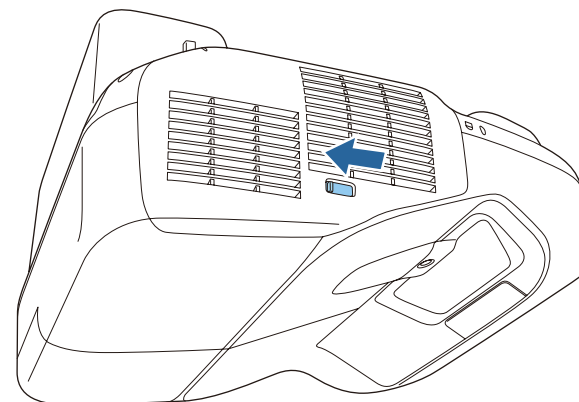

- 3** Remove the air filter.  
Grip the tab in the center of the air filter, and pull the air filter straight out.

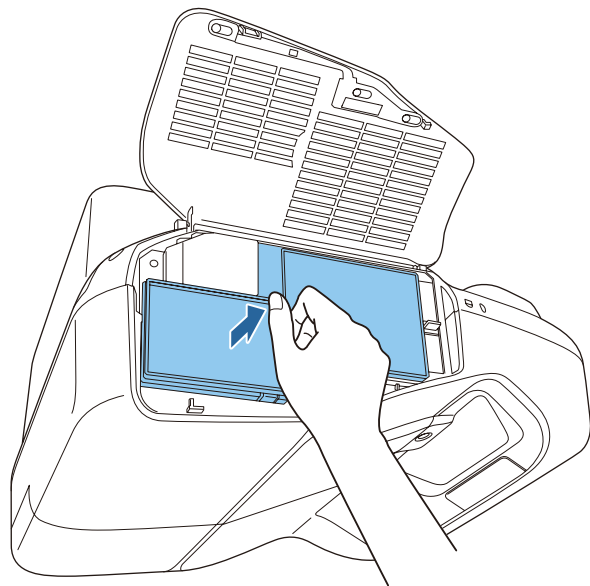

- 4** Remove any dust remaining on the air filter by using a vacuum cleaner from the front.

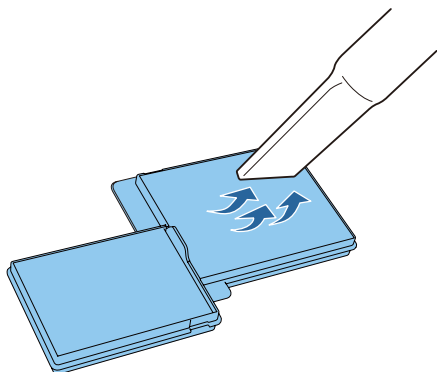

- 5** Replace the air filter.

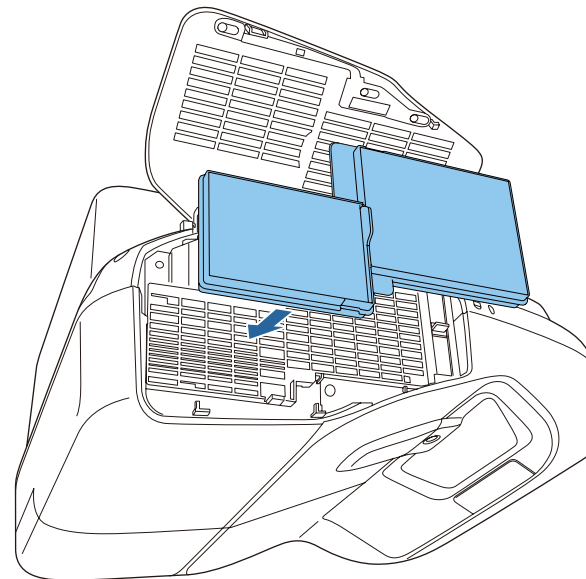

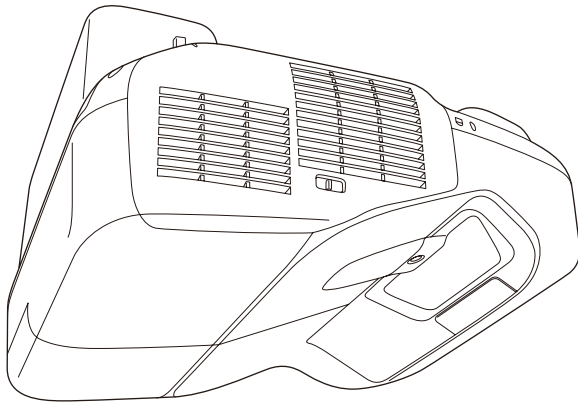
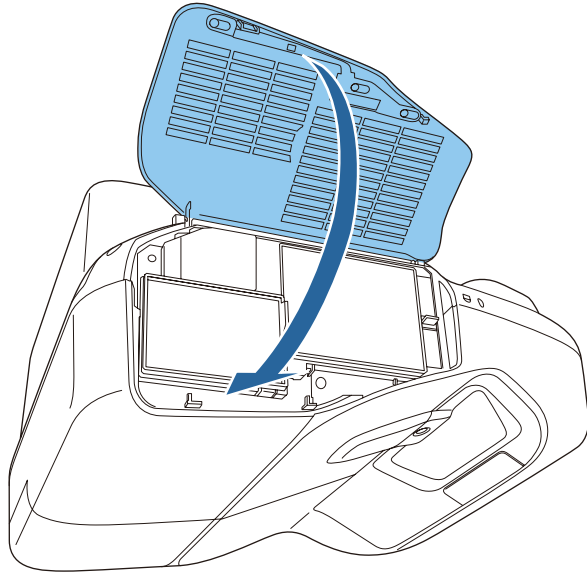
**6** Close the air filter cover.

- If a message is frequently displayed, even after cleaning, it is time to replace the air filter. Replace it with a new air filter.
  - "Replacing the Air Filter" [p.169](#)
- It is recommended that you clean these parts at least once every three months. Clean them more often than this if using the projector in a particularly dusty environment.

This section explains how to replace the lamp and the air filter.

## Replacing the Lamp

### Lamp Replacement Period

It is time to replace the lamp when:

- The following message is displayed.  
"It is time to replace your lamp. Please contact your Epson projector reseller or visit [www.epson.com](http://www.epson.com) to purchase."

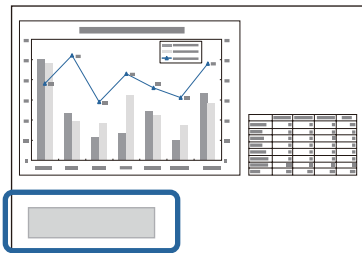

The message is displayed for 30 seconds.

- The power indicator is flashing blue, and the lamp indicator is flashing orange.

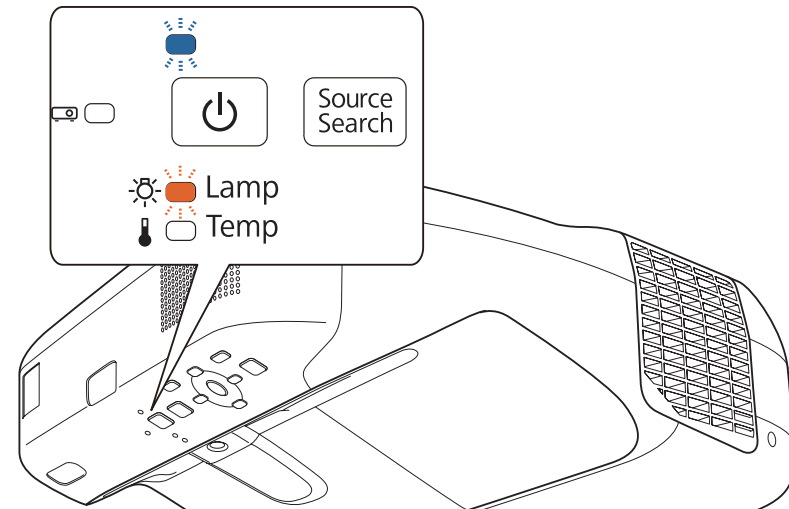

- The projected image gets darker or starts to deteriorate.

## Attention

- The lamp replacement message is set to appear after the following time periods in order to maintain the initial brightness and quality of the projected images.

For EB-585Wi/EB-585W/EB-580:

When **Power Consumption** is set to **Normal**: About 3900 hours

When **Power Consumption** is set to **ECO**: About 5900 hours

For EB-575Wi/EB-575W/EB-570:

When **Power Consumption** is set to **Normal**: About 4900 hours

When **Power Consumption** is set to **ECO**: About 9900 hours

☛ **ECO - Power Consumption** p.135

- If you continue to use the lamp after the replacement period has passed, the possibility that the lamp may blow increases. When the lamp replacement message is displayed, replace the lamp with a new one as soon as possible, even if it is still working.
- Do not repeatedly turn off the power and immediately back on. Turning the power on and off frequently may shorten the lamp's operating life.
- Depending on the individual characteristics of the lamp and the way it has been used, the lamp may become darker or stop working before the message is displayed. You should always have a spare lamp unit ready in case it is needed.
- We recommend the use of genuine Epson option lamps. The use of non-genuine lamps may affect projection quality and safety. Any damage or malfunction caused by the use of non-genuine lamps may not be covered by Epson's warranty.



We recommend that you clean the air filter whenever you replace the lamp.

☛ "Cleaning the Air Filter" p.162

## How to Replace the Lamp

The lamp can be replaced even when the projector is suspended from a wall or ceiling.



### Warning

- When replacing the lamp because it has stopped working, there is a possibility that the lamp may be cracked. When replacing the lamp of a projector that has been installed on a wall or ceiling, assume that the lamp is cracked and stand to the side of the lamp cover, not underneath it. Also, remove the lamp cover gently. Be careful when removing the lamp cover as shards of glass may fall out and could cause an injury. If any shards of glass get into your eyes or mouth, contact your local physician immediately.
- Never disassemble or modify a lamp. If a modified or disassembled lamp is installed in the projector and used, it could cause a fire, electric shock, or an accident.



### Caution

Wait until the lamp has cooled down sufficiently before removing the lamp cover. If the lamp is still hot, burns or other injuries may result. It takes approximately one hour after the power has been turned off for the lamp to sufficiently cool down.

**1**

After you turn off the projector's power and the confirmation buzzer beeps twice, disconnect the power cord.

**2** Wait until the lamp has sufficiently cooled down, and then remove the lamp cover at the top of the projector.

Loosen the lamp cover fixing screw with the screwdriver supplied with the new lamp unit or a cross-head screwdriver. Slide the lamp cover straight forward and remove it.

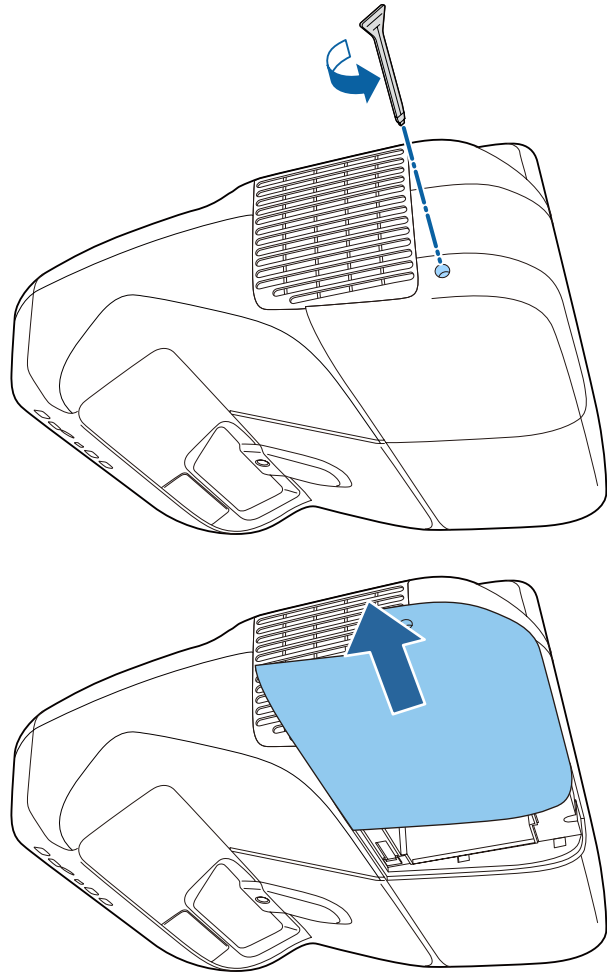

When the projector is mounted on a wall or suspended from a ceiling and you need to replace the lamp, remove the lamp cover carefully and support it with your hand to prevent it from falling.

**3** Loosen the two lamp fixing screws.

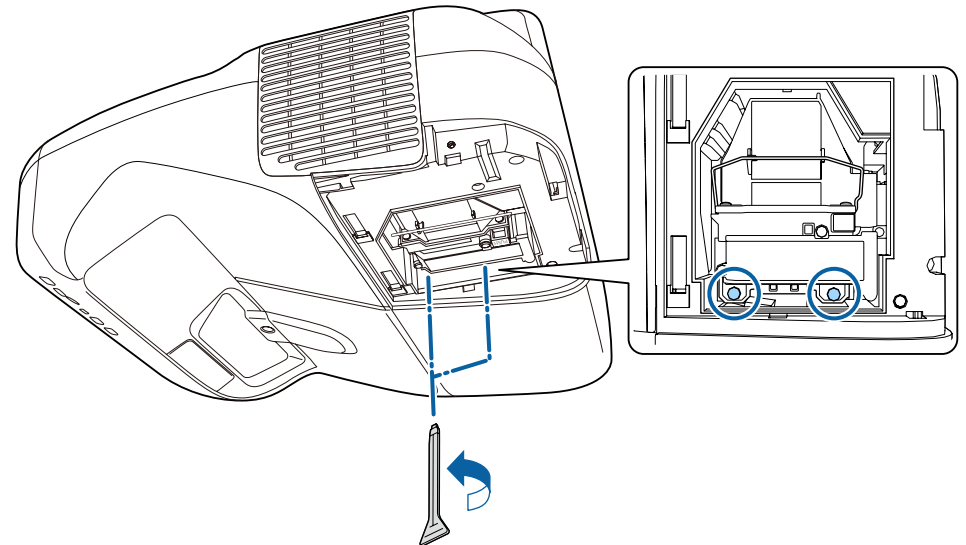

- 4** Remove the old lamp by pulling the handle.  
If the lamp is cracked, replace it with a new lamp, or contact your local dealer for further advice.

 [Epson Projector Contact List](#)

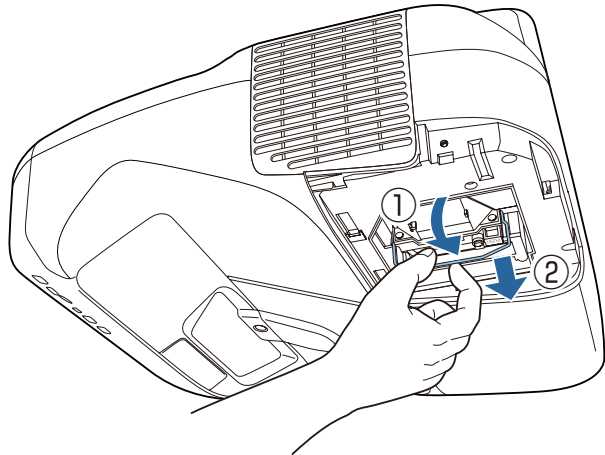

- 5** Install the new lamp.  
Insert the new lamp along the guide rail in the correct direction so that it fits in place, push in firmly, and then press the handle down. Tighten the two lamp fixing screws.

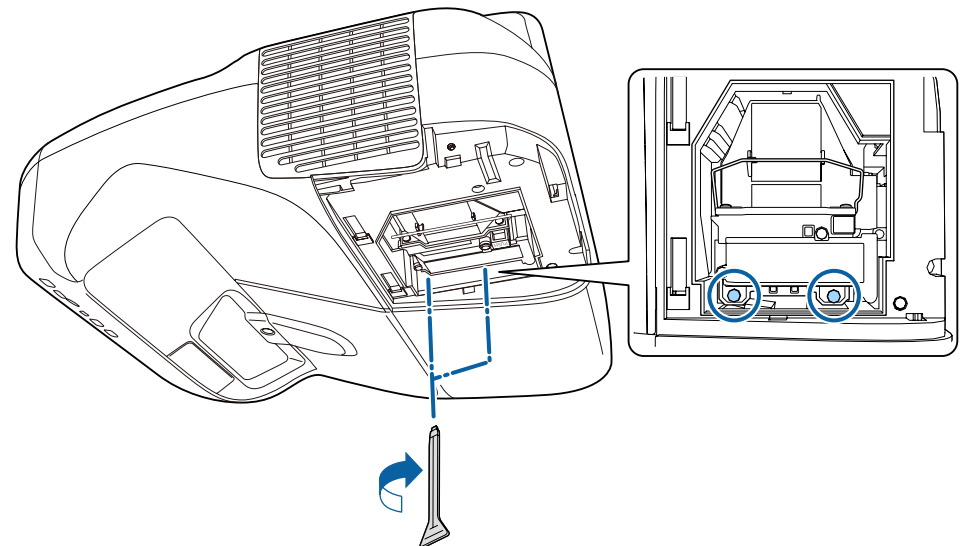
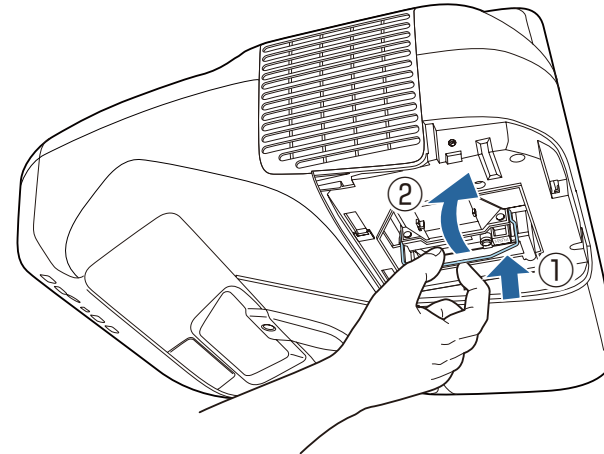



- 6** Attach the lamp cover.

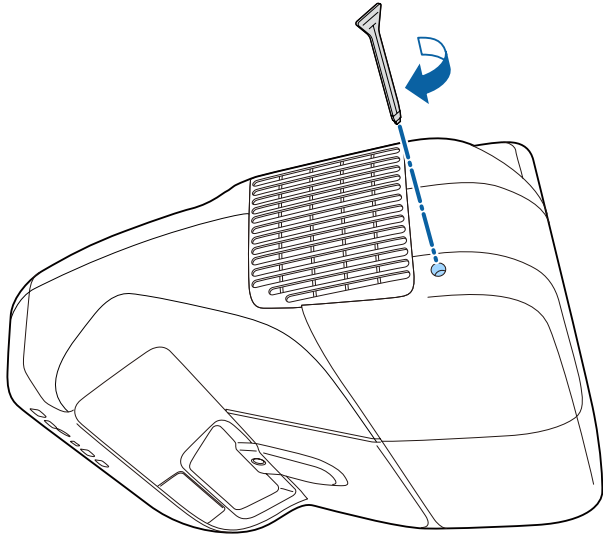

### Attention

- Make sure you install the lamp securely. If the lamp cover is removed, the power turns off automatically as a safety precaution. If the lamp or the lamp cover is not installed correctly, the power does not turn on.
- This product includes a lamp component that contains mercury (Hg). Please consult your local regulations regarding disposal or recycling. Do not dispose of it with normal waste.



Only reset the lamp hours after the lamp has been replaced. Otherwise, the lamp replacement period will not be indicated correctly.

## Replacing the Air Filter

### Air Filter Replacement Period

If the message is displayed frequently even though the air filter has been cleaned, replace the air filter.

### How to Replace the Air Filter

The air filter can be replaced even when the projector is suspended from a wall or ceiling.

**1**

After you turn off the projector's power and the confirmation buzzer beeps twice, disconnect the power cord.

## Resetting the Lamp Hours

The projector records how long the lamp is on and a message and indicator notify you when it is time to replace the lamp. After replacing the lamp, make sure you reset the lamp hours from the Configuration menu.

☛ "Reset Menu" [p.137](#)

- 2** Open the air filter cover.  
Press the tabs on the air filter cover and open the cover.

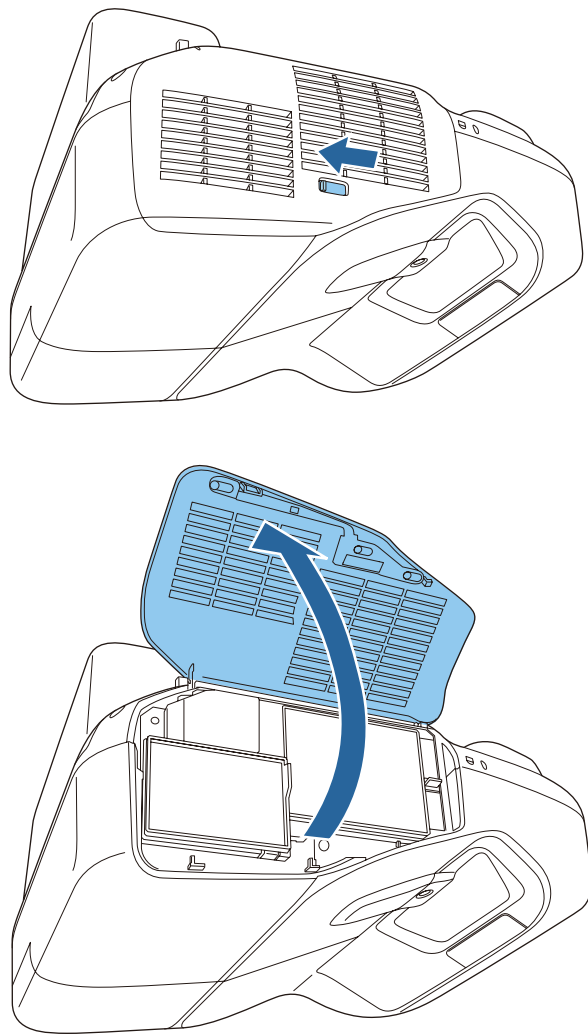

- 3** Remove the air filter.  
Grip the tab in the center of the air filter, and pull the air filter straight out.

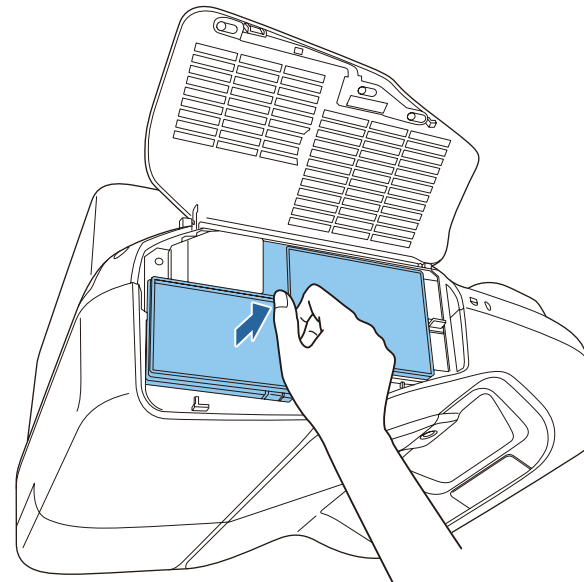

**4** Install the new air filter.

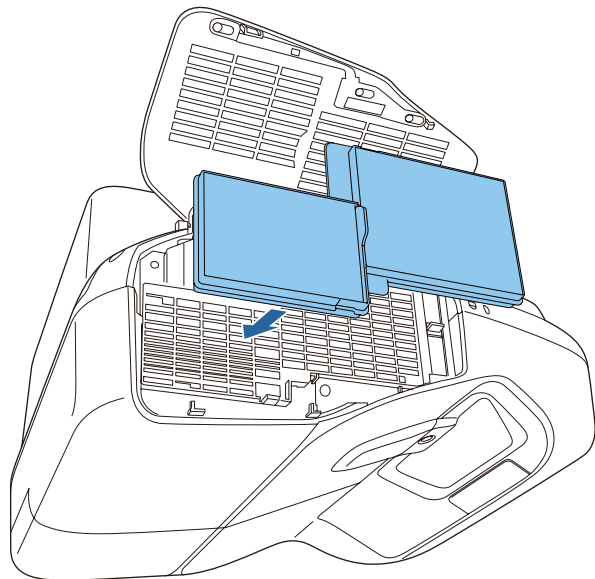

**5** Close the air filter cover.

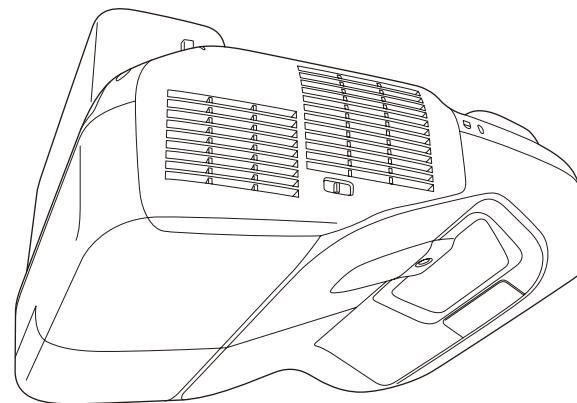
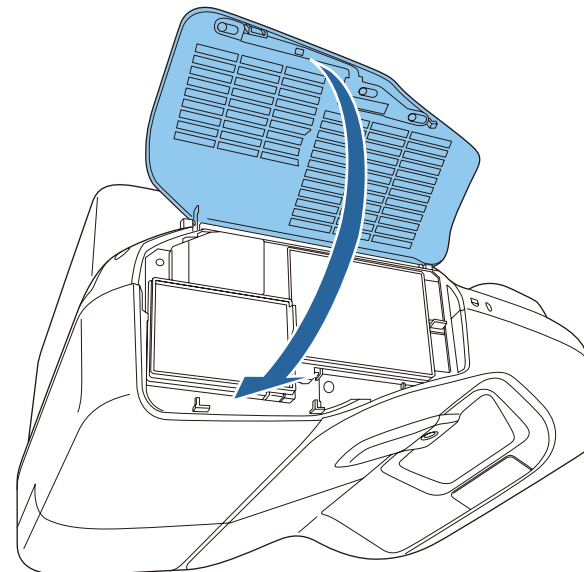



Dispose of used air filters properly in accordance with your local regulations.

Material of the frame part: Polypropylene

Material of the filter part: Polypropylene



# Appendix

The following optional accessories and consumables are available. Please purchase these products as and when needed. The following list of optional accessories and consumables is current as of: January 2014. Details of accessories are subject to change without notice.

## Optional Accessories

### Document Camera ELPDC06/ELPDC11/ELPDC12/ELPDC20

Use when projecting images such as books, OHP documents, or slides.

### Computer cable ELPKC02

(1.8 m - for mini D-Sub15-pin/mini D-Sub 15pin)

### Computer cable ELPKC09

(3 m - for mini D-Sub15-pin/mini D-Sub 15pin)

### Computer cable ELPKC10

(20 m - for mini D-Sub15-pin/mini D-Sub 15pin)

### Component video cable ELPKC19

(3 m - for mini D-Sub 15-pin/RCA male×3)

Use to connect a [Component Video](#) source.

### Wireless LAN unit ELPAP07

Use when connecting the projector to a computer wirelessly and projecting.

### Quick Wireless Connection USB Key ELPAP09

Use when you want to establish one-to-one connection between the projector and a computer with Windows installed.

### Interactive Table Mount ELPMB29

Use when installing the projector on a table.

### Ceiling mount\* ELPMB23

Use when installing the projector on a ceiling.

### Attachment plate ELPPT06

Use when attaching the ceiling mount to the projector.

### Easy Interactive Pen ELPPN04A/ELPPN04B

Pens for the interactive features. You cannot use interactive pens with the same model number at the same time.

### Interactive Pen Extension ELPPE01

Attach to the interactive pen to extend the pen and use it as a pointer.

### Replacement Pen Tips ELPPS02

Replacement pen tips for the interactive pen.

### USB extension cable ELPKC31

Connect to a USB cable if the cable is too short.

### Interface box ELPCB02

When the projector is mounted on a wall or suspended from a ceiling, install the remote control to operate the projector at hand.

### Remote control cable set ELPKC28

Cables to connect multiple projectors that support the interactive features.

\* Special expertise is required to suspend the projector. Contact your local dealer or the nearest address provided in the Epson Projector Contact List.

 [Epson Projector Contact List](#)

## Consumables

### Lamp unit

- ELPLP80 (for EB-585Wi/EB-585W/EB-580)
- ELPLP79 (for EB-575Wi/EB-575W/EB-570)

Use as a replacement for a used lamp.

### Air Filter ELPAF40

Use as a replacement for a used air filter.

## Projection Distance (for EB-585Wi/EB-585W/ EB-575Wi/EB-575W)

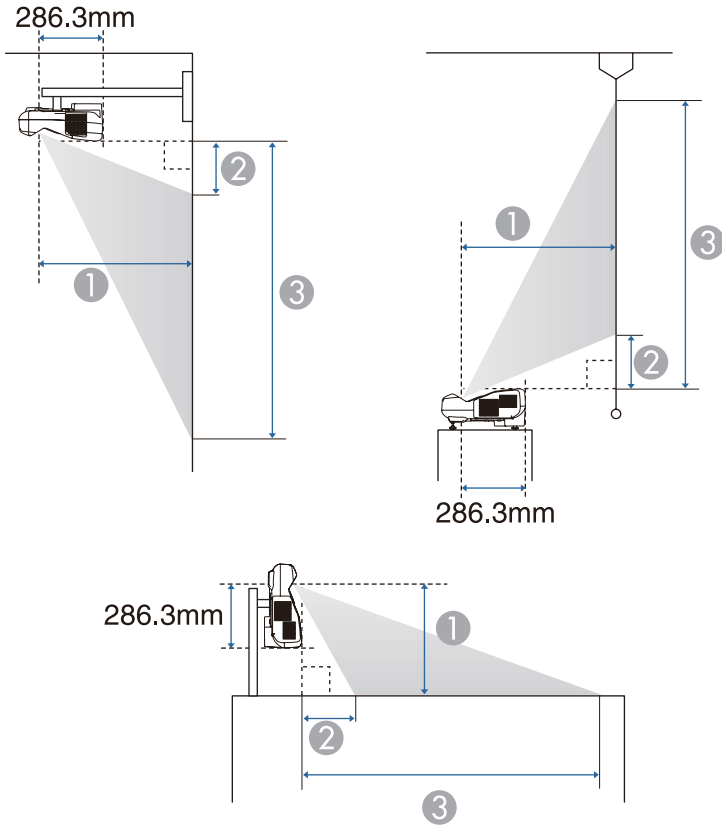

① Projection distance

② The distance between the projector and the top of the screen (when mounting on a wall or ceiling, or installing vertically)  
The distance between the projector and the bottom of the screen (when placing on a surface such as a desk)

③ The distance between the projector and the bottom of the screen (when mounting on a wall or ceiling, or installing vertically)  
The distance between the projector and the top of the screen (when placing on a surface such as a desk)

Unit: cm

16:10 Screen Size		①	②	③
		Minimum (Wide) to Maximum (Tele)	Minimum (Wide)	Minimum (Wide)
60"	129x81	34.8 - 47.9	9	89.8
70"	151x94	41 - 56.2	11.7	105.9
80"	172x108	47.2 - 60	14.4	122
90"	194x121	53.4 - 60	17	138.2
100"	215x135	59.6 - 60	19.7	154.3

Unit: cm

4:3 Screen Size		①	②	③
		Minimum (Wide) to Maximum (Tele)	Minimum (Wide)	Minimum (Wide)
53"	108x81	34.8 - 47.9	9	89.8
60"	122x91	39.7 - 54.5	11.1	102.6
70"	142x107	46.8 - 60	14.1	120.8
80"	163x122	53.8 - 60	17.2	139.1
88"	179x134	59.4 - 60	19.6	153.7

Unit: cm

16:9 Screen Size		①	②	③
		Minimum (Wide) to Maximum (Tele)	Minimum (Wide)	Minimum (Wide)
59"	131x74	35.2 - 48.4	13.3	86.7

16:9 Screen Size		①	②	③
		Minimum (Wide) to Maximum (Tele)	Minimum (Wide)	Minimum (Wide)
60"	133x75	35.9 - 49.2	13.6	88.3
70"	155x87	42.2 - 57.9	17	104.2
80"	177x100	48.6 - 60	20.5	120.1
90"	199x112	55 - 60	23.9	136
97"	215x121	59.5 - 60	26.3	147.1

## Projection Distance (for EB-580/EB-570)

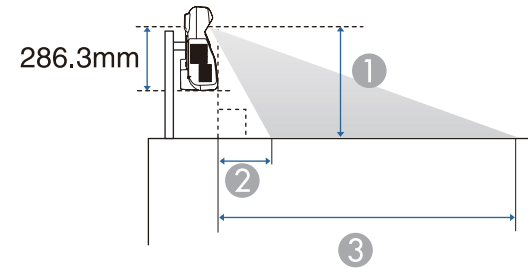
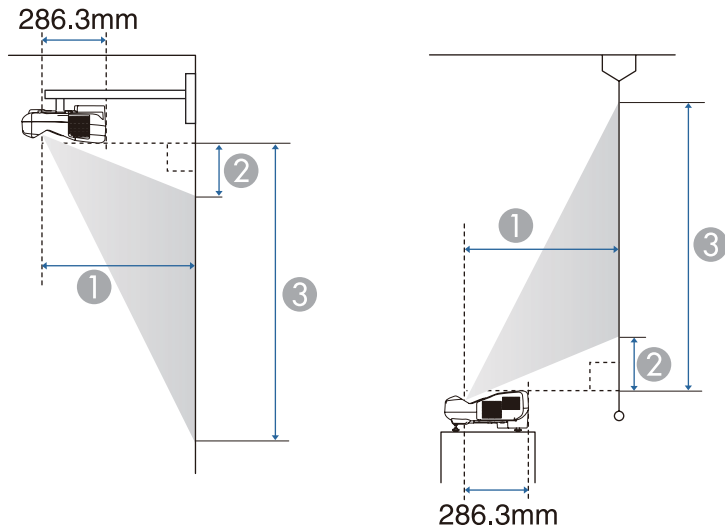

- ① Projection distance
- ② The distance between the projector and the top of the screen (when mounting on a wall or ceiling, or installing vertically)  
The distance between the projector and the bottom of the screen (when placing on a surface such as a desk)
- ③ The distance between the projector and the bottom of the screen (when mounting on a wall or ceiling, or installing vertically)  
The distance between the projector and the top of the screen (when placing on a surface such as a desk)

Unit: cm

4:3 Screen Size		①	②	③
		Minimum (Wide) to Maximum (Tele)	Minimum (Wide)	Minimum (Wide)
56"	114x85	34.8 - 47.9	6.8	92.1
60"	122x91	37.5 - 51.5	7.7	99.2
70"	142x107	44.2 - 60	10.2	116.9
80"	163x122	50.8 - 60	12.7	134.6
90"	183x137	57.5 - 60	15.1	152.3
93"	189x142	59.5 - 60	15.9	157.6





Unit: cm

16:9 Screen Size		①	②	③
		Minimum (Wide) to Maximum (Tele)	Minimum (Wide)	Minimum (Wide)
52"	115x65	35.3 - 48.5	17.7	82.5
60"	133x75	41.1 - 56.3	21.5	96.2
70"	155x87	48.3 - 60	26.3	113.4
80"	177x100	55.6 - 60	31	130.6
85"	188x106	59.2 - 60	33.4	139.2

## Supported Resolutions

### Computer Signals (Analog RGB)

Signal	Refresh Rate (Hz)	Resolution (dots)
VGA	60/72/75/85	640x480
SVGA	56/60/72/75/85	800x600
XGA	60/70/75/85	1024x768
WXGA	60	1280x768
	60	1366x768
	60/75/85	1280x800
WXGA+	60/75/85	1440x900
WXGA++	60	1600x900
SXGA	70/75/85	1152x864
	60/75/85	1280x1024
	60/75/85	1280x960
SXGA+	60/75	1400x1050
WSXGA+*1, 2	60	1680x1050
UXGA	60	1600x1200
MAC13"	67	640x480
MAC16"	75	832x624
MAC19"	75	1024x768
	59	1024x768

Signal	Refresh Rate (Hz)	Resolution (dots)
MAC21"	75	1152x870

\*1 EB-585Wi/EB-585W/EB-575Wi/EB-575W only

\*2 Only compatible when **Wide** is selected as the **Resolution** from the Configuration menu.

Images may also be projected when signals other than the above are input. However, some functions may be limited.

### Component Video

Signal	Refresh Rate (Hz)	Resolution (dots)
SDTV (480i)	60	720x480
SDTV (576i)	50	720x576
SDTV (480p)	60	720x480
SDTV (576p)	50	720x576
HDTV (720p)	50/60	1280x720
HDTV (1080i)	50/60	1920x1080

### Composite Video

Signal	Refresh Rate (Hz)	Resolution (dots)
TV (NTSC)	60	720x480
TV (SECAM)	50	720x576
TV (PAL)	50/60	720x576

### HDMI Input Signal

Signal	Refresh Rate (Hz)	Resolution (dots)
VGA	60	640x480

Signal	Refresh Rate (Hz)	Resolution (dots)
SVGA	60	800x600
XGA	60	1024x768
WXGA	60	1280x800
	60	1366x768
WXGA+	60	1440x900
WXGA++	60	1600x900
WSXGA+*	60	1680x1050
SXGA	60	1280x960
	60	1280x1024
SXGA+	60	1400x1050
UXGA	60	1600x1200
SDTV (480i/480p)	60	720x480
SDTV (576i/576p)	50	720x576
HDTV (720p)	50/60	1280x720
HDTV (1080i)	50/60	1920x1080
HDTV (1080p)	24/30/50/60	1920x1080

\* EB-585Wi/EB-585W/EB-575Wi/EB-575W only

### MHL Input Signal

Signal	Refresh Rate (Hz)	Resolution (dots)
VGA	60	640x480
SDTV (480i/480p)	60	720x480
SDTV (576i/576p)	50	720x576
HDTV (720p)	50/60	1280x720
HDTV (1080i)	50/60	1920x1080
HDTV (1080p)	24/30	1920x1080

## Projector General Specifications

<b>Product name</b>		EB-585Wi	EB-585W
<b>Dimensions</b>	367 (W) x 155 (H) x 375 (D) mm (not including raised section)		
<b>LCD panel size</b>	0.59" Wide		
<b>Display method</b>	Polysilicon TFT active matrix		
<b>Resolution</b>	1,024,000 WXGA (1280 (W) x 800 (H) dots)x 3		
<b>Focus adjustment</b>	Manual		
<b>Zoom adjustment</b>	Digital (1-1.35)		
<b>Lamp</b>	UHE lamp, 245 W Model No.: ELPLP80		
<b>Max. audio output</b>	16 W		
<b>Speaker</b>	1		
<b>Power supply</b>	100-240V AC±10% 50/60Hz 3.8-1.7A		
<b>Power consumption</b>	<b>100 to 120 V area</b>	Operating: 376 W Standby power consumption (Communication On): 4.3 W Standby power consumption (Communication Off): 0.33 W	
	<b>220 to 240 V area</b>	Operating: 358 W Standby power consumption (Communication On): 4.3 W Standby power consumption (Communication Off): 0.44 W	
<b>Operating altitude</b>	Altitude 0 to 3000 m		
<b>Operating temperature</b>	+5 to +35°C (No condensation) (Altitude 0 to 2,286 m) +5 to +30°C (No condensation) (Altitude 2,287 to 3,000 m)		
<b>Storage temperature</b>	-10 to +60°C (No condensation)		
<b>Mass</b>		Approx. 5.5 kg	Approx. 5.3 kg

<b>Product name</b>		EB-575Wi	EB-575W	EB-580	EB-570
<b>Dimensions</b>		367 (W) x 155 (H) x 375 (D) mm (not including raised section)			
<b>LCD panel size</b>		0.59" Wide		0.55"	
<b>Display method</b>		Polysilicon TFT active matrix			
<b>Resolution</b>		1,024,000 WXGA (1280 (W)x 800 (H) dots)x 3		786,432 XGA (1024 (W) x 768 (H) dots)x 3	
<b>Focus adjustment</b>		Manual			
<b>Zoom adjustment</b>		Digital (1-1.35)			
<b>Lamp</b>		UHE lamp, 215 W Model No.: ELPLP79		UHE lamp, 245 W Model No.: ELPLP80	UHE lamp, 215 W Model No.: ELPLP79
<b>Max. audio output</b>		16 W			
<b>Speaker</b>		1			
<b>Power supply</b>		100-240V AC±10% 50/60Hz 3.4-1.5A		100-240V AC±10% 50/60Hz 3.8-1.7A	100-240V AC±10% 50/60Hz 3.4-1.5A
<b>Power consumption</b>	<b>100 to 120 V area</b>	Operating: 333 W Standby power consumption (Communication On): 4.3 W Standby power consumption (Communication Off): 0.33 W		Operating: 376 W Standby power consumption (Communication On): 4.3 W Standby power consumption (Communication Off): 0.33 W	Operating: 333 W Standby power consumption (Communication On): 4.3 W Standby power consumption (Communication Off): 0.33 W
	<b>220 to 240 V area</b>	Operating: 318 W Standby power consumption (Communication On): 4.3 W Standby power consumption (Communication Off): 0.44 W		Operating: 358 W Standby power consumption (Communication On): 4.3 W Standby power consumption (Communication Off): 0.44 W	Operating: 318 W Standby power consumption (Communication On): 4.3 W Standby power consumption (Communication Off): 0.44 W
<b>Operating altitude</b>		Altitude 0 to 3000 m			
<b>Operating temperature</b>		+5 to +35°C (No condensation) (Altitude 0 to 2286 m) +5 to +30°C (No condensation) (Altitude 2,287 to 3,000 m)			
<b>Storage temperature</b>		-10 to +60°C (No condensation)			
<b>Mass</b>		Approx. 5.5 kg		Approx. 5.3 kg	

<b>Connectors</b>	<b>Computer1 port</b>	<b>1</b>	Mini D-Sub 15-pin (female)
	<b>Computer2 input/Monitor Out ports</b>	<b>1</b>	Mini D-Sub 15-pin (female)
	<b>Video port</b>	<b>1</b>	RCA pin jack
	<b>S-Video port</b>	<b>1</b>	Mini DIN 4-pin
	<b>Audio1 port</b>	<b>1</b>	Stereo mini pin jack
	<b>Audio2 port</b>	<b>1</b>	Stereo mini pin jack
	<b>Audio port</b>	<b>1</b>	Stereo mini pin jack
	<b>Mic port</b>	<b>1</b>	Stereo mini pin jack
	<b>Audio Out port</b>	<b>1</b>	Stereo mini pin jack
	<b>HDMI1/MHL input port</b>	<b>1</b>	HDMI (Audio is only supported by PCM)
	<b>HDMI2 port</b>	<b>1</b>	HDMI (Audio is only supported by PCM)
	<b>USB-A port*</b>	<b>1</b>	USB connector (Type A)
	<b>USB-B port*</b>	<b>1</b>	USB connector (Type B)
	<b>USB port (for Wireless LAN unit)</b>	<b>1</b>	USB connector (Type A)
	<b>LAN port</b>	<b>1</b>	RJ-45
	<b>RS-232C port</b>	<b>1</b>	Mini D-Sub 9-pin (male)
<b>SYNC port</b>	<b>2</b>	Stereo mini pin jack	

\* Supports USB 2.0. However, the operation of all USB compatible devices is not guaranteed.

This product is also designed for IT power distribution system with phase-to-phase voltage 230V.

Angle of tilt

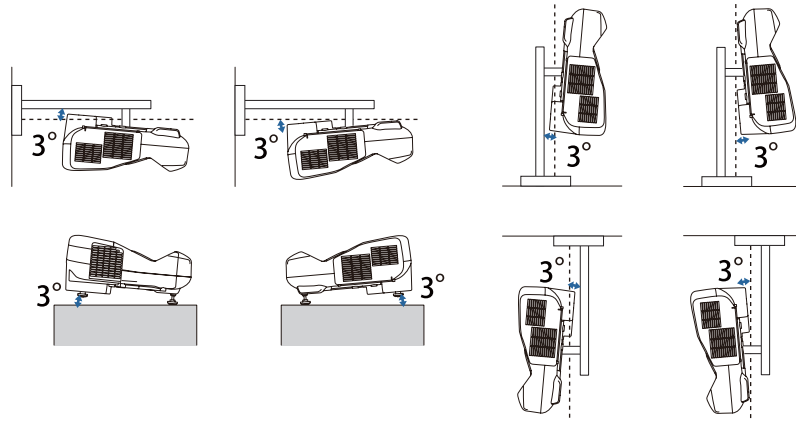

If you use the projector tilted at an angle of more than 3° it could be damaged and cause an accident.

**DECLARATION of CONFORMITY**

According to 47CFR, Part 2 and 15

Class B Personal Computers and Peripherals; and/or  
CPU Boards and Power Supplies used with Class B Personal Computers

We: Epson America, Inc.  
Located at: 3840 Kilroy Airport Way  
MS: 3-13  
Long Beach, CA 90806  
Tel: 562-981-3840

Declare under sole responsibility that the product identified herein, complies with 47CFR Part 2 and 15 of the FCC rules as a Class B digital device. Each product marketed, is identical to the representative unit tested and found to be compliant with the standards. Records maintained continue to reflect the equipment being produced can be expected to be within the variation accepted, due to quantity production and testing on a statistical basis as required by 47CFR 2.909. Operation is subject to the following two conditions : (1) this device may not cause harmful interference, and (2) this device must accept any interference received, including interference that may cause undesired operation.

Trade Name: EPSON  
Type of Product: LCD Projector  
Model: H598C/H599C/H600C/H601C/H602C/H603C/  
H604C/H605C

**FCC Compliance Statement  
For United States Users**

This equipment has been tested and found to comply with the limits for a Class B digital device, pursuant to Part 15 of the FCC Rules. These limits are designed to provide reasonable protection against harmful interference in a residential installation. This equipment generates, uses, and can radiate radio frequency energy and, if not installed and used in accordance with the instructions, may cause harmful interference to radio communications. However, there is no guarantee that interference will not occur in a particular installation. If this equipment does cause interference to radio and television reception, which can be determined by turning the equipment off and on, the user is encouraged to try to correct the interference by one or more of the following measures.

- Reorient or relocate the receiving antenna.
- Increase the separation between the equipment and receiver.
- Connect the equipment into an outlet on a circuit different from that to which the receiver is connected.
- Consult the dealer or an experienced radio/TV technician for help.

**WARNING**

The connection of a non-shielded equipment interface cable to this equipment will invalidate the FCC Certification or Declaration of this device and may cause interference levels which exceed the limits established by the FCC for this equipment. It is the responsibility of the user to obtain and use a shielded equipment interface cable with this device. If this equipment has more than one interface connector, do not leave cables connected to unused interfaces. Changes or modifications not expressly approved by the manufacturer could void the user's authority to operate the equipment.





## FCC Statement for Verification

This device complies with Part 15 of the FCC Rules. Operation is subject to the following two conditions:(1) this device may not cause harmful interference, and (2) this device must accept any interference received, including interference that may cause undesired operation.

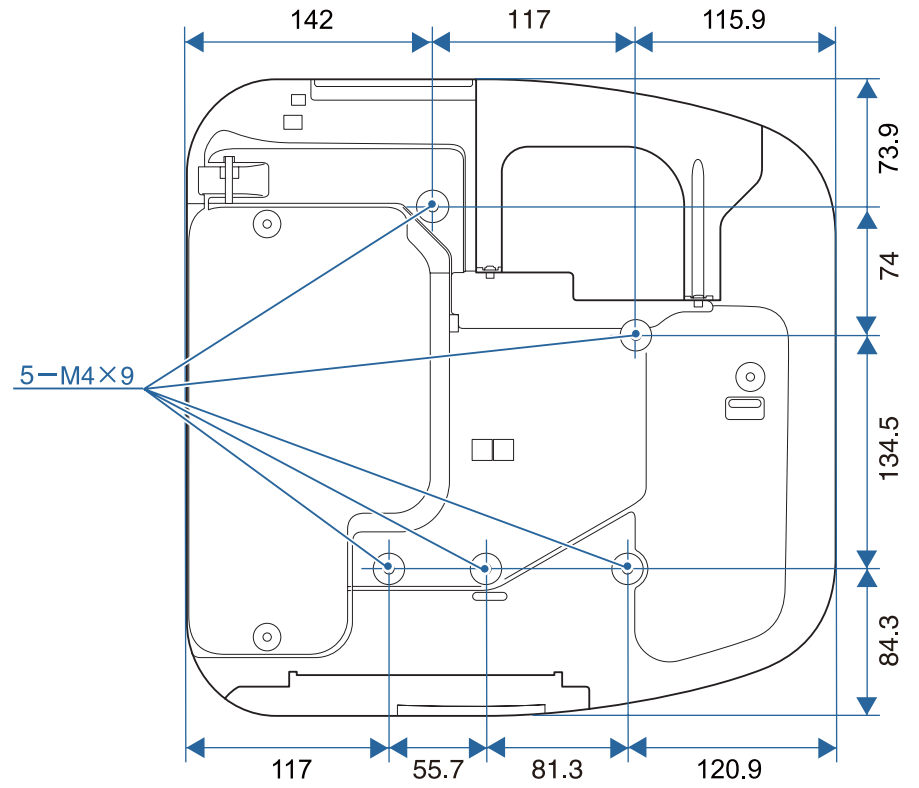
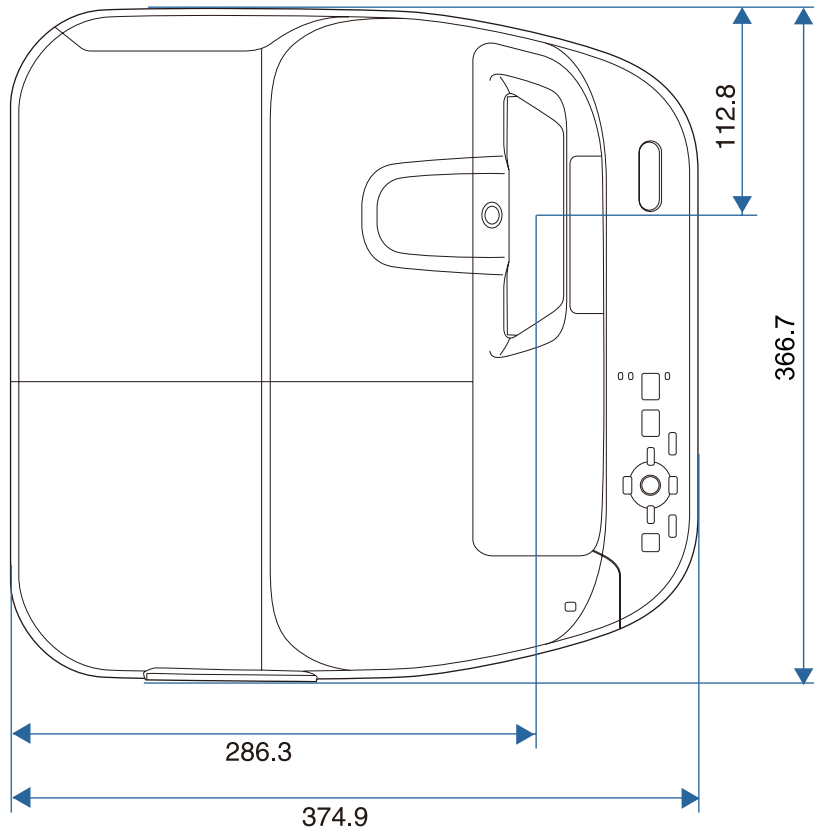

Units: mm

Without feet

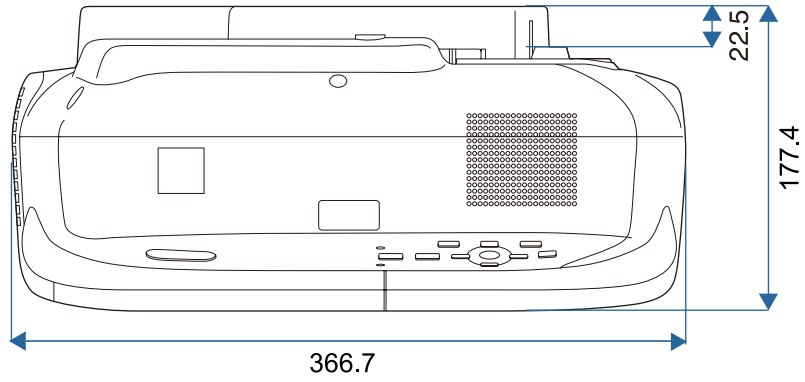

With feet

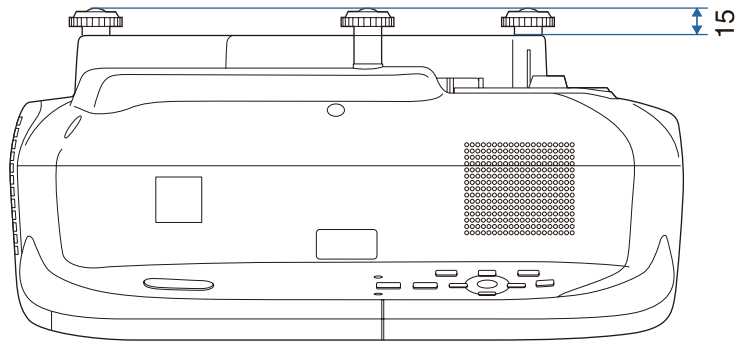

Units: mm

This section briefly explains the difficult terms that are not explained in the text of this guide. For details, refer to other commercially available publications.

<b>Ad hoc mode</b>	A method of wireless LAN connection that communicates with wireless LAN clients without using an access point.
<b>AMX Device Discovery</b>	AMX Device Discovery is a technology developed by AMX to facilitate AMX control systems for easy operation of the target equipment. Epson have implemented this protocol technology, and have provided a setting to enable the protocol function (ON). See the AMX Web site for more details. URL <a href="http://www.amx.com/">http://www.amx.com/</a>
<b>Aspect Ratio</b>	The ratio between an image's length and its height. Screens with a horizontal:vertical ratio of 16:9, such as HDTV screens, are known as wide screens. SDTV and general computer displays have an aspect ratio of 4:3.
<b>Component Video</b>	A method that separates the video signal into a luminance component (Y), and a blue minus luminance (Cb or Pb) and a red minus luminance (Cr or Pr).
<b>Composite video</b>	A method that combines the video signal into a luminance component and a color component for transmission down a single cable.
<b>Contrast</b>	The relative brightness of the light and dark areas of an image can be increased or decreased to make text and graphics stand out more clearly, or to make them appear softer. Adjusting this particular property of an image is called "contrast adjustment".
<b>DHCP</b>	An abbreviation of Dynamic Host Configuration Protocol, this protocol automatically assigns an <a href="#">IP address</a> to equipment connected to a network.
<b>Gateway Address</b>	This is a server (router) for communicating across a network (subnet) divided according to <a href="#">subnet mask</a> .
<b>HDCP</b>	HDCP is an abbreviation for High-bandwidth Digital Content Protection. It is used to prevent illegal copying and protect copyrights by encrypting digital signals sent over DVI and HDMI ports. Because the HDMI port on this projector supports HDCP, it can project digital images protected by HDCP technology. However, the projector may not be able to project images protected with updated or revised versions of HDCP encryption.
<b>HDTV</b>	An abbreviation for High-Definition Television that refers to high-definition systems which satisfy the following conditions. <ul style="list-style-type: none"> <li>• Vertical resolution of 720p or 1080i or greater (p = <a href="#">Progressive</a>, i = <a href="#">Interlace</a>)</li> <li>• Screen <a href="#">aspect ratio</a> of 16:9</li> </ul>
<b>Infrastructure mode</b>	A method for wireless LAN connection in which devices communicate through access points.
<b>Interlace</b>	Transmits information needed to create one screen by sending every other line, starting from the top of the image and working down to the bottom. Images are more likely to flicker because one frame is displayed every other line.
<b>IP Address</b>	A number to identify a computer connected to a network.
<b>MHL</b>	An abbreviation for Mobile High-definition Link, a standard for connection interfaces aimed at mobile devices such as smartphones and tablets. Images can be transferred at high quality and at high speeds without compressing the digital signal, and also charges connected devices.
<b>Progressive</b>	Projects information to create one screen at a time, displaying the image for one frame. Even though the number of scan lines is the same, the amount of flicker in images decreases because the volume of information has doubled compared with an interlace system.

<b>Refresh Rate</b>	The light-emitting element of a display maintains the same luminosity and color for an extremely short time. Because of this, the image must be scanned many times per second to refresh the light-emitting element. The number of refresh operations per second is called the Refresh rate and is expressed in hertz (Hz).
<b>SDTV</b>	An abbreviation for Standard Definition Television that refers to standard television systems which do not satisfy the conditions for <a href="#">HDTV</a> ▶ High-Definition Television.
<b>SNMP</b>	An abbreviation for Simple Network Management Protocol, which is the protocol for monitoring and controlling devices such as routers and computers connected to a TCP/IP network.
<b>sRGB</b>	An international standard for color intervals that was formulated so that colors that are reproduced by video equipment can be handled easily by computer operating systems (OS) and the Internet. If the connected source has an sRGB mode, set both the projector and the connected signal source to sRGB.
<b>SSID</b>	SSID is identification data for connecting to another device on a wireless LAN. Wireless communication is possible between devices with the same SSID.
<b>Subnet Mask</b>	This is a numerical value that defines the number of bits used for the network address on a divided network (subnet) from the IP address.
<b>SVGA</b>	A screen size standard with a resolution of 800 (horizontal) x 600 (vertical) dots.
<b>S-Video</b>	A method that separates the video signal into a luminance component (Y) and a color component (C).
<b>SXGA</b>	A screen size standard with a resolution of 1,280 (horizontal) x 1,024 (vertical) dots.
<b>Sync.</b>	The signals output from computers have a specific frequency. If the projector frequency does not match this frequency, the resulting images are not of a good quality. The process of matching the phases of these signals (the relative position of the crests and the troughs in the signal) is called Synchronization. If the signals are not synchronized, flickering, blurriness, and horizontal interference occur.
<b>Tracking</b>	The signals output from computers have a specific frequency. If the projector frequency does not match this frequency, the resulting images are not of a good quality. The process of matching the frequency of these signals (the number of crests in the signal) is called Tracking. If tracking is not carried out correctly, wide vertical stripes appear in the signal.
<b>Trap IP Address</b>	This is the <a href="#">IP address</a> ▶ for the destination computer used for error notification in SNMP.
<b>VGA</b>	A screen size standard with a resolution of 640 (horizontal) x 480 (vertical) dots.
<b>XGA</b>	A screen size standard with a resolution of 1,024 (horizontal) x 768 (vertical) dots.

All rights reserved. No part of this publication may be reproduced, stored in a retrieval system, or transmitted in any form or by any means, electronic, mechanical, photocopying, recording, or otherwise, without the prior written permission of Seiko Epson Corporation. No patent liability is assumed with respect to the use of the information contained herein. Neither is any liability assumed for damages resulting from the use of the information contained herein.

Neither Seiko Epson Corporation nor its affiliates shall be liable to the purchaser of this product or third parties for damages, losses, costs, or expenses incurred by the purchaser or third parties as a result of: accident, misuse, or abuse of this product or unauthorized modifications, repairs, or alterations to this product, or (excluding the U.S.) failure to strictly comply with Seiko Epson Corporation's operating and maintenance instructions.

Seiko Epson Corporation shall not be liable against any damages or problems arising from the use of any options or any consumable products other than those designated as Original Epson Products or Epson Approved Products by Seiko Epson Corporation.

The contents of this guide may be changed or updated without further notice.

Illustrations in this guide and the actual projector may differ.

## Restriction of Use

When this product is used for applications requiring high reliability/safety such as transportation devices related to aviation, rail, marine, automotive etc.; disaster prevention devices; various safety devices etc; or functional/precision devices etc, you should use this product only after giving consideration to including fail-safes and redundancies into your design to maintain safety and total system reliability. Because this product was not intended for use in applications requiring extremely high reliability/safety such as aerospace equipment, main communication equipment, nuclear power control equipment, or medical equipment related to direct medical care etc, please make your own judgment on this product's suitability after a full evaluation.

---

## Wireless Telegraphy Act Regulations

The following acts are prohibited by the Wireless Telegraphy Act.

- Modifying and disassembling (including the antenna)
- Removing the label of conformance

---

## About Notations

Microsoft® Windows® 2000 operating system

Microsoft® Windows® XP operating system

Microsoft® Windows Vista® operating system

Microsoft® Windows® 7 operating system

Microsoft® Windows® 8 operating system

Microsoft® Windows® 8.1 operating system

In this guide, the operating systems above are referred to as "Windows 2000", "Windows XP", "Windows Vista", "Windows 7", "Windows 8", and "Windows 8.1". Furthermore, the collective term Windows may be used to refer to Windows 2000, Windows XP, Windows Vista, Windows 7, Windows 8, and Windows 8.1, and multiple versions of Windows may be referred to as, for example, Windows 2000/XP/Vista/7/8/8.1, with the Windows notation omitted.

Mac OS X 10.3.x

Mac OS X 10.4.x

Mac OS X 10.5.x

Mac OS X 10.6.x

OS X 10.7.x

OS X 10.8.x

OS X 10.9.x

In this guide, the operating systems above are referred to as "Mac OS X 10.3.x", "Mac OS X 10.4.x", "Mac OS X 10.5.x", "Mac OS X 10.6.x", "OS X 10.7.x", "OS X 10.8.x", and "OS X 10.9.x". Furthermore, the collective term "OS X" is used to refer to them all.

## General Notice:

EPSON and ELPLP are trademarks or registered trademarks of the SEIKO EPSON CORPORATION.

Mac, Mac OS, and OS X, are trademarks of Apple Inc.

Microsoft, Windows, Windows Vista, PowerPoint, and the Windows logo are trademarks or registered trademarks of Microsoft Corporation in the United States and/or other countries.

enloop® is a registered trademark of the Panasonic Group.

WPA™ and WPA2™ are registered trademarks of Wi-Fi Alliance.

App Store is a service mark of Apple Inc.

Google play is a trademark of Google Inc.

HDMI and High-Definition Multimedia Interface are the trademarks or registered trademarks of HDMI Licensing LLC. 

MHL, the MHL logo, and Mobile High-Definition Link are the trademarks or registered trademarks of MHL and LLC in the United States and/or other countries.

PJLink trademark is a trademark applied for registration or is already registered in Japan, the United States of America and other countries and areas.

Crestron and Crestron RoomView are registered trademarks of Crestron Electronics, Inc.

Other product names used herein are also for identification purposes only and may be trademarks of their respective owners. Epson disclaims any and all rights in those marks.

©SEIKO EPSON CORPORATION 2014. All rights reserved.

## Indication of the manufacturer and the importer in accordance with requirements of directive 2011/65/EU (RoHS)

Manufacturer: SEIKO EPSON CORPORATION

Address: 3-5, Owa 3-chome, Suwa-shi, Nagano-ken 392-8502 Japan

Telephone: 81-266-52-3131

Importer: SEIKO EUROPE B.V.

Address: Azië building, Atlas ArenA, Hoogoorddreef 5, 1101 BA Amsterdam Zuidoost  
The Netherlands

Telephone: 31-20-314-5000