

Pro
**L1100U/L1200U/L1300U/L1405U/L1500U/
L1505U User's Guide**

Contents

Pro L1100U/L1200U/L1300U/L1405U/L1500U/L1505U User's Guide	11
Introduction to Your Projector	12
Projector Features.....	12
Product Box Contents.....	13
Additional Components	15
Additional Projector Software and Manuals	16
Optional Equipment and Replacement Parts.....	17
Warranty and Registration Information	19
Notations Used in the Documentation	19
Where to Go for Additional Information	20
Projector Part Locations	20
Projector Parts - Front/Top	21
Projector Parts - Rear	22
Projector Parts - Interface Ports	23
Projector Parts - Base.....	24
Projector Parts - Control Panel	25
Projector Parts - Remote Control.....	26
Setting Up the Projector	29
Projector Placement.....	29
Projector Setup and Installation Options	29
Projection Distance.....	32
Projector Connections	38
Connecting to Video Sources	39
Connecting to an HDMI Video Source	39
Connecting to a Component-to-BNC Video Source	40
Connecting to a Component Video Source	40
Connecting to an SDI Video Source.....	41
Connecting to a Video Source for Sound	42
Connecting to Computer Sources.....	42
Connecting to a Computer for VGA Video.....	43

Connecting to a Computer for HDMI Video and Audio	43
Connecting to a Computer for DVI-D Video	44
Connecting to a Computer for 5 BNC Video.....	45
Connecting to a Computer for Sound.....	45
Connecting to an HDBaseT Transmitter	46
Connecting to an External Computer Monitor.....	47
Connecting to External Speakers	48
Attaching and Removing a Lens.....	49
Attaching a Lens	49
Removing a Lens	52
Attaching and Removing the Cable Cover.....	53
Attaching and Removing the Cable Clip.....	54
Installing Batteries in the Remote Control	55
Using the Projector on a Network	57
Wired Network Projection.....	57
Connecting to a Wired Network	57
Selecting Wired Network Settings	58
Wireless Network Projection	61
Installing the Wireless LAN Module	61
Using Quick Wireless Connection (Windows Only)	64
Selecting Wireless Network Settings Manually.....	66
Wireless LAN Menu Settings	69
Selecting Wireless Network Settings in OS X.....	70
Selecting Wireless Network Settings in Windows.....	70
Setting Up Projector Network E-Mail Alerts	71
Network Projector E-mail Alert Messages	72
Selecting Other Network Settings.....	72
Controlling a Networked Projector Using a Web Browser	74
Web Control Options	75
Crestron RoomView Support.....	81
Setting Up Crestron RoomView Support	81
Controlling a Networked Projector Using Crestron RoomView	82

Using Basic Projector Features	84
Turning On the Projector	84
Using the Home Screen.....	86
Turning Off the Projector	87
Selecting the Language for the Projector Menus.....	88
Resizing the Image with the Zoom Button	89
Focusing the Image Using the Focus Button.....	90
Focusing the Image with an Optional Short Throw Lens.....	91
Setting the Lens Type	93
Setting the Screen Type.....	93
Adjusting the Image Position Using Lens Shift.....	94
Adjusting the Image Position Using Screen Position.....	97
Displaying a Test Pattern	98
Available Test Pattern Image Adjustments.....	99
Adjusting the Image Height	100
Image Shape.....	101
Correcting Image Shape with H/V Keystone.....	101
Correcting Image Shape with Quick Corner	104
Correcting Image Shape with Curved Surface	106
Correcting Image Shape with Corner Wall.....	110
Correcting Image Shape with Point Correction.....	115
Selecting an Image Source	118
Remote Control Operation	120
Projection Modes	122
Changing the Projection Mode Using the Remote Control	122
Changing the Projection Mode Using the Menus.....	123
Image Aspect Ratio.....	124
Changing the Image Aspect Ratio.....	124
Available Image Aspect Ratios	125
Color Mode.....	126
Changing the Color Mode.....	126
Available Color Modes.....	127
Adjusting the Brightness.....	128

Constant Brightness Usage Hours	130
Turning On Automatic Luminance Adjustment	132
Controlling the Volume with the Volume Buttons.....	133
Setting the Date and Time	134
Date and Time Settings	135
Adjusting Projector Features	137
Shutting Off the Picture and Sound Temporarily	137
Stopping Video Action Temporarily	138
Zooming Into and Out of Images	139
Projector Security Features.....	140
Password Security Types	140
Setting a Password	141
Selecting Password Security Types.....	142
Entering a Password to Use the Projector.....	143
Saving a User's Logo Image to Display.....	144
Locking the Projector's Buttons	146
Unlocking the Projector's Buttons	147
Locking the Remote Control Buttons	147
Installing a Security Cable	148
Projecting Two Images Simultaneously.....	149
Input Sources for Split Screen Projection	150
Using Advanced Image Adjustment Features	151
Using Frame Interpolation	152
Using 4K Enhancement.....	153
Creating Image Presets.....	155
Using MPEG Noise Reduction.....	156
Adjusting Scaled Resolution Images (Super-resolution)	157
Adjusting Detail Enhancement	159
Adjusting the Color Convergence (Panel Alignment).....	160
Adjusting the Color Tone (Color Uniformity)	162
Using Multiple Projectors.....	164
Multiple Projector Adjustment Overview	164
Projector Identification System for Multiple Projector Control	166

Setting the Projector ID	166
Setting the Remote Control ID	167
Tiling Images into One Image	168
Configuring Tiling Automatically	168
Configuring Tiling Manually	171
Blending the Image Edges	173
Adjusting the Black Level	175
Matching Tint and Brightness (Screen Matching)	179
Matching the Screens Automatically	179
Matching the Screens Manually	181
Scaling an Image	182
Enabling Protocol Emulation	184
Viewing 3D Images	185
Saving Settings to Memory and Using Saved Settings	185
Saving a Scheduled Event	188
Viewing Scheduled Events	188
Editing a Scheduled Event	189
Copying Menu Settings Between Projectors	190
Saving Settings to a USB Flash Drive	191
Transferring Settings From a USB Flash Drive	193
Saving Settings to a Computer	194
Transferring Settings From a Computer	196
Adjusting the Menu Settings	199
Using the Projector's Menus	199
Image Quality Settings - Image Menu	201
Input Signal Settings - Signal Menu	204
Projector Feature Settings - Settings Menu	207
Projector Setup Settings - Extended Menu	211
Projector Network Settings - Network Menu	218
Projector Information Display - Info Menu	220
Event ID Code List	222
Projector Reset Options - Reset Menu	223

Maintaining and Transporting the Projector	225
Projector Maintenance	225
Cleaning the Lens.....	225
Cleaning the Projector Case.....	226
Air Filter and Vent Maintenance	226
Cleaning the Air Filter.....	227
Replacing the Air Filter.....	230
Replacing the Remote Control Batteries	233
Transporting the Projector	235
Solving Problems	236
Projection Problem Tips	236
Projector Light Status	237
Viewing the Status Display	241
Projector Status Display Messages	242
Using the Projector Help Displays	247
Solving Image or Sound Problems	247
Solutions When No Image Appears.....	248
Solutions When "No Signal" Message Appears.....	249
Displaying From a PC Laptop	249
Displaying From a Mac Laptop	249
Solutions When "Not Supported" Message Appears	250
Solutions When Only a Partial Image Appears.....	250
Solutions When the Image is Not Rectangular	251
Solutions When the Image Contains Noise or Static	251
Solutions When the Image is Fuzzy or Blurry	252
Solutions When the Image Brightness or Colors are Incorrect	253
Solutions to Sound Problems	254
Solving Projector or Remote Control Operation Problems	255
Solutions to Projector Power or Shut-Off Problems	255
Solutions to Problems with the Remote Control.....	256
Solutions to Password Problems	257
Solving Network Problems	257
Solutions When You Cannot Access the Projector Through the Web	257

Solutions When Network Alert E-Mails are Not Received.....	258
Where to Get Help.....	258
Technical Specifications	260
General Projector Specifications	260
Projector Light Source Specifications.....	263
Remote Control Specifications	264
Projector Dimension Specifications.....	264
Projector Electrical Specifications	265
Projector Environmental Specifications.....	268
Projector Safety and Approvals Specifications.....	268
Supported Video Display Formats.....	268
Notices	272
Recycling.....	272
Important Safety Information	272
Important Safety Instructions.....	272
Laser Safety Information	275
Laser Light Source Warning	281
Restriction of Use	282
List of Safety Symbols (corresponding to IEC60950-1 A2).....	283
FCC Compliance Statement.....	286
Open Source Software License.....	287
Trademarks	334
Copyright Notice.....	334
A Note Concerning Responsible Use of Copyrighted Materials.....	335
Copyright Attribution	335

Pro L1100U/L1200U/L1300U/L1405U/L1500U/L1505U User's Guide

Welcome to the Pro L1100U/L1200U/L1300U/L1405U/L1500U/L1505U *User's Guide*.

For a printable PDF copy of this guide, [click here](#).

Introduction to Your Projector

Refer to these sections to learn more about your projector and this manual.

[Projector Features](#)

[Notations Used in the Documentation](#)

[Where to Go for Additional Information](#)

[Projector Part Locations](#)

Projector Features

The Pro L1100U, L1200U, L1300U, L1405U, L1500U, and L1505U projectors include these special features:

Bright, high-resolution projection system

- Pro L1100U: Up to 6000 lumens of brightness (white light output and color light output)
Pro L1200U: Up to 7000 lumens of brightness (white light output and color light output)
Pro L1300U/L1405U: Up to 8000 lumens of brightness (white light output and color light output)
Pro L1500U/L1505U: Up to 12000 lumens of brightness (white light output and color light output)

Note: Color brightness (color light output) and white brightness (white light output) will vary depending on usage conditions. Color light output measured in accordance with IDMS 15.4; white light output measured in accordance with ISO 21118.

- Native resolution of 1920 × 1200 pixels (WUXGA)

Flexible connectivity

- Wired and wireless (optional) network support for projection, monitoring, and control via remote network computer
- Variety of connection methods for a computer or video device including HDMI, BNC, DVI-D, SDI (Pro L1405U/L1500U/L1505U), and HDBaseT
- Ports for connecting an external monitor and external speakers

Easy-to-use setup and operation features

- Interchangeable bayonet lens options available
- Project images side by side from two separate input sources

- Create one large seamless display when projecting from multiple projectors using Edge Blending
- Epson's Instant Off and Direct Power On features for quick setup and shut down
- Support for Crestron RoomView network monitoring systems
- Network message broadcast system to project timely messages to all networked projectors (Windows only)

[Product Box Contents](#)

[Additional Components](#)

[Additional Projector Software and Manuals](#)

[Optional Equipment and Replacement Parts](#)

[Warranty and Registration Information](#)

Parent topic: [Introduction to Your Projector](#)

Related concepts

[Projector Part Locations](#)

[Projector Connections](#)

[Using Multiple Projectors](#)

[Crestron RoomView Support](#)

Related references

[Optional Equipment and Replacement Parts](#)

Related tasks

[Projecting Two Images Simultaneously](#)

Related topics

[Using the Projector on a Network](#)

Product Box Contents

Save all the packaging in case you need to ship the projector. Always use the original packaging (or equivalent) when shipping.

Make sure your projector box included all of these parts:

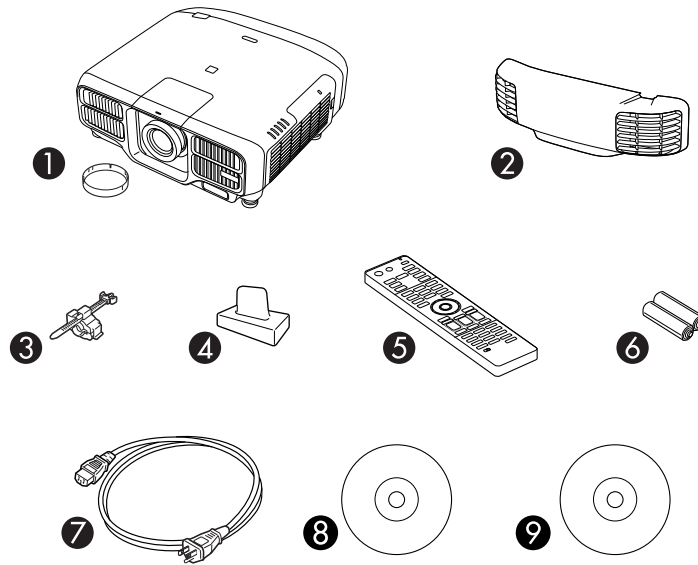

- 1 Projector with standard zoom lens and lens cap*
- 2 Cable cover
- 3 Cable clip (Pro L1405U/L1500U/L1505U)
- 4 Lens connector cap
- 5 Remote control
- 6 Remote control batteries (two AA alkaline)
- 7 Power cord
- 8 Projector documentation CD
- 9 Projector software CD

* Lens and lens cap not included with the Pro
L1100UNL/L1200UNL/L1300UNL/L1405UNL/L1500UNL/L1505UNL

Parent topic: [Projector Features](#)

Related concepts

[Projector Connections](#)

Additional Components

Depending on how you plan to use the projector, you may need to obtain additional components.

Note: To connect a Mac that does not include a compatible video output port, you need to obtain an adapter that allows you to connect to an input port on the projector. Contact Apple for compatible adapter options. To connect a smartphone or tablet, you may need to obtain an adapter that allows you to connect to the projector. This allows you to mirror your smartphone or tablet screens, watch movies, and more. Contact your device manufacturer for compatible adapter options.

Unless listed as available from Epson in this table, see your local computer or electronics dealer for purchase information.

Signal or connection type	Additional component necessary
Component video	Component-to-BNC or D-sub, 15-pin, component-to-VGA video cable or adapter Available for purchase from Epson or an authorized Epson reseller.
HDMI	HDMI cable Available for purchase from Epson or an authorized Epson reseller. You also need a splitter that supports HDMI signals (commercially available).
MHL	MHL-compatible device or device with an integrated MHL connector, MHL cable, or HDMI cable and MHL adapter compatible with your device Available for purchase from Epson or an authorized Epson reseller.
3D	Three compatible HDMI cables, a splitter that supports 3D signals, and a silver screen (recommended gain: 2.3 to 2.7) You can purchase HDMI cables from Epson or an authorized Epson reseller. Note: If your video source is a 3D Blu-ray disc, you also need a Blu-ray player that supports 3D playback. See your local computer or electronics dealer for purchase information.

Signal or connection type	Additional component necessary
Audio from certain ports	Commercially available audio cable compatible with your device
VGA	VGA computer cable Available for purchase from Epson or an authorized Epson reseller. If you want to connect the projector using a splitter, you also need a splitter that supports VGA signals (commercially available) and a second VGA computer cable.
BNC	VGA-to-5-BNC cable or adapter Available for purchase from Epson or an authorized Epson reseller.
DVI-D	Compatible DVI-D cable
HDBaseT	Compatible 100Base-TX LAN cable
SDI (Pro L1405U/L1500U/L1505U)	Compatible BNC video cable

Parent topic: [Projector Features](#)

Related concepts

[Projector Connections](#)

Additional Projector Software and Manuals

After connecting and setting up the projector, install the projector software from the included software CD, or download the software and manuals as necessary.

You can install the projector software programs listed here and view their manuals for instructions on using them.

Note: If you still need help after checking this manual and the sources listed here, you can use the Epson PrivateLine Support service to get help fast. For details, see "Where to Get Help".

Projector software	Manual	Description
EasyMP Monitor (Windows only)	<i>EasyMP Monitor Operation Guide</i>	Lets you monitor and control your projector through the network. You can download the latest software and documentation from the Epson web site. Go to epson.com/support (U.S.) or epson.ca/support (Canada) and select your projector.
EasyMP Multi PC Projection	<i>EasyMP Multi PC Projection Operation Guide</i>	Lets you hold interactive meetings by projecting the computer screens of users over a network.
EasyMP Network Updater (Windows only)	<i>EasyMP Network Updater Operation Guide</i>	Lets you update firmware for a projector over a wired LAN. You can download the latest software and documentation from the Epson web site. Go to epson.com/support (U.S.) or epson.ca/support (Canada) and select your projector.
Epson iProjection app	Instructions are included with the app	Lets you project from an iOS or Android device if your projector is connected to a network that includes a wireless access point. Visit epson.com/projectorapp (U.S.) or epson.ca/projectorapp (Canada) for more information.

Parent topic: [Projector Features](#)

Optional Equipment and Replacement Parts

You can purchase screens, other optional accessories, and replacement parts from an Epson authorized reseller. To find the nearest reseller, call 800-GO-EPSON (800-463-7766). Or you can purchase online at epsonstore.com (U.S. sales) or epson.ca (Canadian sales).

Epson offers the following optional accessories and replacement parts for your projector:

Option or part	Part number
Air filter (ELPAF51)	V13H134A51
Quick Wireless Connection USB key (ELPAP09)	V12H005M09

Option or part	Part number
Wireless LAN module (ELPAP10)	V12H731P02
HDBaseT Transmitter (ELPHD01)	V12H547020
Replacement remote control	158279900
Remote control cable set (ELPKC28)	V12H005C28
Epson DC-11 document camera (ELPDC11)	V12H377020
Epson DC-13 document camera (ELPDC13)	V12H757020
Epson DC-20 document camera (ELPDC20)	V12H500020
Epson DC-21 document camera (ELPDC21)	V12H758020
Wireless IR mouse receiver for remote control (ELPST16)	V12H007T16
Passive 3D glasses (adult; ELPGS02A)	V12H541A20
Passive 3D glasses (children; ELPGS02B)	V12H541B20
Low ceiling mount (ELPMB47)	V12H802010
High ceiling mount (ELPMB48)	V12H803010
Component-to-VGA video cable	ELPKC19
VGA video cable 10 feet (3.0 m) length	F3H982-10
HDMI audio video cable 3 feet (0.9 m) length	AV22300-03
HDMI audio video cable 6 feet (1.8 m) length	AV22300-06
Ultra short throw zoom lens (ELPLX01; Pro L1100U/L1200U/L1300U/L1405U only)	V12H004X01
Short throw zoom lens #1 (ELPLU03)	V12H004U03
Short throw zoom lens #2 (ELPLU04)	V12H004U04
Wide throw zoom lens #1 (ELPLW05)	V12H004W05
Wide throw zoom lens #2 (ELPLW06)	V12H004W06
Middle throw zoom lens #1 ¹ (ELPLM08; Pro L1100U/L1200U/L1300U/L1405U only)	V12H004M0A
Middle throw zoom lens #2 ² (ELPLM09)	V12H004M0B
Middle throw zoom lens #3 (ELPLM10)	V12H004M10

Option or part	Part number
Middle throw zoom lens #4 (ELPLM11)	V12H004M11
Long throw zoom lens (ELPLL08)	V12H004L08

¹ Standard zoom lens for Pro L1100U/L1200U/L1300U/L1405U.

² Standard zoom lens for Pro L1500U/L1505U.

Note: The following lenses are also supported: ELPLU02, ELPLR04, ELPLW04, ELPLS04, ELPLM06, ELPLM07, ELPLL07.

Parent topic: [Projector Features](#)

Warranty and Registration Information

Your projector comes with a basic warranty that lets you project with confidence. For details, see the warranty that came with your projector.

In addition, Epson offers free Extra Care Road Service. In the unlikely event of an equipment failure, you won't have to wait for your unit to be repaired. Instead, Epson will ship you a replacement unit anywhere in the United States, Canada, or Puerto Rico. See the Extra Care Road Service brochure for details.

Register your product online using the projector CD or at this site: epson.com/webreg.

Registering also lets you receive special updates on new accessories, products, and services.

Parent topic: [Projector Features](#)

Notations Used in the Documentation

Follow the guidelines in these notations as you read your documentation:

- **Warnings** must be followed carefully to avoid bodily injury.
- **Cautions** must be observed to avoid damage to your equipment.
- **Notes** contain important information about your projector.
- **Tips** contain additional projection information.

Parent topic: [Introduction to Your Projector](#)

Where to Go for Additional Information

Need quick help on using your projector? Here's where to look for help:

- Built-in help system

Press the **Home** button on the remote control or projector, select **Help**, and press **Enter** to get quick solutions to common problems.

- epson.com/support (U.S) or epson.ca/support (Canada)

View FAQs (frequently asked questions) and e-mail your questions to Epson technical support 24 hours a day.

- If you still need help after checking this manual and any other sources listed here, you can use the Epson PrivateLine Support service to get help fast. For details, see "Where to Get Help".

Parent topic: [Introduction to Your Projector](#)

Related tasks

[Using the Projector Help Displays](#)

Projector Part Locations

Check the projector part illustrations to learn about the parts on your projector.

[Projector Parts - Front/Top](#)

[Projector Parts - Rear](#)

[Projector Parts - Interface Ports](#)

[Projector Parts - Base](#)

[Projector Parts - Control Panel](#)

[Projector Parts - Remote Control](#)

Parent topic: [Introduction to Your Projector](#)

Projector Parts - Front/Top

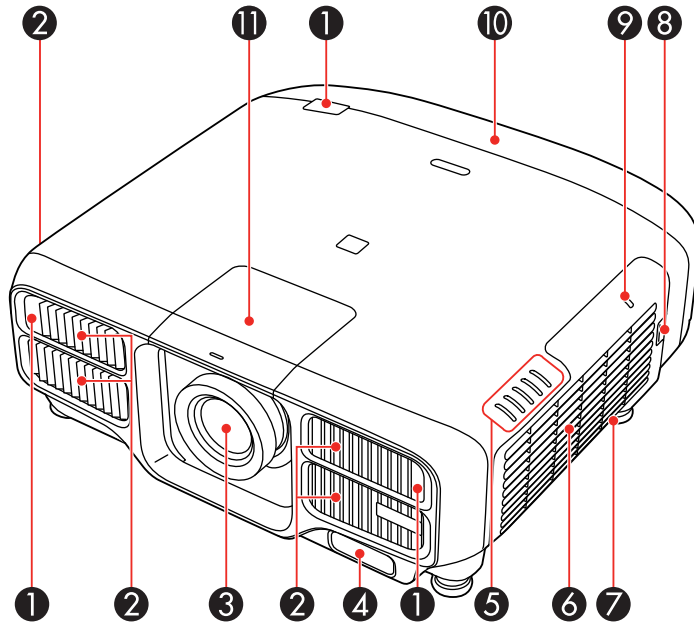

- 1 Remote receiver
- 2 Air intake vents
- 3 Projection lens
- 4 Built-in camera
- 5 Projector status lights
- 6 Air filter cover/intake vent
- 7 Speaker (Pro L1100U/L1200U/L1300U)
- 8 Air filter cover latch
- 9 Wireless LAN module indicator light
- 10 Cable cover
- 11 Lens replacement cover

Parent topic: [Projector Part Locations](#)

Projector Parts - Rear

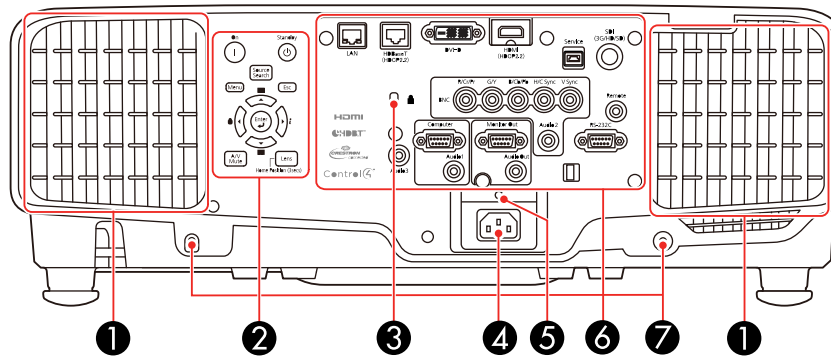

- 1 Air exhaust vents
- 2 Control panel
- 3 Kensington security slot
- 4 AC input
- 5 Cable clip slot
- 6 Interface ports
- 7 Cable cover screw holes

Parent topic: [Projector Part Locations](#)

Projector Parts - Interface Ports

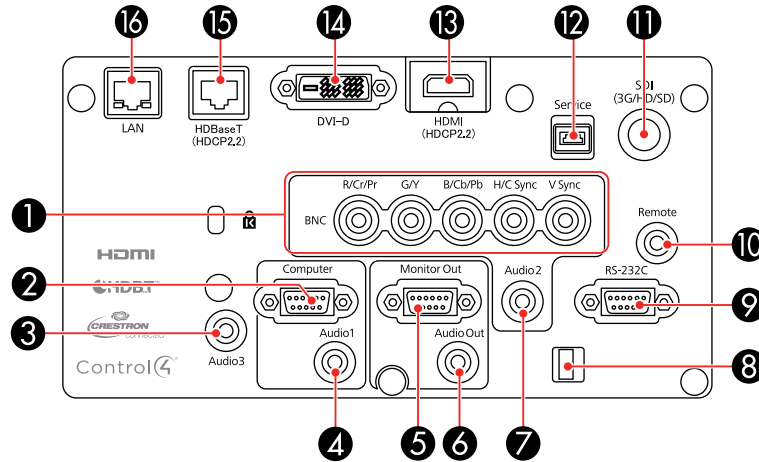

- 1 **BNC** ports
- 2 **Computer** port
- 3 **Audio3** port
- 4 **Audio1** port
- 5 **Monitor Out** port
- 6 **Audio Out** port
- 7 **Audio2** port
- 8 Cable clip slot
- 9 **RS-232C** port
- 10 **Remote** port
- 11 **SDI** port (Pro L1405U/L1500U/L1505U)
- 12 **Service** port
- 13 **HDMI** port
- 14 **DVI-D** port
- 15 **HDBaseT** port

16 Network LAN port

Parent topic: [Projector Part Locations](#)

Projector Parts - Base

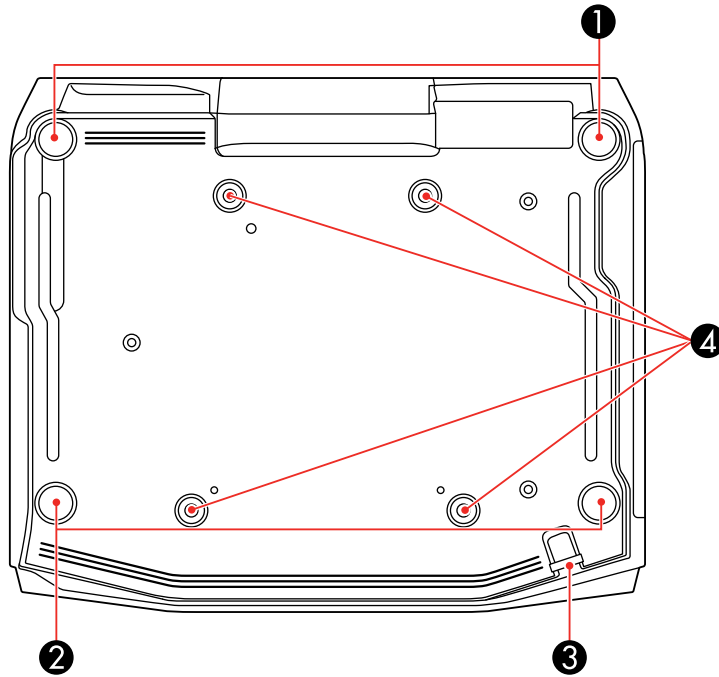

- 1 Front adjustable feet
- 2 Rear feet
- 3 Security cable attachment point
- 4 Mounting bracket holes

Parent topic: [Projector Part Locations](#)

Projector Parts - Control Panel

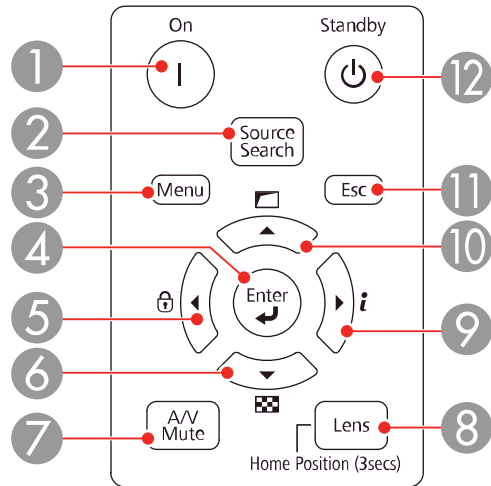

- 1 **On** button (turns on the projector)
- 2 **Source Search** button (searches for connected sources)
- 3 **Menu** button (accesses projector menu system)
- 4 **Enter** button (selects options)
- 5 Left arrow button and displays the Control Panel Lock screen
- 6 Down arrow button and displays a test pattern
- 7 **A/V Mute** button (turns the video and audio on or off)
- 8 **Lens** button (displays the lens shift, zoom, focus, and distortion adjustment screens; hold for 3 seconds to return the lens to the home position)
- 9 Right arrow button and displays the Info menu
- 10 Up arrow button and displays screen adjustment options
- 11 **Esc** button (cancels/exits functions)
- 12 **Standby** button (turns off the projector)

Parent topic: [Projector Part Locations](#)

Related references

[Projector Parts - Remote Control](#)

Projector Parts - Remote Control

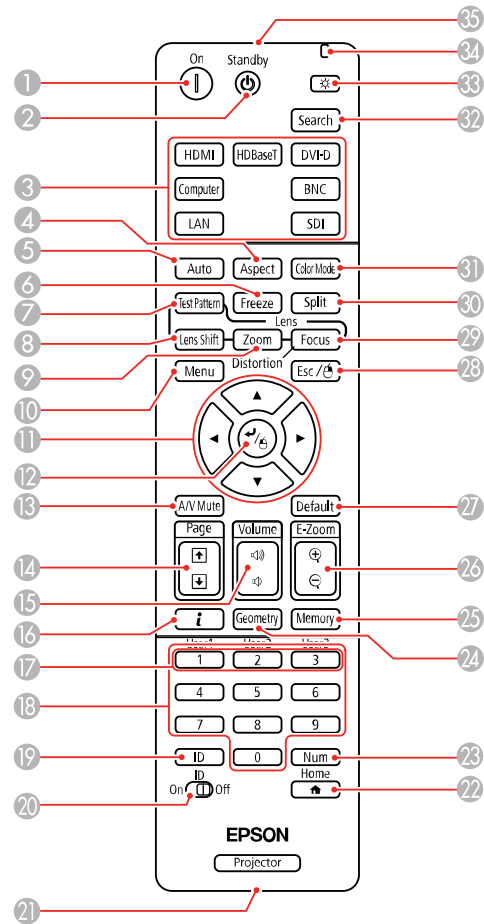

- 1 **On** button (turns on the projector)
- 2 **Standby** button (turns off the projector)
- 3 Source buttons (select an image source)

- 4 **Aspect** button (selects the image aspect ratio)
- 5 **Auto** button (automatically adjusts computer images)
- 6 **Freeze** button (stops video action)
- 7 **Test Pattern** button (displays a test pattern)
- 8 **Lens Shift** button (adjusts the image position)
- 9 **Zoom** button (changes the image size)
- 10 **Menu** button (accesses projector menu system)
- 11 Arrow buttons (move through on-screen options and move pointer)
- 12 Enter button (selects options and left mouse button)
- 13 **A/V Mute** button (turns the video and audio on or off)
- 14 **Page** up and down buttons (scroll through image files when projecting from a computer over a network connection)
- 15 **Volume** up and down buttons (adjust speaker volume)
- 16 **i** button (displays the Info menu)
- 17 **User1**, **User2**, and **User3** buttons (open menu assigned by user)
- 18 Numeric buttons (enter numbers)
- 19 **ID** button (hold down and use numeric keys to select projector to control)
- 20 **ID** switch (control one or all projectors)
- 21 Remote port (connects to a remote control cable)
- 22 **Home** button (displays the home screen)
- 23 **Num** button (hold down and use numeric keys to enter numbers)
- 24 **Geometry** button (corrects image distortion)
- 25 **Memory** button (saves and applies presets)
- 26 **E-Zoom +/-** buttons (zoom into and out of the image)
- 27 **Default** button (resets settings to their default values in the projector menu system)
- 28 **Esc** button (cancels/exits functions and right mouse button)
- 29 **Focus** button (adjusts the image focus)
- 30 **Split** button (splits the screen between two inputs)

- 31 **Color Mode** button (selects display modes)
- 32 **Search** button (searches for connected sources)
- 33 Light button (lights up the remote control buttons temporarily)
- 34 Indicator light (lights up when the remote control is in use)
- 35 Remote control signal emitter (emits remote control signals)

Parent topic: [Projector Part Locations](#)

Setting Up the Projector

Follow the instructions in these sections to set up your projector for use.

[Projector Placement](#)

[Projector Connections](#)

[Attaching and Removing a Lens](#)

[Attaching and Removing the Cable Cover](#)

[Attaching and Removing the Cable Clip](#)

[Installing Batteries in the Remote Control](#)

Projector Placement

You can place the projector on almost any flat surface to project an image.

You can also install the projector in a ceiling mount if you want to use it in a fixed location.

Keep these considerations in mind as you select a projector location:

- Place the projector on a sturdy, level surface or install it using a compatible mount.
- Leave plenty of space around and under the projector for ventilation, and do not place it on top of or next to anything that could block the vents.
- Position the projector within reach of a grounded electrical outlet or extension cord.

[Projector Setup and Installation Options](#)

[Projection Distance](#)

Parent topic: [Setting Up the Projector](#)

Projector Setup and Installation Options

You can set up or install your projector in the following ways:

Front

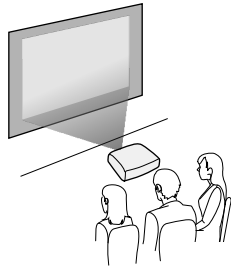

Rear

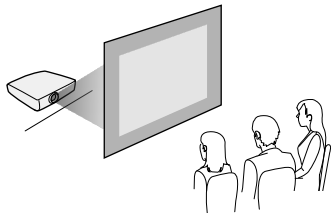

Front ceiling

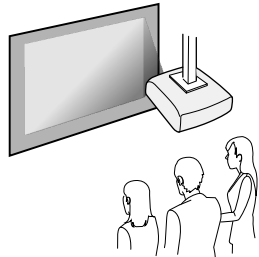

Rear ceiling

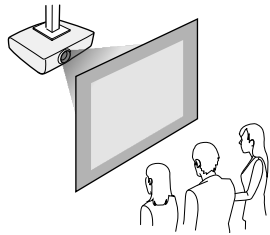

Note: Be sure to leave at least 20 inches (50 cm) of space in front of the air exhaust and intake vents and, when setting up multiple projectors, 20 inches (50 cm) of space between the projectors.

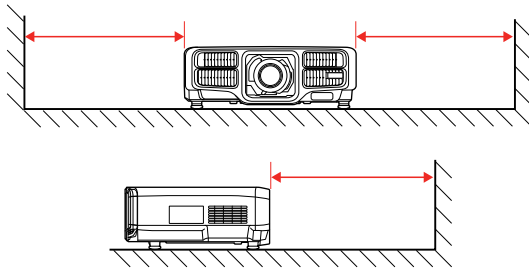

You can mount the projector to the ceiling at any horizontal or vertical angle.

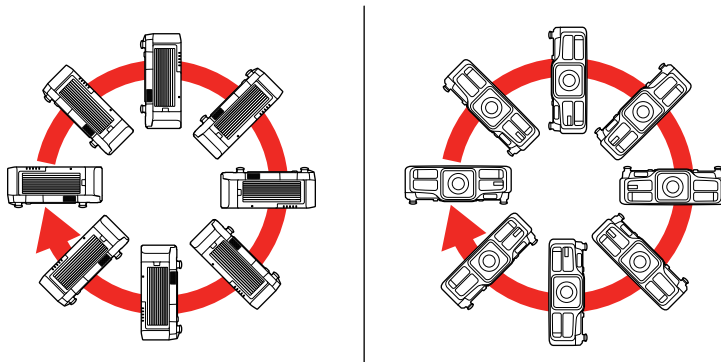

If you project from the ceiling or from the rear, select the correct **Projection** setting and, if necessary, turn on the **Inv Direction Button** setting and adjust the **OSD Rotation** setting.

Parent topic: [Projector Placement](#)

Related references

[Projector Setup Settings - Extended Menu](#)

Projection Distance

The distance at which you place the projector from the screen determines the approximate size of the image. The image size increases the farther the projector is from the screen, but can vary depending on the zoom factor, aspect ratio, and other settings.

Use the tables here to determine approximately how far to place the projector from the screen based on the size of the projected image. (Conversion figures may have been rounded up or down.)

You can also use the projector Throw Distance Calculator at epson.com/support (U.S.) or epson.ca/support (Canada).

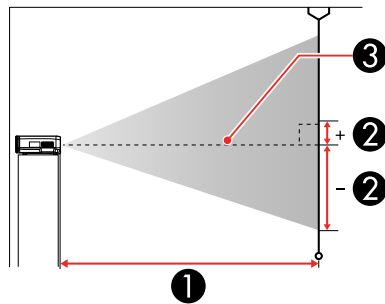
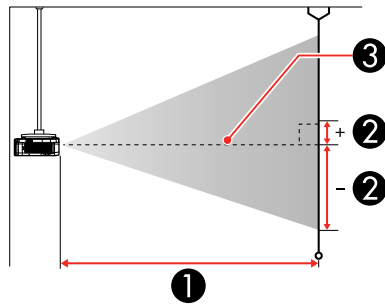

- 1 Projection distance
- 2 Distance from the center of the lens to the base of the image (varies depending on vertical lens shift)
- 3 Center of lens

Pro L1100U/L1200U/L1300U/L1405U (Standard Zoom Lens)

16:10 Aspect Ratio Image or Screen		
Screen or image size	Projection distance (1) Wide to Tele (Minimum to Maximum)	Vertical lens shift (2) Top to bottom
50 inches	60 to 98 inches (153 to 248 cm)	-31.2 to 4.7 inches (-79 to 12 cm)
60 inches	73 to 117 inches (185 to 298 cm)	-37.4 to 5.6 inches (-95 to 14 cm)
80 inches	98 to 157 inches (248 to 399 cm)	-49.9 to 7.5 inches (-127 to 19 cm)
100 inches	123 to 197 inches (311 to 500 cm)	-62.4 to 9.4 inches (-158 to 24 cm)
120 inches	147 to 237 inches (374 to 601 cm)	-74.8 to 11.2 inches (-190 to 29 cm)
150 inches	185 to 296 inches (469 to 753 cm)	-93.7 to 14.2 inches (-238 to 36 cm)
200 inches	247 to 396 inches (627 to 1005 cm)	-124.7 to 18.7 inches (-317 to 48 cm)
250 inches	309 to 495 inches (785 to 1258 cm)	-155.9 to 23.2 inches (-396 to 59 cm)
300 inches	371 to 595 inches (943 to 1510 cm)	-187.1 to 28.1 inches (-475 to 71 cm)

16:9 Aspect Ratio Image or Screen		
Screen or image size	Projection distance (1) Wide to Tele (Minimum to Maximum)	Vertical lens shift (2) Top to bottom
49 inches	61 to 98 inches (154 to 250 cm)	-30.1 to 6.0 inches (-76 to 15 cm)
50 inches	62 to 100 inches (157 to 255 cm)	-30.7 to 6.3 inches (-78 to 16 cm)
60 inches	75 to 121 inches (190 to 307 cm)	-36.8 to 7.4 inches (-94 to 19 cm)
80 inches	100 to 162 inches (255 to 411 cm)	-49.1 to 9.9 inches (-125 to 25 cm)
100 inches	126 to 203 inches (320 to 514 cm)	-61.4 to 12.3 inches (-156 to 31 cm)
120 inches	152 to 243 inches (385 to 618 cm)	-73.6 to 14.8 inches (-187 to 38 cm)
150 inches	190 to 305 inches (482 to 774 cm)	-92 to 18.5 inches (-234 to 47 cm)
200 inches	254 to 407 inches (645 to 1033 cm)	-122.7 to 24.7 inches (-312 to 63 cm)
250 inches	318 to 509 inches (807 to 1293 cm)	-153.5 to 30.7 inches (-390 to 78 cm)
290 inches	369 to 591 inches (937 to 1500 cm)	-178 to 35.8 inches (-452 to 91 cm)

4:3 Aspect Ratio Image or Screen		
Screen or image size	Projection distance (1) Wide to Tele (Minimum to Maximum)	Vertical lens shift (2) Top to bottom
45 inches	61 to 99 inches (156 to 253 cm)	-31.8 to 4.8 inches (-81 to 12 cm)
50 inches	68 to 111 inches (174 to 281 cm)	-35.4 to 5.1 inches (-90 to 13 cm)
60 inches	83 to 133 inches (210 to 338 cm)	-42.4 to 6.4 inches (-108 to 16 cm)
80 inches	111 to 178 inches (281 to 453 cm)	-56.5 to 8.5 inches (-143 to 22 cm)
100 inches	139 to 223 inches (353 to 567 cm)	-70.6 to 10.6 inches (-179 to 27 cm)
120 inches	167 to 268 inches (424 to 681 cm)	-84.7 to 12.7 inches (-215 to 32 cm)
150 inches	209 to 336 inches (532 to 853 cm)	-105.9 to 15.9 inches (-269 to 40 cm)
200 inches	280 to 448 inches (711 to 1139 cm)	-141.2 to 21.2 inches (-359 to 54 cm)
250 inches	350 to 561 inches (890 to 1424 cm)	-176.4 to 26.4 inches (-448 to 67 cm)
265 inches	371 to 595 inches (943 to 1510 cm)	-187.1 to 28.1 inches (-475 to 71 cm)

Pro L1500U/L1505U (Standard Zoom Lens)

16:10 Aspect Ratio Image or Screen		
Screen or image size	Projection distance (1) Wide to Tele (Minimum to Maximum)	Vertical lens shift (2) Top to bottom
60 inches	78 to 128 inches (199 to 326 cm)	-35 to 3.2 inches (-89 to 8 cm)
80 inches	105 to 172 inches (268 to 438 cm)	-46.7 to 4.3 inches (-119 to 11 cm)
100 inches	133 to 216 inches (337 to 549 cm)	-58.3 to 5.3 inches (-148 to 14 cm)
120 inches	160 to 260 inches (406 to 661 cm)	-70.0 to 6.4 inches (-178 to 16 cm)
150 inches	200 to 326 inches (509 to 828 cm)	-87.4 to 7.9 inches (-222 to 20 cm)
200 inches	269 to 436 inches (682 to 1106 cm)	-116.7 to 10.7 inches (-296 to 27 cm)
250 inches	337 to 545 inches (855 to 1385 cm)	-145.7 to 13.4 inches (-370 to 34 cm)
500 inches	676 to 1093 inches (1717 to 2777 cm)	-291.7 to 26.7 inches (-741 to 68 cm)

16:9 Aspect Ratio Image or Screen		
Screen or image size	Projection distance (1) Wide to Tele (Minimum to Maximum)	Vertical lens shift (2) Top to bottom
59 inches	79 to 130 inches (201 to 330 cm)	-33.8 to 4.8 inches (-86 to 12 cm)

16:9 Aspect Ratio Image or Screen		
Screen or image size	Projection distance (1) Wide to Tele (Minimum to Maximum)	Vertical lens shift (2) Top to bottom
60 inches	80 to 132 inches (205 to 336 cm)	-34.3 to 5.1 inches (-87 to 13 cm)
80 inches	108 to 177 inches (276 to 450 cm)	-45.8 to 6.6 inches (-116 to 17 cm)
100 inches	136 to 222 inches (347 to 565 cm)	-57.2 to 8.2 inches (-145 to 21 cm)
120 inches	164 to 267 inches (417 to 679 cm)	-68.7 to 9.8 inches (-174 to 25 cm)
150 inches	206 to 336 inches (524 to 851 cm)	-85.8 to 12.3 inches (-218 to 31 cm)
200 inches	276 to 448 inches (701 to 1137 cm)	-114.5 to 16.4 inches (-291 to 42 cm)
250 inches	346 to 560 inches (879 to 1423 cm)	-142.9 to 20.5 inches (-363 to 52 cm)
486 inches	675 to 1092 inches (1716 to 2775 cm)	-278.1 to 39.9 inches (-706 to 101 cm)

4:3 Aspect Ratio Image or Screen		
Screen or image size	Projection distance (1) Wide to Tele (Minimum to Maximum)	Vertical lens shift (2) Top to bottom
53 inches	78 to 128 inches (199 to 326 cm)	-35 to 3.2 inches (-89 to 8 cm)

4:3 Aspect Ratio Image or Screen		
Screen or image size	Projection distance (1) Wide to Tele (Minimum to Maximum)	Vertical lens shift (2) Top to bottom
60 inches	89 to 146 inches (226 to 370 cm)	-39.8 to 3.5 inches (-101 to 9 cm)
80 inches	120 to 195 inches (304 to 497 cm)	-52.8 to 4.8 inches (-134 to 12 cm)
100 inches	151 to 245 inches (383 to 623 cm)	-66.0 to 6.0 inches (-168 to 15 cm)
120 inches	181 to 295 inches (461 to 749 cm)	-79.2 to 7.2 inches (-201 to 18 cm)
150 inches	227 to 369 inches (578 to 938 cm)	-99.1 to 9.1 inches (-252 to 23 cm)
200 inches	304 to 493 inches (773 to 1253 cm)	-132.1 to 12.1 inches (-335 to 31 cm)
250 inches	381 to 618 inches (969 to 1569 cm)	-165 to 15.0 inches (-419 to 38 cm)
441 inches	675 to 1092 inches (1715 to 2773 cm)	-291.2 to 26.6 inches (-740 to 68 cm)

Parent topic: [Projector Placement](#)

Projector Connections

See these sections to connect the projector to a variety of projection sources.

Caution: If you will use the projector at altitudes above 4921 feet (1500 m), turn on **High Altitude Mode** to ensure the projector's internal temperature is regulated properly.

[Connecting to Video Sources](#)

- [Connecting to Computer Sources](#)
- [Connecting to an HDBaseT Transmitter](#)
- [Connecting to an External Computer Monitor](#)
- [Connecting to External Speakers](#)

Parent topic: [Setting Up the Projector](#)

Related references

- [Projector Setup Settings - Extended Menu](#)
- [Product Box Contents](#)

Connecting to Video Sources

Follow the instructions in these sections to connect video devices to the projector.

- [Connecting to an HDMI Video Source](#)
- [Connecting to a Component-to-BNC Video Source](#)
- [Connecting to a Component Video Source](#)
- [Connecting to an SDI Video Source](#)
- [Connecting to a Video Source for Sound](#)

Parent topic: [Projector Connections](#)

Connecting to an HDMI Video Source

If your video source has an HDMI port, you can connect it to the projector using an optional HDMI cable. The HDMI connection provides the best image quality.

1. Connect the HDMI cable to your video source's HDMI output port.
2. Connect the other end to the projector's **HDMI** port.

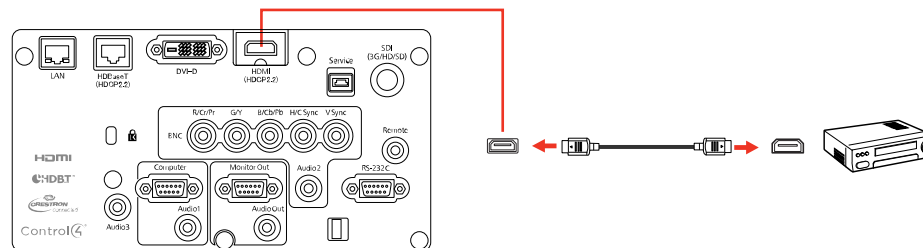

Note: The projector converts the digital audio signal sent from your video source into a mono analog signal for the internal speaker or a stereo analog signal if you are connecting to external speakers.

Note: If you have problems hearing audio through the HDMI connection, you can use the **Audio3** port instead to play sound. Connect one end of an optional 3.5 mm stereo mini-jack audio cable to the projector's **Audio3** port and the other end to your computer's audio out port. Then select **Audio3** for the **HDMI Audio Output** setting in the Extended menu.

Parent topic: [Connecting to Video Sources](#)

Related references

[Projector Setup Settings - Extended Menu](#)

Connecting to a Component-to-BNC Video Source

If your video source has component video ports, you can connect it to the projector using an optional component-to-BNC video cable. Depending on your component ports, you may need to use an adapter cable along with a component video cable.

1. Connect the component connectors to your video source's color-coded component video output ports, usually labeled **Y**, **Pb**, **Pr** or **Y**, **Cb**, **Cr**. If you are using an adapter, connect these connectors to your component video cable.
2. Connect the BNC connectors to the projector's **R/Cr/Pr**, **G/Y**, **B/Cb/Pb** ports.

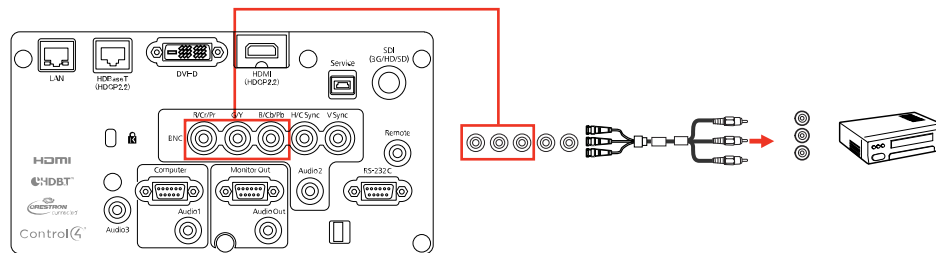

Parent topic: [Connecting to Video Sources](#)

Connecting to a Component Video Source

If your video source has component video ports, you can connect it to the projector using an optional component-to-VGA video cable. Depending on your component ports, you may need to use an adapter cable along with a component video cable.

1. Connect the component connectors to your video source's color-coded component video output ports, usually labeled **Y, Pb, Pr** or **Y, Cb, Cr**. If you are using an adapter, connect these connectors to your component video cable.
2. Connect the VGA connector to a **Computer** port on the projector.

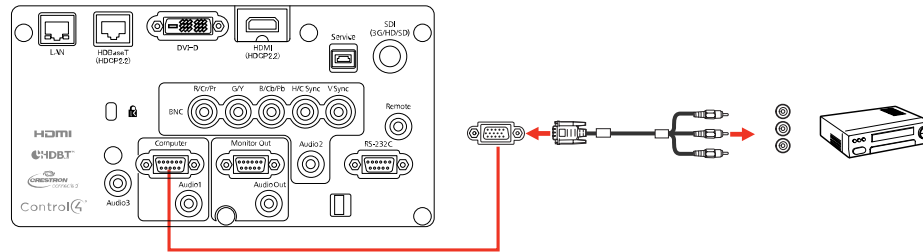

3. Tighten the screws on the VGA connector.

If your image colors appear incorrect, you may need to change the **Input Signal** setting in the projector's Signal menu.

Parent topic: [Connecting to Video Sources](#)

Related references

[Input Signal Settings - Signal Menu](#)

Connecting to an SDI Video Source

If your video source has an SDI port, you can connect it to the projector using an optional BNC video cable (Pro L1405U/L1500U/L1505U).

1. Connect the BNC video cable to your video source's SDI output port.
2. Connect the other end to the projector's **SDI** port.

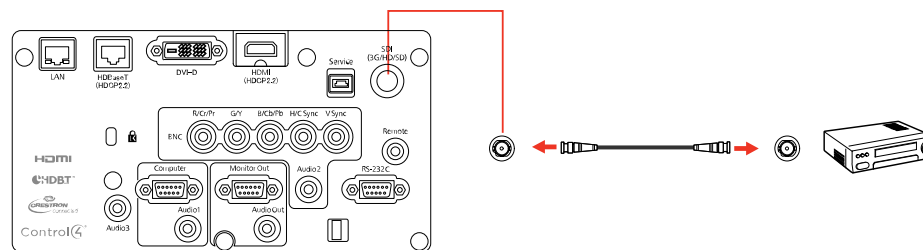

Parent topic: [Connecting to Video Sources](#)

Connecting to a Video Source for Sound

You can play sound through the projector's speaker system if your video source has audio output ports (Pro L1100U/L1200U/L1300U). Just connect an optional stereo mini-jack audio cable as described here.

Note: If your projector does not have an internal speaker system (Pro L1405U/L1500U/L1505U), you can play sound by connecting external speakers to the projector.

Note: If you connected your video source to the projector using an HDMI cable, the audio signal is transferred with the video signal; you do not need an additional cable for sound. If you connected your video source to the projector's **SDI** port (Pro L1405U/L1500U/L1505U), audio output is not supported.

1. Connect the audio cable to your video source's audio-out ports.
2. Connect the other end of the cable to the projector's **Audio** port that corresponds to the **Computer** or **BNC** port you are using for video.

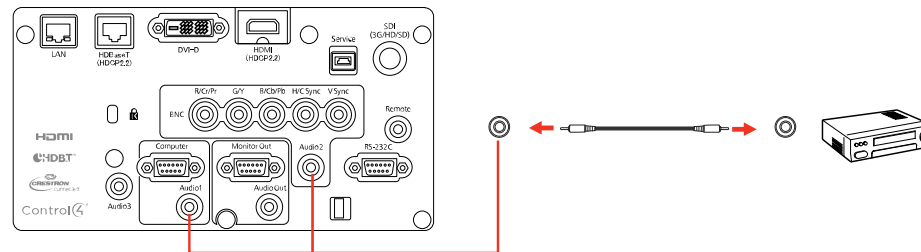

Parent topic: [Connecting to Video Sources](#)

Related tasks

[Connecting to External Speakers](#)

Connecting to Computer Sources

Follow the instructions in these sections to connect a computer to the projector.

[Connecting to a Computer for VGA Video](#)

[Connecting to a Computer for HDMI Video and Audio](#)

[Connecting to a Computer for DVI-D Video](#)

[Connecting to a Computer for 5 BNC Video](#)

Connecting to a Computer for Sound

Parent topic: [Projector Connections](#)

Connecting to a Computer for VGA Video

You can connect the projector to your computer using a VGA computer cable.

Note: To connect a Mac that includes only a Mini DisplayPort, Thunderbolt port, or Mini-DVI port for video output, you need to obtain an adapter that allows you to connect to the projector's VGA video port. Contact Apple for compatible adapter options.

1. If necessary, disconnect your computer's monitor cable.
2. Connect the VGA computer cable to your computer's monitor port.
3. Connect the other end to a **Computer** port on the projector.

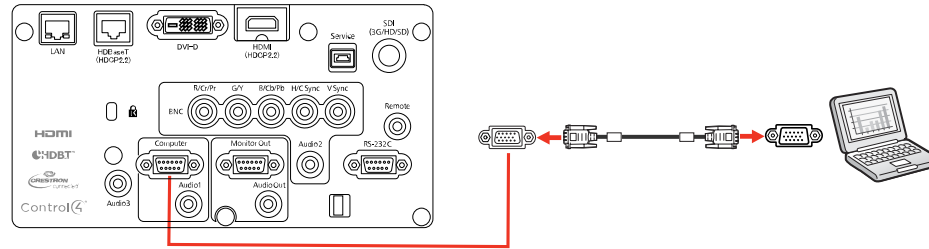

4. Tighten the screws on the VGA connector.

Parent topic: [Connecting to Computer Sources](#)

Connecting to a Computer for HDMI Video and Audio

If your computer has an HDMI port, you can connect it to the projector using an optional HDMI cable.

Note: To connect a Mac that includes only a Mini DisplayPort, Thunderbolt port, or Mini-DVI port for video output, you need to obtain an adapter that allows you to connect to the projector's **HDMI** port. Contact Apple for compatible adapter options. Older Mac computers (2009 and earlier) may not support audio through the **HDMI** port.

1. Connect the HDMI cable to your computer's HDMI output port.

2. Connect the other end to the projector's **HDMI** port.

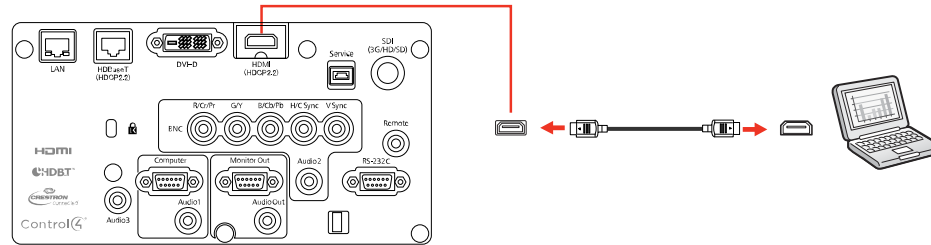

Note: The projector converts the digital audio signal sent from your computer into a mono analog signal for the internal speaker or a stereo analog signal if you are connecting to external speakers.

Note: If you have problems hearing audio through the HDMI connection, you can use the **Audio3** port instead to play sound. Connect one end of an optional 3.5 mm stereo mini-jack audio cable to the projector's **Audio3** port and the other end to your computer's audio out port. Then select **Audio3** for the **HDMI Audio Output** setting in the Extended menu.

Parent topic: [Connecting to Computer Sources](#)

Related references

[Projector Setup Settings - Extended Menu](#)

Connecting to a Computer for DVI-D Video

If your computer has a DVI-D connector, you can connect it to the projector using an optional DVI-D cable.

1. Connect the DVI-D cable to your computer's DVI-D connector.
2. Connect the other end to the projector's **DVI-D** connector.

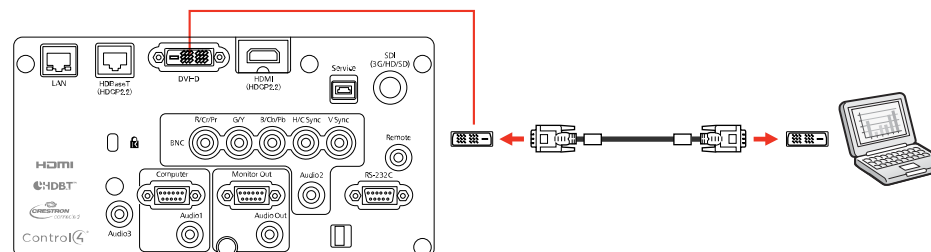

Parent topic: [Connecting to Computer Sources](#)

Connecting to a Computer for 5 BNC Video

You can connect the projector to your computer using an optional VGA-to-5-BNC cable.

1. Connect the VGA connector to your computer's monitor port.
2. Connect the 5 BNC connectors to the projector's **BNC** ports.

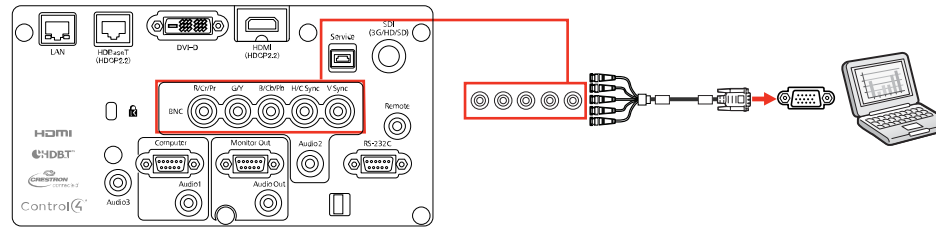

Parent topic: [Connecting to Computer Sources](#)

Connecting to a Computer for Sound

If your computer presentation includes sound and you did not connect it to the projector's **HDMI** port, you can still play sound through the projector's speaker system (Pro L1100U/L1200U/L1300U). Just connect an optional 3.5 mm stereo mini-jack audio cable as described here.

Note: If your projector does not have an internal speaker system (Pro L1405U/L1500U/L1505U), you can play sound by connecting external speakers to the projector.

1. Connect the audio cable to your laptop's headphone or audio-out jack, or your desktop's speaker or audio-out port.

2. Connect the other end to the **Audio** port that corresponds to the **Computer** or **BNC** port you are using.

Note: If you are projecting video through the projector's **DVI-D** port, connect the end of your audio cable to the **Audio3** port.

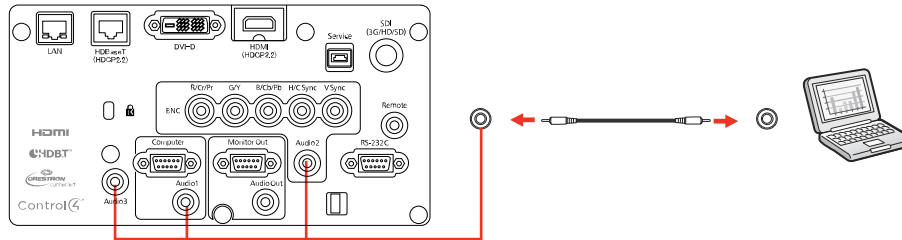

Parent topic: [Connecting to Computer Sources](#)

Related tasks

[Connecting to External Speakers](#)

Connecting to an HDBaseT Transmitter

To send an HDMI or RS-232C signal over a long distance, you can connect the projector to an optional HDBaseT transmitter using a 100Base-TX network cable. This is useful when you want to send a signal to or control the projector from a remote location, such as in a hall or event site, since you can use a network cable up to 328 feet (100 m) in length. To ensure proper data transmission, use a Category 5e STP cable or better.

1. Turn off the projector and HDBaseT transmitter.

Note: Make sure the projector and HDBaseT transmitter are turned off when connecting or disconnecting a network cable between the two devices.

2. Connect one end of the network cable to the **HDBaseT** port on the transmitter.

3. Connect the other end to the projector's **HDBaseT** port.

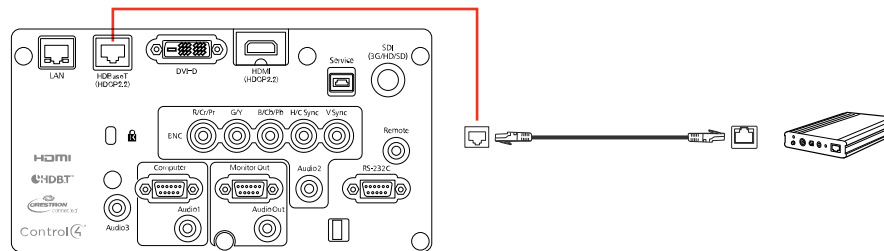

Note: See the documentation that came with the HDBaseT transmitter for instructions on connecting it to your video device or computer.

4. Turn on the projector and HDBaseT transmitter.

Note: To enable communication from the Ethernet and serial ports on the transmitter, select **On** as the **Control Communications** setting in the projector's Extended menu. Turning on this setting disables the projector's **LAN**, **RS-232C**, and **Remote** ports. If you connected an Extron XTP transmitter or switcher to the projector's **HDBaseT** port, select **On** as the **Extron XTP** setting in the projector's Extended menu.

Parent topic: [Projector Connections](#)

Related references

[Projector Setup Settings - Extended Menu](#)

Connecting to an External Computer Monitor

If you connected a computer to the projector's **Computer** or **BNC** port, you can also connect an external monitor to the projector. This lets you see your presentation on the external monitor even when the projected image is not visible.

If you want to output images to an external monitor when the projector is turned off, you need to select **Communication On** as the **Standby Mode** setting and **Always On** as the **A/V Output** setting in the projector's Extended menu.

Note: Monitors that use a refresh rate less than 60 Hz may not be able to display images correctly.

1. Make sure your computer is connected to the projector's **Computer** or **BNC** port.

2. Connect the external monitor's cable to your projector's **Monitor Out** port.

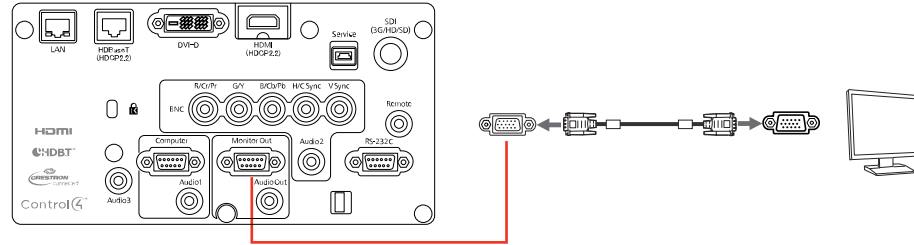

Note: If you do not see an image on the external monitor, you may need to change the **Monitor Out** setting in the Extended menu.

Parent topic: [Projector Connections](#)

Related references

[Projector Setup Settings - Extended Menu](#)

Connecting to External Speakers

To enhance the sound from your presentation, you can connect the projector to external self-powered speakers. You can control the volume using the projector's remote control.

You can also connect the projector to an amplifier with speakers.

If you want to output audio from the external speakers when the projector is turned off, you need to select **Communication On** for the **Standby Mode** setting and **Always On** for the **AV Output** setting in the projector's Extended menu.

Note: The projector's built-in speaker system (Pro L1100U/L11200U/L1300U) is disabled when you connect external speakers.

1. Make sure your computer or video source is connected to the projector with both audio and video cables as necessary.
2. Locate the appropriate cable to connect your external speakers, such as a stereo mini-jack-to-pin-jack cable, or another type of cable or adapter.
3. Connect one end of the cable to your external speakers as necessary.

4. Connect the stereo mini-jack end of the cable to your projector's **Audio Out** port.

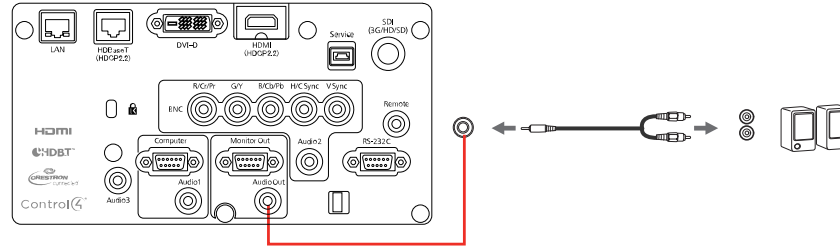

Parent topic: [Projector Connections](#)

Related references

[Projector Setup Settings - Extended Menu](#)

Attaching and Removing a Lens

Follow the instructions in these sections to attach or remove a compatible lens.

[Attaching a Lens](#)

[Removing a Lens](#)

Parent topic: [Setting Up the Projector](#)

Attaching a Lens

You can attach a compatible lens to the projector.

Caution: Unplug the power cord from the projector before attaching the lens. Avoid touching the lens with your bare hands to prevent fingerprints on or damage to the lens surface.

1. Pull the lens cover off of the projector.

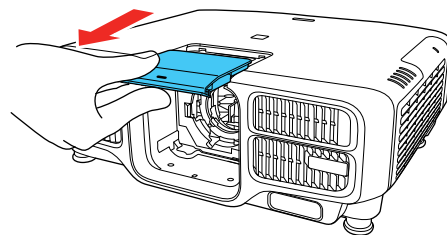

2. When using one of the following lenses, attach the lens connector cap: ELPLS04, ELPLU02, ELPLR04, ELPLW04, ELPLM06, ELPLM07, or ELPLL07.

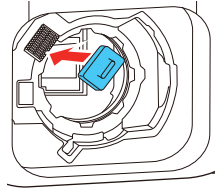

3. Slide the lock lever to the **Release** position (as shown) until you hear it click.

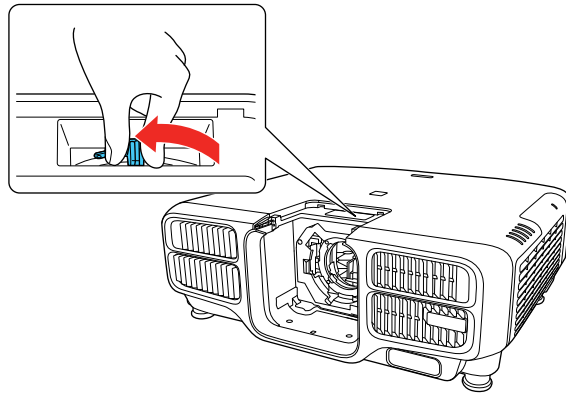

4. Insert the lens straight into the projector's lens socket with the white dot facing up.

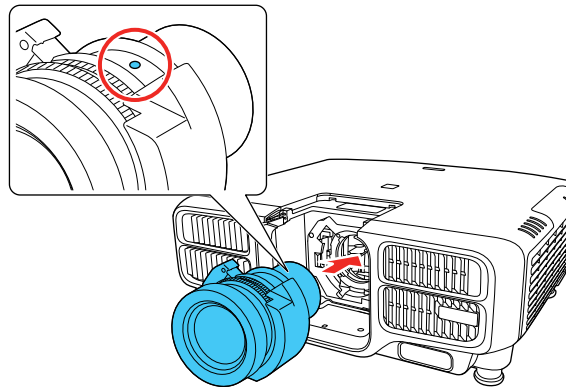

5. Hold the lens firmly and slide the lock lever to the **Lock** position (as shown) until it locks.

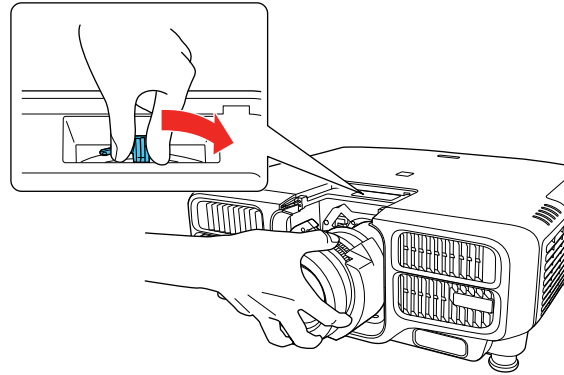

6. Replace the lens cover.

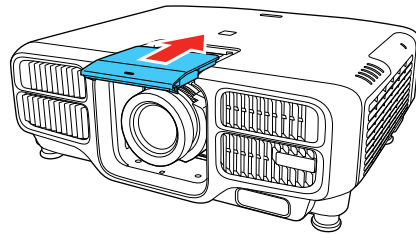

7. If prompted, select **Yes** to calibrate the lens.

Note: Lens calibration helps the projector to correctly acquire the lens position and adjustment range, and can take up to 100 seconds to complete. When calibration is finished, the lens returns to the same position it was in before calibration. (ELPX01 returns to the standard position.)

8. When using one of the following lenses, select the lens type in the **Extended** menu: ELPLS04, ELPLU02, ELPLR04, ELPLW04, ELPLM06, ELPLM07, or ELP LL07.

Parent topic: [Attaching and Removing a Lens](#)

Related tasks

[Setting the Lens Type](#)

Removing a Lens

You can remove a lens to replace it with a different lens.

Caution: Remove the lens only when necessary and make sure the front of the projector is not facing up when you remove the lens. This prevents dirt or dust from entering the projector and lowering the projection quality. Avoid touching the lens with your bare hands to prevent fingerprints on or damage to the lens surface.

1. Center the lens using the **Lens Shift** (remote) or **Lens** (control panel) button.
2. Turn off the projector and unplug the power cord.
3. Pull the lens cover off of the projector.

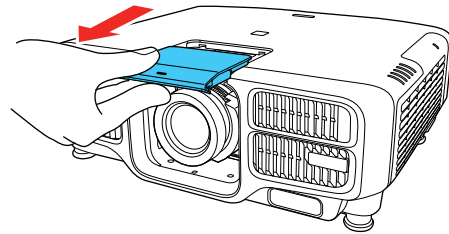

4. Hold the lens firmly as you slide the lock lever to the **Release** position (as shown) until you hear it click.

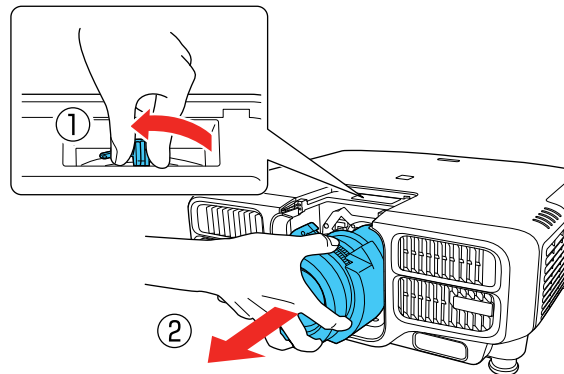

5. Gently pull the lens straight out of the projector.

Parent topic: [Attaching and Removing a Lens](#)

Attaching and Removing the Cable Cover

You can attach the cable cover that came with your projector to hide the attached cables from view.

1. Bundle the cables together using a band or other fastener (not provided).

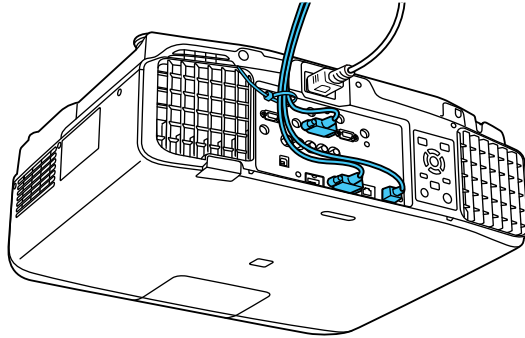

Caution: Do not bundle the power cord to the other cables. Otherwise, a fire may occur.

2. Place the cable cover on the projector as shown, guiding the cables through the notch on the base of the cable cover.

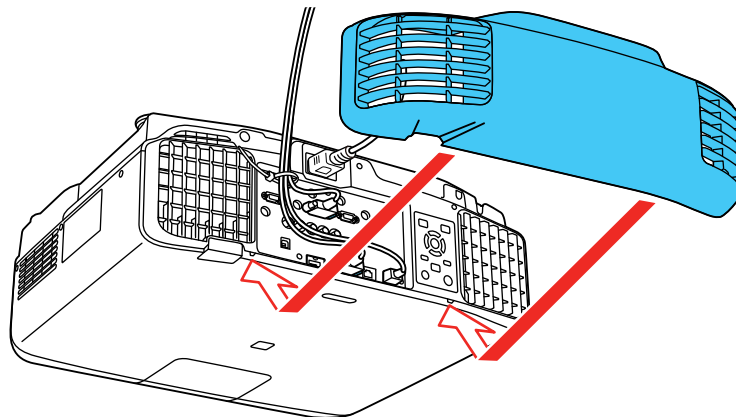

3. Tighten both cable cover screws.

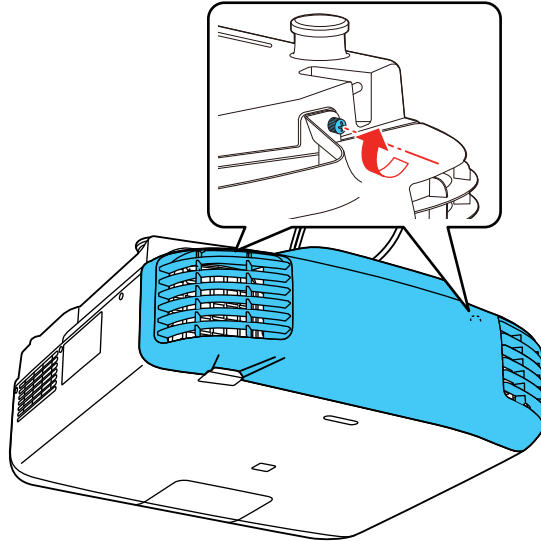

To remove the cover, loosen both screws and pull the cover off of the projector.

Parent topic: [Setting Up the Projector](#)

Attaching and Removing the Cable Clip

You can install the cable clip that came with your projector to provide additional support to the power cable (Pro L1405U/L1500U/L1505U).

1. Connect the power cable to the projector.
2. Insert the end of the cable clip anchor into the cable clip slot near the power inlet.

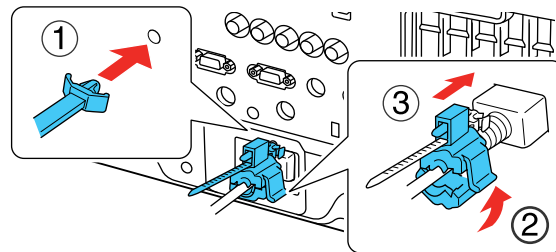

3. Place the open cable clip around the power cable, but don't lock it into place.
4. Slide the cable clip onto the anchor and lock the clip onto the power connector as shown.

To remove the cable clip, open the clip and disconnect the power cable. Then pinch the sides of the cable clip anchor and carefully remove it from the cable clip slot.

Parent topic: [Setting Up the Projector](#)

Installing Batteries in the Remote Control

The remote control uses the two AA batteries that came with the projector.

Caution: Use only the type of batteries specified in this manual. Do not install batteries of different types, or mix new and old batteries.

1. Remove the battery cover.

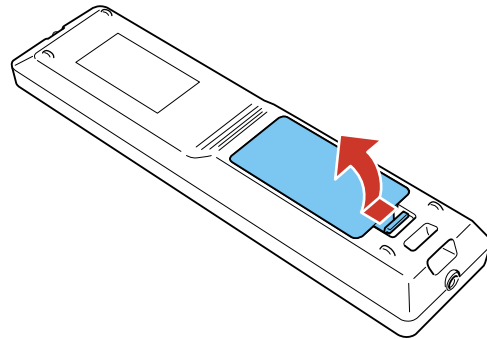

2. Insert the batteries with the + and – ends facing as shown.

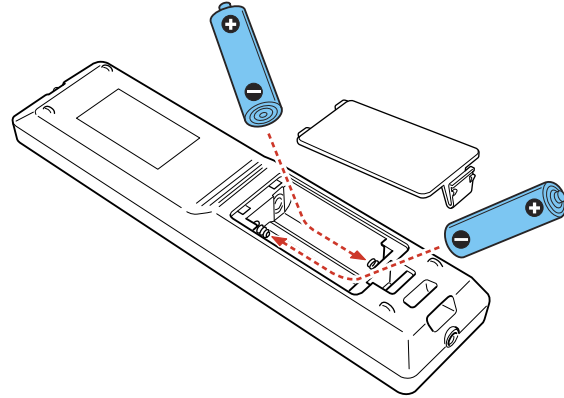

3. Replace the battery cover and press it down until it clicks into place.

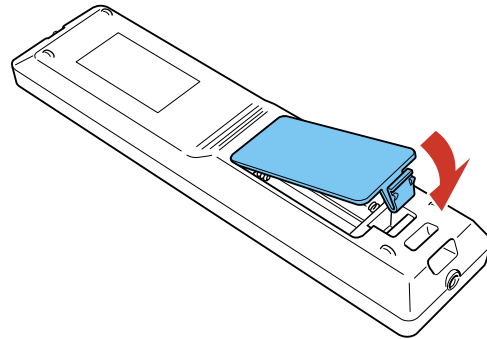

Warning: Dispose of used batteries according to local regulations. Do not expose batteries to heat or flame. Keep batteries out of the reach of children; they are choking hazards and are very dangerous if swallowed.

Parent topic: [Setting Up the Projector](#)

Using the Projector on a Network

Follow the instructions in these sections to set up your projector for use on a network.

[Wired Network Projection](#)

[Wireless Network Projection](#)

[Setting Up Projector Network E-Mail Alerts](#)

[Selecting Other Network Settings](#)

[Controlling a Networked Projector Using a Web Browser](#)

[Crestron RoomView Support](#)

Wired Network Projection

You can project through a wired network. To do this, you connect the projector to your network, and then set up your projector and computer for network projection.

After connecting and setting up the projector as described here, install the network software from the included CD or download the software and manuals as necessary.

Note: If your projector is connected via a LAN cable to a network that includes a wireless access point, you can connect to the projector wirelessly through the access point using the Epson network software.

[Connecting to a Wired Network](#)

[Selecting Wired Network Settings](#)

Parent topic: [Using the Projector on a Network](#)

Related references

[Additional Projector Software and Manuals](#)

Connecting to a Wired Network

To connect the projector to a wired local area network (LAN), use a 100Base-TX or 10Base-T network cable. To ensure proper data transmission, use a Category 5 shielded cable or better.

1. Connect one end of the network cable to your network hub, switch, or router.

2. Connect the other end of the cable to the projector's **LAN** port.

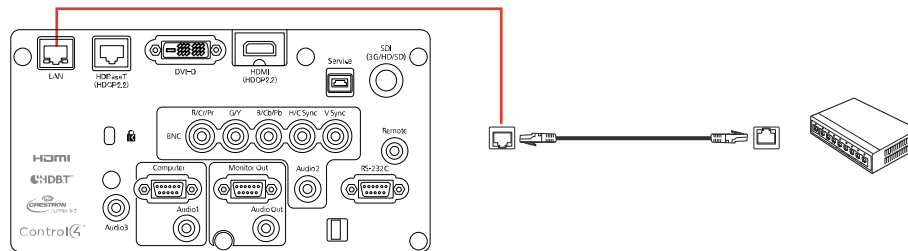

Parent topic: [Wired Network Projection](#)

Selecting Wired Network Settings

Before you can project from computers on your network, you must select the network settings for the projector using its menu system.

Note: Make sure you already connected the projector to your wired network using the **LAN** port.

1. Turn on the projector.
2. Press the **Menu** button.
3. Select the **Network** menu and press **Enter**.

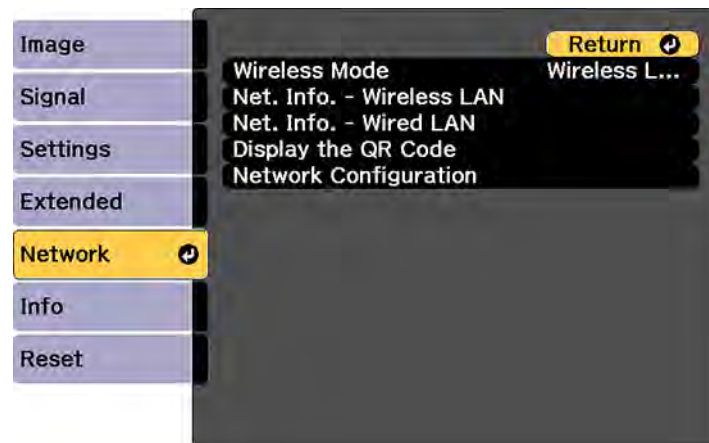

4. Select **Network Configuration** and press **Enter**.
5. Select the **Basic** menu and press **Enter**.

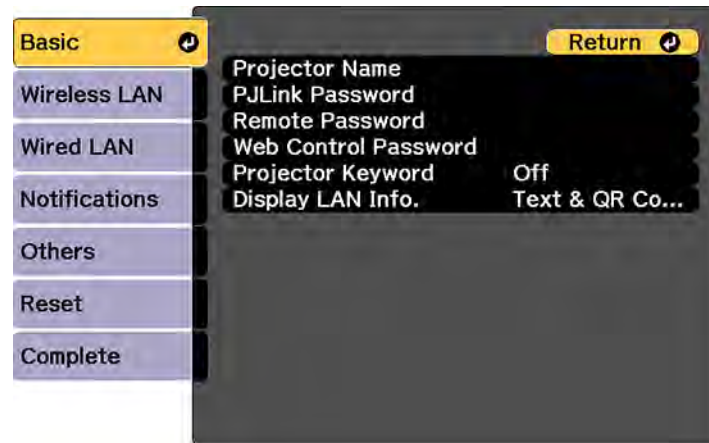

6. Select the following basic options as necessary:
 - **Projector Name** lets you enter a name up to 16 alphanumeric characters long to identify the projector over the network.
 - **PJLink Password** lets you enter a password up to 32 alphanumeric characters long for using the PJLink protocol for projector control.
 - **Remote Password** lets you enter a password up to 8 alphanumeric characters long for accessing the Remote or Basic Control screen in Epson Web Control. (Default user name is **EPSONREMOTE**; default password is **guest**.)
 - **Web Control Password** lets you enter a password up to 8 alphanumeric characters long for accessing Epson Web Control. (Default user name is **EPSONWEB**; default password is **admin**.)
 - **Projector Keyword** lets you turn on a security password to prevent access to the projector by anyone not in the room with it. You must enter a displayed, randomized keyword from a computer using the EasyMP Multi PC Projection software to access the projector.

- **Display LAN Info** lets you select how the projector displays network information. You can select an option to display a QR code that lets you quickly connect your iOS or Android devices using the Epson iProjection app.

Note: Use the displayed keyboard to enter the name, passwords and keyword. Press the arrow buttons on the remote control to highlight characters and press **Enter** to select them.

7. Select the **Wired LAN** menu and press **Enter**.

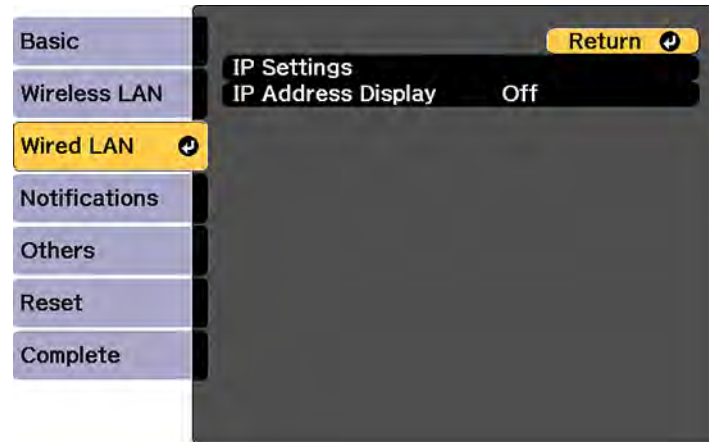

8. Select your IP Settings as necessary:
 - If your network assigns addresses automatically, turn on the **DHCP** setting.
 - If you must set addresses manually, turn off **DHCP** and enter the projector's **IP Address**, **Subnet Mask**, and **Gateway Address** as needed.

Note: To highlight the numbers you want from the displayed keyboard, press the arrow buttons on the remote control. To select a highlighted number, press **Enter**.

9. To prevent display of the IP address on the standby screen, turn off **IP Address Display**.
10. When you finish selecting settings, select **Complete** and follow the on-screen instructions to save your settings and exit the menus.

Parent topic: [Wired Network Projection](#)

Wireless Network Projection

You can project over a wireless network. To do this, you must set up your projector and computer for wireless projection.

Note: The Epson 802.11b/g/n wireless LAN module is not included with your projector and is optional.

There are two ways to connect to your projector wirelessly:

- Using the optional Quick Wireless Connection USB Key (Windows only); your computer does not need to be connected to a wireless network or use additional network software to connect with this option
- Configuring the connection manually using the projector's Network menus

After setting up the projector as described here, install the network software from the included CD or download the software and manuals as necessary.

Note: If your projector is connected via a LAN cable to a network that includes a wireless access point, you can connect to the projector wirelessly through the access point using the Epson network software.

[Installing the Wireless LAN Module](#)

[Using Quick Wireless Connection \(Windows Only\)](#)

[Selecting Wireless Network Settings Manually](#)

[Selecting Wireless Network Settings in OS X](#)

[Selecting Wireless Network Settings in Windows](#)

Parent topic: [Using the Projector on a Network](#)

Related references

[Additional Projector Software and Manuals](#)

[Optional Equipment and Replacement Parts](#)

Installing the Wireless LAN Module

To use the projector over a wireless network, install the optional Epson 802.11b/g/n wireless LAN module. Do not install any other type of wireless LAN module.

Caution: Never remove the module while its indicator light is green or flashing, or while you are projecting wirelessly. You may damage the module or lose data.

1. Turn off the projector and unplug the power cord.

2. Slide the air filter cover latch and open the air filter cover.

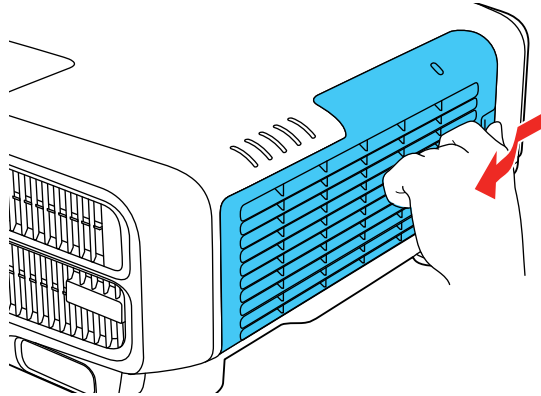

3. Remove the screw securing the wireless LAN module stopper, then remove the stopper.

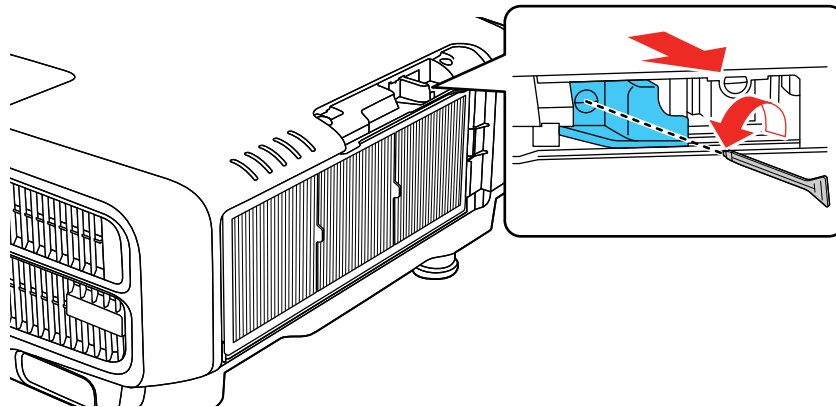

4. Insert the wireless LAN module into the port.

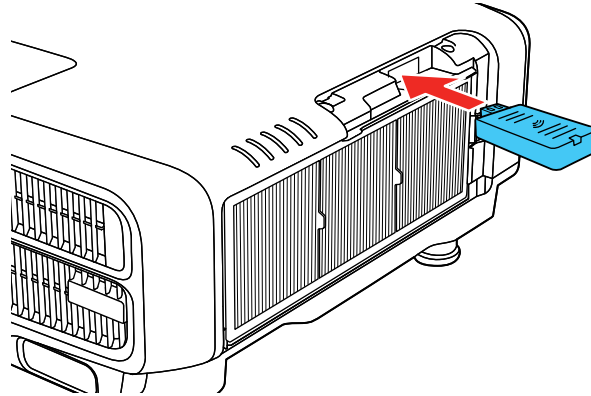

5. Replace the wireless LAN module stopper and secure it using the screw you removed.

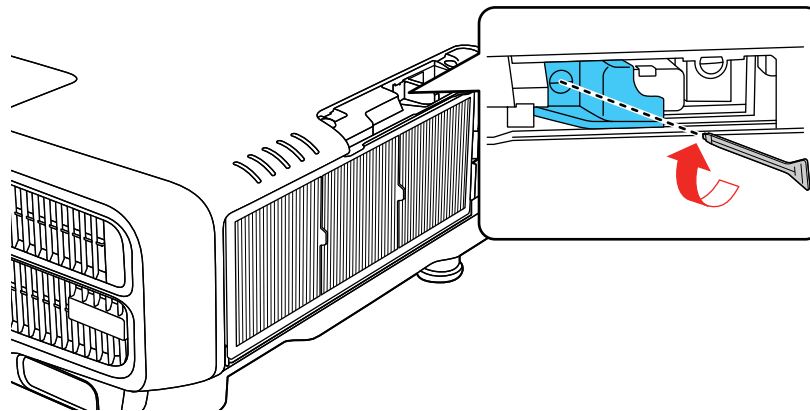

6. Close the air filter cover.
7. Plug in and turn on the projector.

Parent topic: [Wireless Network Projection](#)

Related references

[Optional Equipment and Replacement Parts](#)

Using Quick Wireless Connection (Windows Only)

You can use the Quick Wireless Connection USB key to quickly connect your computer to the projector wirelessly. Then you can project your presentation and remove the key when you are done.

Note: The Quick Wireless Connection USB key is not included with your projector and is optional.

Note: Make sure the wireless LAN module is installed. The wireless LAN module is not included with your projector and is optional.

1. Turn on the projector.
2. Press the **LAN** button on the remote control.

You see a screen like this:

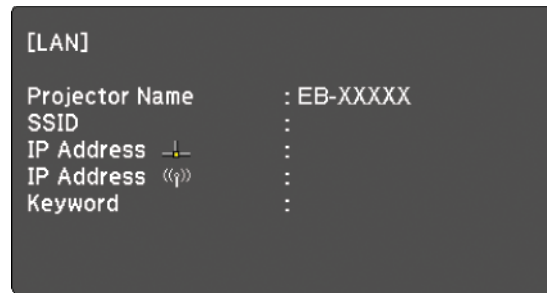

3. Verify that an SSID and IP address are displayed, then remove the wireless LAN module from the projector if necessary.

4. Insert the Quick Wireless Connection USB key into the same port used for the wireless LAN module.

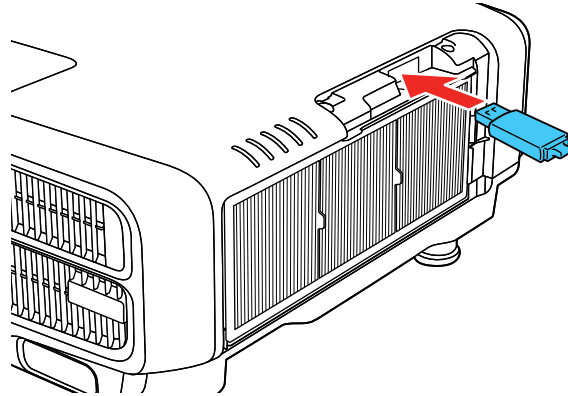

You see a projected message that the network information update is complete.

5. Remove the USB key.
6. Reinsert the wireless LAN module into the projector.
7. Connect the USB key to a USB port on your computer or laptop.

Note: In Windows Vista, if you see the AutoPlay window, select **Run LaunchQWRD.exe**, then select **Allow** on the next screen.

8. Follow the on-screen instructions to install the Quick Wireless Connection driver.

Note: If you see a Windows Firewall message, click **Yes** to disable the firewall for this application.

After a few minutes, your computer image is displayed by the projector. If it does not appear, press the **LAN** button on your remote control or restart your computer.

9. Run your presentation as necessary.
10. When you finish projecting wirelessly, select the **Safely Remove Hardware** option in the Windows taskbar, then remove the USB key from your computer.

Note: You may need to restart your computer to reactivate your wireless LAN connection.

Parent topic: [Wireless Network Projection](#)

Related references

[Optional Equipment and Replacement Parts](#)

Selecting Wireless Network Settings Manually

Before you can project from your wireless network, you must select the network settings for the projector using its menu system.

1. Turn on the projector.
2. Press the **Menu** button.
3. Select the **Network** menu and press **Enter**.

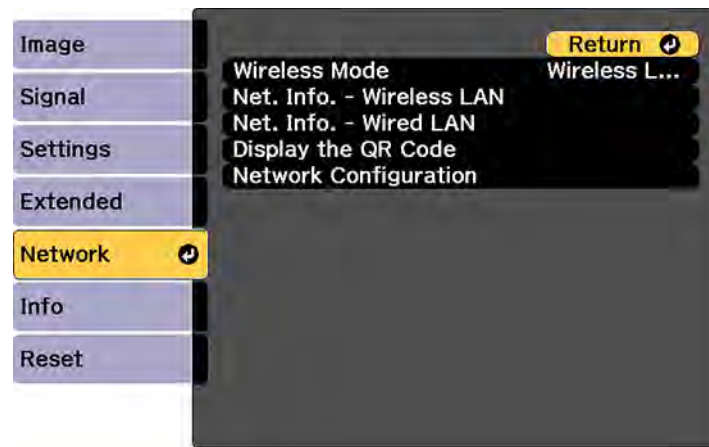

4. Make sure the **Wireless Mode** setting is set to **Wireless LAN On**.
5. Select **Network Configuration** and press **Enter**.

6. Select the **Basic** menu and press **Enter**.

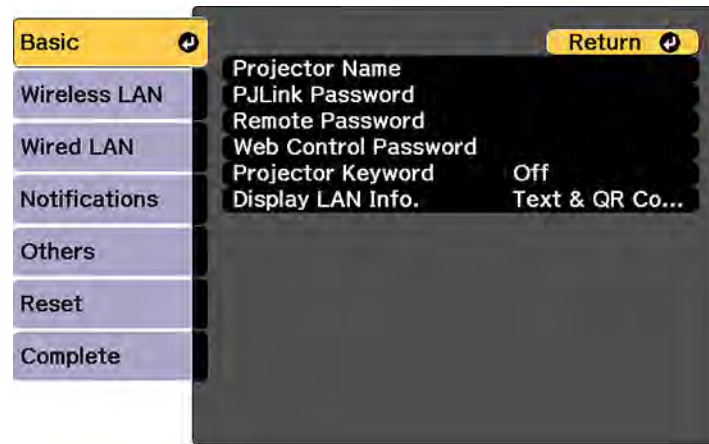

7. Select the following basic options as necessary:

- **Projector Name** lets you enter a name up to 16 alphanumeric characters long to identify the projector over the network.
- **PJLink Password** lets you enter a password up to 32 alphanumeric characters long for using the PJLink protocol for projector control.
- **Remote Password** lets you enter a password up to 8 alphanumeric characters long for accessing the Remote or Basic Control screen in the Epson Web Control. (Default user name is **EPSONREMOTE**; default password is **guest**.)
- **Web Control Password** lets you enter a password up to 8 alphanumeric characters long for accessing the projector over the web. (Default user name is **EPSONWEB**; default password is **admin**.)
- **Projector Keyword** lets you turn on a security password to prevent access to the projector by anyone not in the room with it. You must enter a displayed, randomized keyword from a computer using the EasyMP Multi PC Projection software to access the projector.
- **Display LAN Info** lets you select how the projector displays network information. You can select an option to display a QR code that lets you quickly connect your iOS or Android devices using the Epson iProjection app.

Note: Use the displayed keyboard to enter the name, passwords and keyword. Press the arrow buttons on the remote control to highlight characters and press **Enter** to select them.

8. Select the **Wireless LAN** menu and press **Enter**.

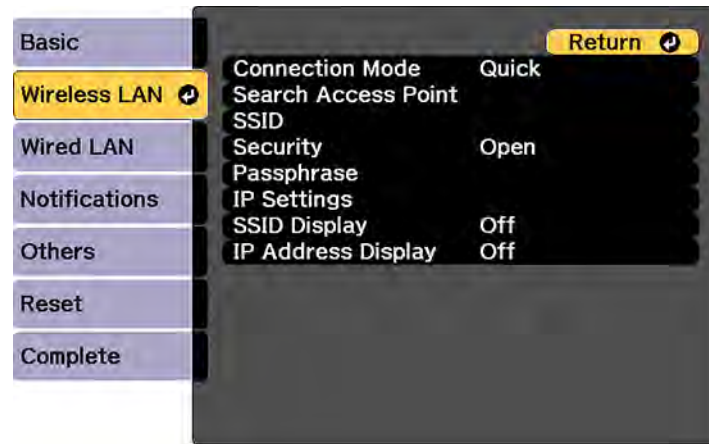

9. Select the settings on the **Wireless LAN** menu as necessary for your network.
10. When you finish selecting settings, select **Complete** and follow the on-screen instructions to save your settings and exit the menus.

After you complete the wireless settings for your projector, you need to select the wireless network on your computer, or iOS or Android device.

[Wireless LAN Menu Settings](#)

Parent topic: [Wireless Network Projection](#)

Wireless LAN Menu Settings

Setting	Options	Description
Connection Mode	Quick Advanced	Selects the type of wireless connection: Quick: lets you quickly connect to one computer or use the optional Quick Wireless Connection USB key to connect Advanced: lets you connect to multiple computers via a wireless network access point (infrastructure mode)
Search Access Point	To Search View	Search for available wireless network access points in Advanced connection mode
SSID	Up 32 alphanumeric characters	Sets the SSID (network name) of the wireless LAN system the projector is connecting to
Security	Open WPA2-PSK WPA/WPA2-PSK	Selects the type of wireless security used in the wireless network
Passphrase	Between 8 to 63 alphanumeric characters	Enter a paraphrase for the wireless network
Channel	1ch 6ch 11ch	In Quick connection mode, selects the frequency band (channel) used by the wireless LAN
IP Settings	—	Turns on DHCP if your network assigns addresses automatically; set to Off to manually enter the network's IP Address , Subnet Mask , and Gateway Address

Setting	Options	Description
SSID Display	On Off	Selects whether to display the SSID on the network standby screen
IP Address Display	On Off	Selects whether to display the IP address on the network standby screen

Parent topic: [Selecting Wireless Network Settings Manually](#)

Selecting Wireless Network Settings in OS X

Before connecting to the projector, select the correct wireless network in OS X.

1. Click the AirPort icon on the menu bar at the top of the screen.
2. Make sure AirPort is turned on, then do one of the following:
 - If your projector is set up on an existing network (Advanced mode), select the network name (SSID).
 - If your projector is configured for Quick mode, select the projector's SSID.

Parent topic: [Wireless Network Projection](#)

Selecting Wireless Network Settings in Windows

Before connecting to the projector, select the correct wireless network on your computer.

1. To access your wireless utility software, access the Desktop and double-click the network icon on the Windows taskbar.
2. Do one of the following:
 - If your projector is set up on an existing network (Advanced mode), select the network name (SSID).
 - If your projector is configured for Quick mode, select the projector's SSID.
3. Click **Connect**.

Parent topic: [Wireless Network Projection](#)

Setting Up Projector Network E-Mail Alerts

You can set up the projector to send you an e-mail alert over the network if there is a problem with the projector.

1. Press the **Menu** button.
2. Select the **Network** menu and press **Enter**.
3. Select **Network Configuration** and press **Enter**.
4. Select the **Notifications** menu and press **Enter**.

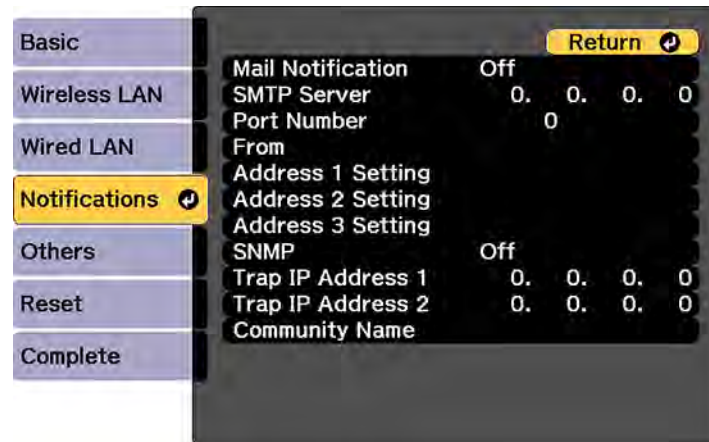

5. Turn on **Mail Notification**.
6. Enter the IP address for the **SMTP Server** setting.

Note: To enter the IP address using the numeric keys on the remote control, press and hold the **Num** button. Do not use these addresses: 127.x.x.x or 224.0.0.0 through 255.255.255.255 (where x is a number from 0 to 255).

7. Select a number for the SMTP server **Port Number** setting, from 1 to 65535 (default is 25).
8. Choose an **Address** field, enter the e-mail address, and select the alerts you want to receive there. Repeat for up to three addresses. Your e-mail address can be up to 32 alphanumeric characters long.

9. When you finish selecting settings, select **Complete** and follow the on-screen instructions to save your settings and exit the menus.

Note: If a critical problem causes a projector to shut down, you may not receive an e-mail alert.

[Network Projector E-mail Alert Messages](#)

Parent topic: [Using the Projector on a Network](#)

Network Projector E-mail Alert Messages

When a problem occurs with a networked projector, and you selected to receive e-mail alerts, you receive an e-mail containing the following information:

- **Epson Projector** on the subject line
- The name of the projector experiencing a problem
- The IP address of the affected projector
- Detailed information about the problem

Note: If a critical problem causes a projector to shut down, you may not receive an e-mail alert.

Parent topic: [Setting Up Projector Network E-Mail Alerts](#)

Selecting Other Network Settings

You can select optional network settings on the Others menu.

1. Press the **Menu** button.
2. Select the **Network** menu and press **Enter**.
3. Select **Network Configuration** and press **Enter**.

4. Select the **Others** menu and press **Enter**.

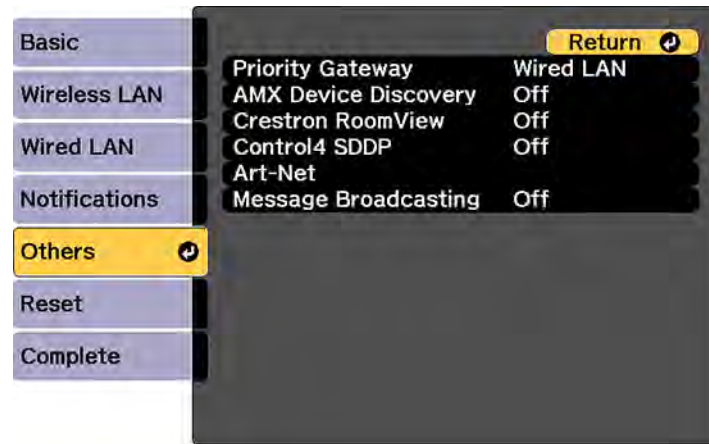

5. If available, select the **Priority Gateway** setting for your network.
6. If your network environment uses an AMX controller, turn on the **AMX Device Discovery** setting to allow the projector to be detected.
7. If your network environment uses a Crestron RoomView controller, turn on the **Crestron RoomView** setting to allow the projector to be detected.

Note: Enabling Crestron RoomView disables the Epson Message Broadcast feature in the EasyMP Monitor software.

8. If your network environment uses a Control4 or Control4 SDDP controller, turn on the **Control4 SDDP** setting to allow the projector to be detected.
9. If you want to control the projector using Art-Net (an Ethernet communication protocol based on TCP/IP), turn on the **Art-Net** setting (Pro L1405U/L1500U/L1505U).
10. If you want this projector to receive broadcasted messages over the network, turn on the **Message Broadcasting** setting. Administrators can broadcast messages over the network using the Message Broadcasting plug-in for EasyMP Monitor (Windows only).
11. When you finish selecting settings, select **Complete** and follow the on-screen instructions to save your settings and exit the menus.

Parent topic: [Using the Projector on a Network](#)

Controlling a Networked Projector Using a Web Browser

Once you have connected your projector to your network, you can select projector settings and control projection using a compatible web browser. This lets you access the projector remotely.

Note: The web setup and control features support Microsoft Internet Explorer 9.0 or later, and Safari on networks that do not use a proxy server for connection. You cannot select all of the projector menu settings or control all projector functions using a web browser.

Note: If you set Standby Mode to **Communication On**, you can use a web browser to select settings and control projection even if the projector is in standby mode.

1. Make sure the projector is turned on.
2. Start your web browser on a computer or device connected to the network.
3. Type the projector's IP address into the browser's address box and press the computer's **Enter** key.

Note: You may need to log in before you see the Web Control screen. If you see a log in window, enter your user name and password. (The default user name is **EPSONWEB** and the default password is **admin**.)

You see the Web Control screen.



- 1 Select **Basic Control** to control the projector remotely
- 2 Select **OSD Control Pad** to change the projector's menu settings

- 3 Select **Test Pattern** to display a test pattern
 - 4 Select **Advanced** to open the advanced menu screen
 - 5 Select **Status Information** to view the projector's status
 - 6 Select **Lens Control** to adjust the lens (focus, zoom, and lens shift)
4. Select the option corresponding to the projector function you want to control.

Web Control Options

Parent topic: [Using the Projector on a Network](#)

Related references

[Projector Setup Settings - Extended Menu](#)

Web Control Options

Basic Control

Note: If the Remote Password is set to **On**, you need to enter your user name and password. (The default username is **EPSONREMOTE** and the default password is **guest**).

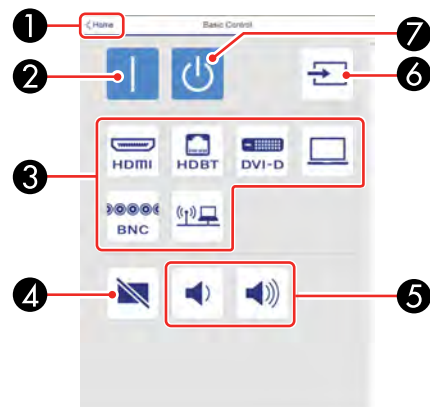

- 1 Returns to the Home screen
- 2 Turns on the projector

- 3 Input source selection controls
- 4 **A/V Mute** button control
- 5 **Volume** button controls
- 6 Searches for sources
- 7 Turns off the projector

OSD Control Pad

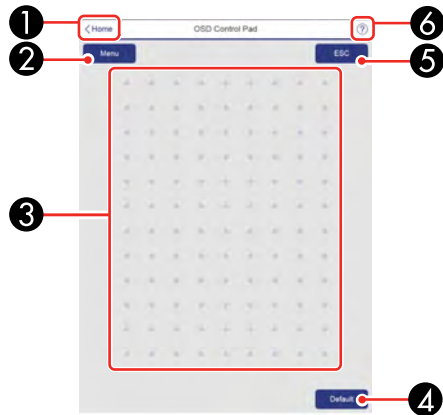

- 1 Returns to the Home screen
- 2 Displays the projector's setting menus
- 3 Use your finger or mouse to navigate the menus
- 4 Returns settings to their default values
- 5 Returns to the previous menu
- 6 Displays help topics

Note: You cannot change some settings using Epson Web Control.

Lens Control

Focus/Distortion screen

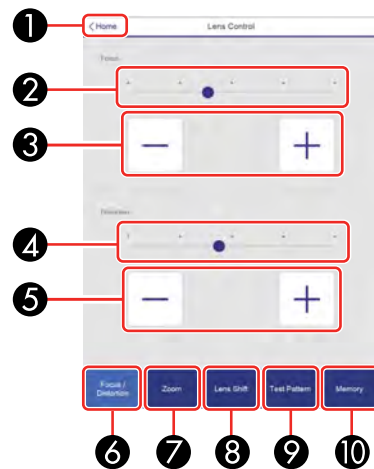

- 1 Returns to the Home screen
- 2 Focus adjustment slider
- 3 Focus adjustment buttons
- 4 Distortion adjustment slider (not available for ELPLU02)
- 5 Distortion adjustment buttons (not available for ELPLU02)
- 6 Displays the Focus/Distortion screen
- 7 Displays the Zoom screen
- 8 Displays the Lens Shift screen
- 9 Displays the Test Pattern screen
- 10 Displays the Memory screen

Zoom screen

Note: Zoom is not available for ELPLX01 and ELPLR04.

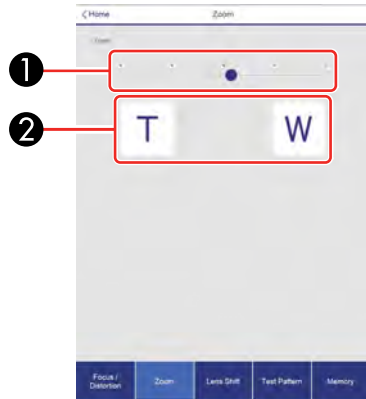

- 1 Zoom adjustment slider
- 2 Zoom adjustment buttons

Lens Shift screen

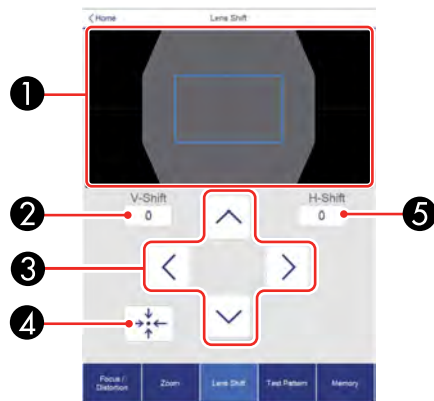

- 1 The current image position is displayed as a blue square and the new image position is displayed as a red square

- 2 Displays the vertical image position; select to change the value
- 3 Moves the image position up, down, left, or right
- 4 Moves the lens to the home position
- 5 Displays the horizontal image position; select to change the value

Test Pattern screen

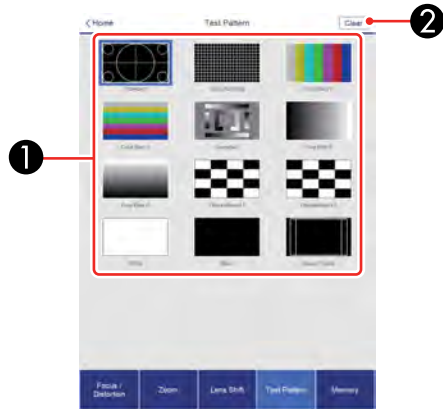

- 1 Displays available test patterns; select to project a test pattern
- 2 Turns off test pattern display

Memory screen



- 1 Overwrites your current settings with saved settings
- 2 Saves your current settings to memory
- 3 Displays a list of saved memories
- 4 Erases a saved memory
- 5 Renames a saved memory

Status Information



- 1 Returns to the Home screen
- 2 Displays a list of monitored items
- 3 Displays the item status
- 4 Select to view different status information

Parent topic: [Controlling a Networked Projector Using a Web Browser](#)

Crestron RoomView Support

If you are using the Crestron RoomView network monitoring and control system, you can set up your projector for use on the system. Crestron RoomView lets you control and monitor your projector using a web browser.

Note: You cannot use the Epson Web Control feature or the Message Broadcasting plug-in for EasyMP Monitor when you use Crestron RoomView.

For additional information on Crestron RoomView, contact Crestron.

[Setting Up Crestron RoomView Support](#)

[Controlling a Networked Projector Using Crestron RoomView](#)

Parent topic: [Using the Projector on a Network](#)

Setting Up Crestron RoomView Support

To set up your projector for monitoring and control using a Crestron RoomView system, make sure your computer and projector are connected to the network.

Note: If you want to use the Crestron RoomView system when the projector is turned off, you need to adjust the **Standby Mode** settings in the Extended menu.

1. Press the **Menu** button.
2. Select the **Network** menu and press **Enter**.
3. Select **Network Configuration** and press **Enter**.

4. Select the **Others** menu and press **Enter**.

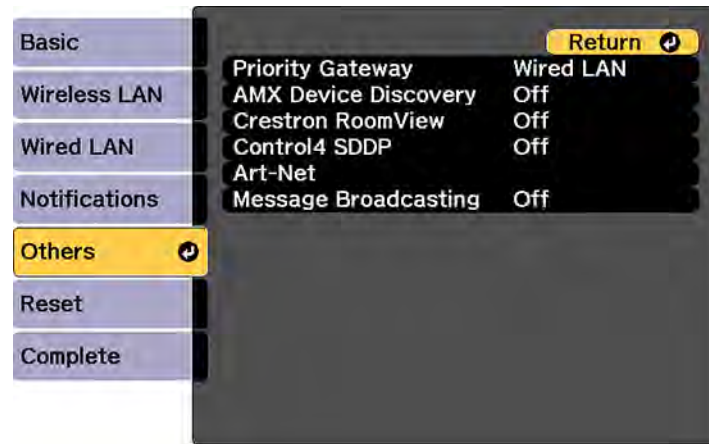

5. Set the **Crestron RoomView** setting to **On** to allow the projector to be detected.

Note: Enabling Crestron RoomView disables the Epson Message Broadcasting feature in the EasyMP Monitor software.

6. When you finish selecting settings, select **Complete** and follow the on-screen instructions to save your settings and exit the menus.
7. Turn off the projector, then turn it on again to enable the setting.

Parent topic: [Crestron RoomView Support](#)

Related references

[Projector Setup Settings - Extended Menu](#)

Controlling a Networked Projector Using Crestron RoomView

Once you have set up your projector to use Crestron RoomView, you can control and monitor projection using a compatible web browser.

1. Start your web browser on a computer connected to the network.
2. Type the projector's IP address into the browser's address box and press the computer's **Enter** key.

You see this screen:



3. Select the input source that you want to control in the Sources List box. You can scroll through available sources using the up and down arrows in the box.
4. To control projection remotely, click the on-screen buttons that correspond to the projector's remote control buttons. You can scroll through button options at the bottom of the screen.

Note: These on-screen buttons do not directly correspond to the projector's remote control buttons:

- **OK** acts as the **Enter** button
- **Menu** displays the projector's menu

5. To view information about the projector, click the **Info** tab.
6. To change projector, Crestron, and password settings, click the **Tools** tab, select settings on the displayed screen, and click **Send**.
7. When you finish selecting settings, click **Exit** to exit the program.

Parent topic: [Crestron RoomView Support](#)

Using Basic Projector Features

Follow the instructions in these sections to use your projector's basic features.

[Turning On the Projector](#)

[Turning Off the Projector](#)

[Selecting the Language for the Projector Menus](#)

[Resizing the Image with the Zoom Button](#)

[Focusing the Image Using the Focus Button](#)

[Setting the Lens Type](#)

[Setting the Screen Type](#)

[Adjusting the Image Position Using Lens Shift](#)

[Adjusting the Image Position Using Screen Position](#)

[Displaying a Test Pattern](#)

[Adjusting the Image Height](#)

[Image Shape](#)

[Selecting an Image Source](#)

[Remote Control Operation](#)

[Projection Modes](#)

[Image Aspect Ratio](#)

[Color Mode](#)

[Adjusting the Brightness](#)

[Turning On Automatic Luminance Adjustment](#)

[Controlling the Volume with the Volume Buttons](#)

[Setting the Date and Time](#)

Turning On the Projector

Turn on the computer or video equipment you want to use before you turn on the projector so it can display the image source.

1. Connect the power cord to the projector's power inlet.

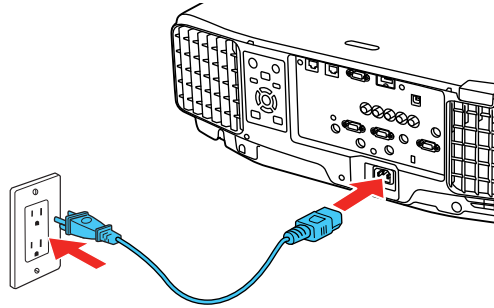

2. Plug the power cord into an electrical outlet.
The projector's On/Standby light turns blue. This indicates that the projector is receiving power.

Note: With **Direct Power On** turned on, the projector turns on as soon as you plug it in.

3. Press the **On** button on the projector or remote control to turn on the projector.
The projector beeps and the Status light flashes blue as the projector warms up. After about 30 seconds, the Status light stops flashing and turns blue.

Warning: Never look into the projector lens when the laser is on. This can damage your eyes and is especially dangerous for children and pets.

Caution: Make sure no objects are blocking the light from the projector lens. Objects blocking the lens for an extended time can melt and light that is reflected back into the lens can cause the projector to malfunction.

Note: If the **Auto Source Search** setting in the Extended menu is enabled, the projector automatically detects the input signal when you turn it on.

If you do not see a projected image right away, try the following:

- Make sure the lens cap is off.
- Turn on the connected computer or video device.
- Insert a DVD or other video media and press the play button, if necessary.

- Press the **Source Search** button on the projector or the **Search** button on the remote control to detect the video source.
- If the Home screen is displayed, select the source you want to project.

Using the Home Screen

Parent topic: [Using Basic Projector Features](#)

Related references

[Projector Setup Settings - Extended Menu](#)

Related tasks

[Turning Off the Projector](#)

Using the Home Screen

You can select input sources and other frequently used options from the Home screen.

1. To display the Home screen, do one of the following:
 - Press the **Home** button on the remote control.
 - Turn on the projector with the **Home Screen Auto Disp** setting enabled.
 - Turn on the projector when no signal is received from the selected input source.
2. Press the arrow buttons on the remote control or control panel to navigate the screen, and press **Enter** to select an option.

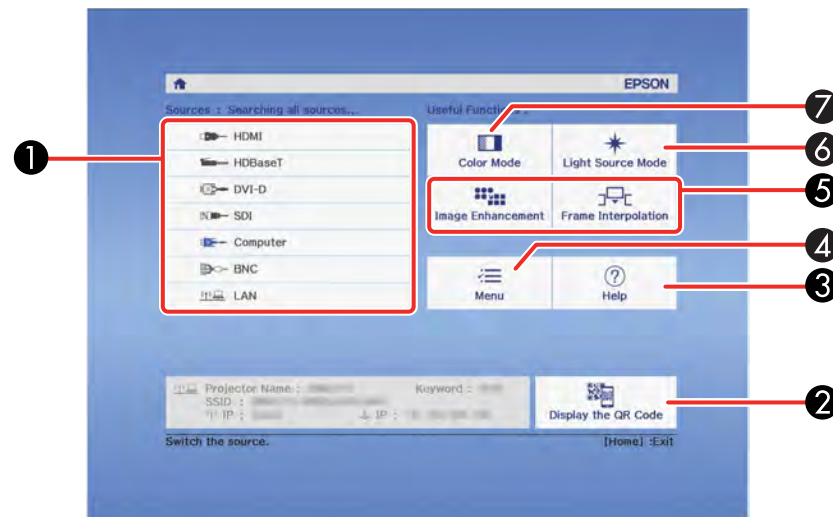

- 1 Select the video source you want to project
- 2 Display the QR code
- 3 Display the Help screen
- 4 Display the projector's menus
- 5 Select customizable menu options
- 6 Select to change the Light Source Mode
- 7 Select to change the Color Mode

Note: You can select the customizable menu options using the **Custom Function 1** and **Custom Function 2** settings in the Extended menu.

3. Press the **Home** button to hide the Home screen.

Parent topic: [Turning On the Projector](#)

Related references

[Projector Setup Settings - Extended Menu](#)

Turning Off the Projector

Before turning off the projector, shut down any computer connected to it so you can see the computer display during shutdown.

Note: Turn off this product when not in use to prolong the life of the projector. Laser life will vary depending upon mode selected, environmental conditions, and usage. Brightness decreases over time.

Note: When using the A/V Mute feature, the laser is still on. To turn off the laser, turn off the projector.

1. Press the **Standby** button on the projector or remote control.

The projector displays a shutdown confirmation screen.

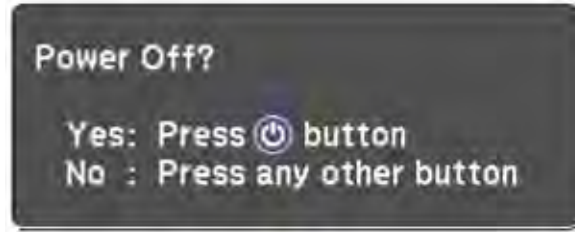

2. Press the **Standby** button on the projector or remote control again. (To leave it on, press any other button.)

The projector beeps twice, the laser turns off, and the Status light turns off.

Note: With Epson's Instant Off technology, there is no cool-down period so you can pack up the projector for transport right away (if necessary).

3. To transport or store the projector, make sure the Status light is off, then unplug the power cord.

Note: If you use the projector continuously for more than 24 hours, or regularly turn it off by shutting off the power outlet, schedule periodic **Light Source Calibration** events from the Extended menu.

Parent topic: [Using Basic Projector Features](#)

Related references

[Projector Setup Settings - Extended Menu](#)

Related tasks

[Turning On the Projector](#)

[Saving a Scheduled Event](#)

Selecting the Language for the Projector Menus

If you want to view the projector's menus and messages in another language, you can change the Language setting.

1. Turn on the projector.
2. Press the **Menu** button.

3. Select the **Extended** menu and press **Enter**.

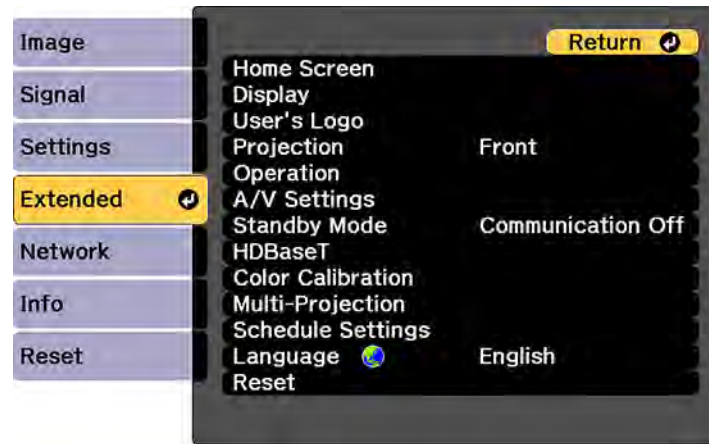

4. Select the **Language** setting and press **Enter**.
5. Select the language you want to use and press **Enter**.
6. Press **Menu** or **Esc** to exit the menus.

Parent topic: [Using Basic Projector Features](#)

Resizing the Image with the Zoom Button

You can adjust the size of the image using the zoom buttons.

Note: Wait 20 minutes after turning on the projector before setting the focus, zoom, and lens shift for maximum accuracy.

1. Turn on the projector and display an image.

2. Press the **Lens** button on the control panel repeatedly until the zoom adjustment screen appears, or press the **Zoom** button on the remote control.

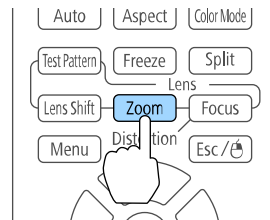
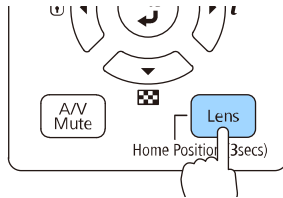

3. Press and hold the arrow buttons on the projector's control panel or remote control to resize the image.
4. Press the **Esc** button on the projector's control panel or remote control when finished.

Parent topic: [Using Basic Projector Features](#)

Focusing the Image Using the Focus Button

You can adjust the sharpness of the projected image using the focus buttons.

Note: Wait 20 minutes after turning on the projector before setting the focus, zoom, and lens shift for maximum accuracy. If you installed any of the following lenses, see the section on focusing with a short throw lens instead: ELPLX01, ELPLU03, ELPLU04, ELPLW05, or ELPLU02.

1. Turn on the projector and display an image.

2. Press the **Lens** button on the control panel repeatedly until the focus adjustment screen appears, or press the **Focus** button on the remote control.

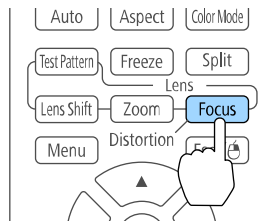
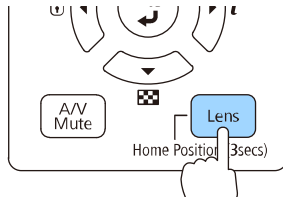

3. Press and hold the arrow buttons on the projector's control panel or remote control to adjust the focus.
4. Press the **Esc** button on the projector's control panel or remote control when finished.

[Focusing the Image with an Optional Short Throw Lens](#)

Parent topic: [Using Basic Projector Features](#)

Related tasks

[Focusing the Image with an Optional Short Throw Lens](#)

Focusing the Image with an Optional Short Throw Lens

If you installed an optional short throw lens (ELPLX01/ELPLU03/ELPLU04/ELPLW05/ELPLU02), you may need to focus on the center of your screen and then correct any distortion in the surrounding area.

1. Turn on the projector and display an image.
2. Press the **Focus** button on the remote control or press the **Lens** button on the control panel repeatedly until the focus adjustment screen appears.

3. Press the left or right arrow buttons until the center of the image is focused.

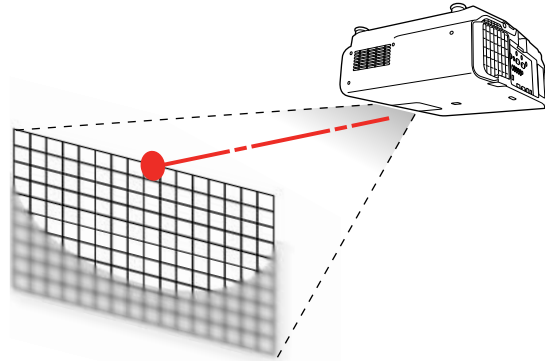

4. Press the **Focus** button on the remote control or press the **Lens** button on the control panel repeatedly until the distortion adjustment screen appears.
5. Press the left or right arrow buttons until the edges of the image are also focused.

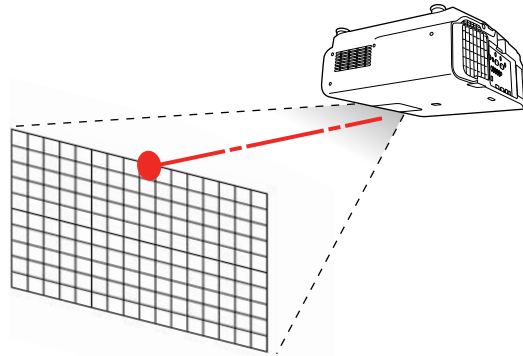

Note: If you installed the optional ELPLU02 short throw lens and you see a message prompting you to manually adjust the image distortion, manually rotate the distortion ring counterclockwise. Adjust the focus and then rotate the distortion ring to correct image distortion.

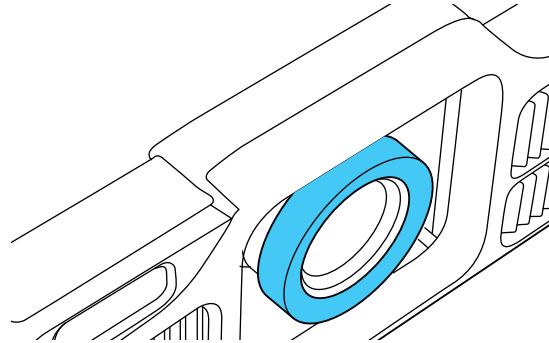

Parent topic: [Focusing the Image Using the Focus Button](#)

Setting the Lens Type

After installing one of the following lenses, you need to select the model number for the lens: ELPLS04, ELPLU02, ELPLR04, ELPLW04, ELPLM06, ELPLM07, or ELPLL07.

1. Turn on the projector and display an image.
2. Press the **Menu** button.
3. Select the **Extended** menu and press **Enter**.
4. Select **Operation > Advanced > Lens Type**.
5. Select your lens model number and press **Enter**.
6. Press the **Menu** button to exit.

Parent topic: [Using Basic Projector Features](#)

Setting the Screen Type

You can use the Screen Type setting to match the aspect ratio of the displayed image to the screen you are using.

1. Turn on the projector and display an image.
2. Press the **Menu** button.

3. Select the **Extended** menu and press **Enter**.
4. Select **Display > Screen > Screen Type**.

You see this screen:

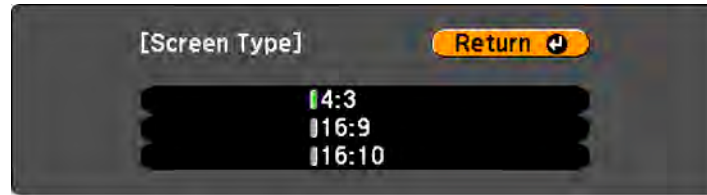

5. Select your screen's aspect ratio and press **Enter**.
6. Press the **Menu** button to exit.
7. Adjust the aspect ratio for the projected image, if necessary.

Parent topic: [Using Basic Projector Features](#)

Related concepts

[Image Aspect Ratio](#)

Adjusting the Image Position Using Lens Shift

If you cannot install the projector directly in front of the screen, you can adjust the position of the projected image using the lens shift feature.

Note: Wait 20 minutes after turning on the projector before setting the focus, zoom, and lens shift for maximum accuracy. Lens shift is not supported for the ELPLR04 lens.

1. Turn on the projector and display an image.

2. Press the **Lens Shift** button on the remote control or the **Lens** button on the control panel.
3. Press the arrow buttons to adjust the position of the projected image as necessary.

Pro L1100U/L1200U/L1300U/L1405U - ELPLU03, ELPLU04, ELPLW05, ELPLW06, ELPLM08, ELPLM09, ELPLM10, ELPLM11, or ELPLL08 lens

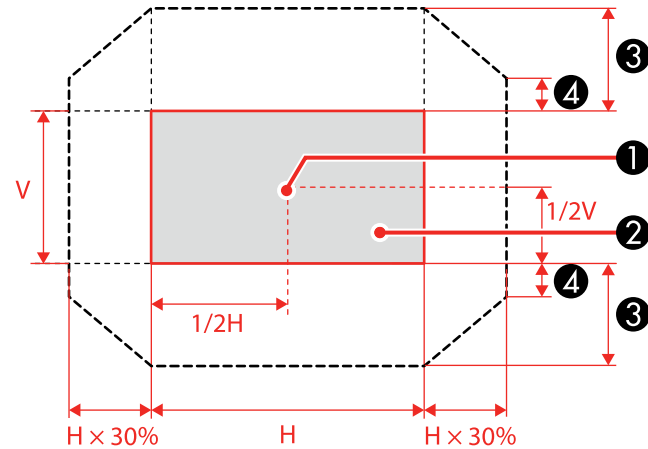

- 1 Center of lens
- 2 Projected image when lens shift is set to the home position
- 3 Maximum range: $V \times 67\%$; maximum range when performing screen matching: $V \times 44\%$ (ELPLU03), $V \times 51\%$ (ELPLM09)
- 4 Maximum range when the lens is shifted horizontally all the way: $V \times 19\%$; maximum range when performing screen matching: $V \times 64\%$ (ELPLU03)

Pro L1100U/L1200U/L1300U/L1405U - ELPLX01 lens

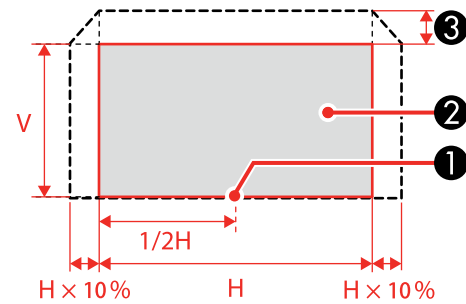

- 1 Center of lens
- 2 Projected image when lens shift is set to the home position
- 3 Maximum range: $V \times 17\%$

Note: You cannot move the image upward when the lens is shifted horizontally all the way.

Pro L1500U/L1505U - ELPLU03 or ELPLW05 lens

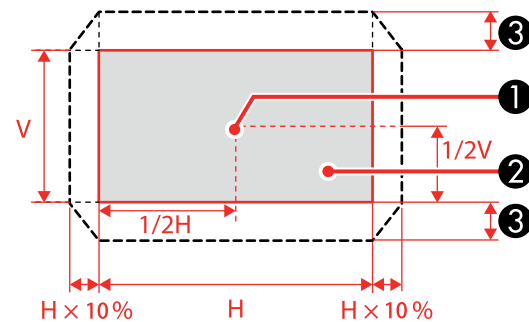

- 1 Center of lens
- 2 Projected image when lens shift is set to the home position
- 3 Maximum range: $V \times 24\%$; maximum range when performing screen matching: $V \times 11\%$ (ELPLU03)

Note: You cannot move the image upward when the lens is shifted horizontally all the way.

Pro L1500U/L1505U - ELPLU04, ELPLW06, ELPLM09, ELPLM10, ELPLM11, or ELPLL08 lens

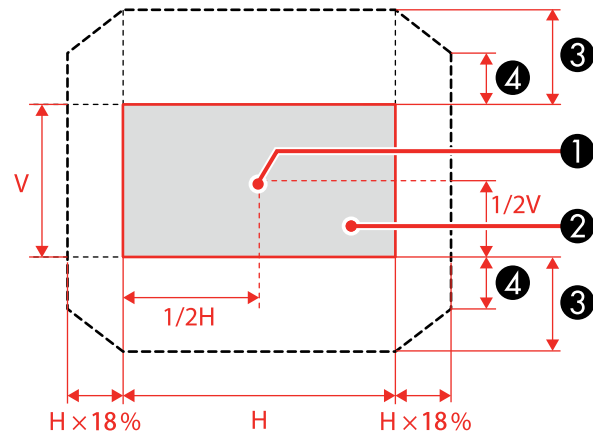

- 1 Center of lens
- 2 Projected image when lens shift is set to the home position
- 3 Maximum range: $V \times 60\%$; maximum range when performing screen matching: $V \times 40\%$ (ELPLU04)
- 4 Maximum range when the lens is shifted horizontally all the way: $V \times 31\%$

4. When you are finished, press the **Esc** button on the control panel or remote control.

Note: When adjusting the image height, position the image lower than where you want it to be and then move it up. This will help prevent the image from moving down after adjustment. The image is clearest when the lens is at the home position. To move the lens to the home position, press and hold the **Lens Shift** button on the remote control or the **Lens** button on the control panel for at least three seconds.

Parent topic: [Using Basic Projector Features](#)

Adjusting the Image Position Using Screen Position

You can adjust the image position if there are margins between the edge of the image and the projected screen frame.

Note: You cannot adjust the screen position if the Screen Type is set to **16:10**.

1. Turn on the projector and display an image.
2. Press the **Menu** button.
3. Select the **Extended** menu and press **Enter**.
4. Select **Display > Screen > Screen Position**.
5. Use the arrow buttons on the remote control or projector to adjust the position of the image.

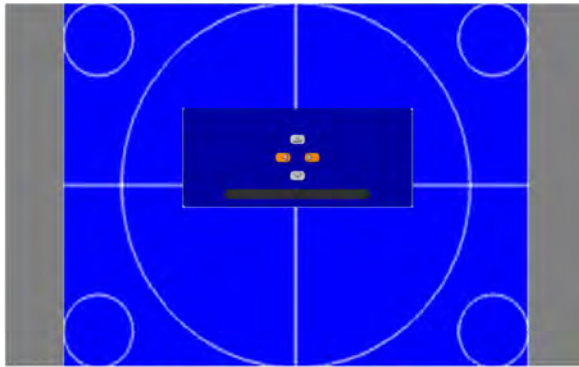

6. When you are finished, press the **Menu** button.

Parent topic: [Using Basic Projector Features](#)

Related tasks

[Setting the Screen Type](#)

Displaying a Test Pattern

You can display a test pattern to adjust the projected image without connecting a computer or video device.

Note: The test pattern's shape is determined by the Screen Type setting. Be sure to set the correct screen type before adjusting with the test pattern.

1. Turn on the projector.
2. Press the **Test Pattern** button on the remote control or the down arrow button on the control panel.

3. Press the left or right arrow buttons on the remote control or press **Enter** on the control panel to cycle through the available test patterns.
4. Adjust the image as necessary.
5. Press the **Esc** to clear the test pattern.

[Available Test Pattern Image Adjustments](#)

Parent topic: [Using Basic Projector Features](#)

Related tasks

[Setting the Screen Type](#)

Available Test Pattern Image Adjustments

You can adjust the following settings while the test pattern is displayed.

Menu	Settings
Image	Color Mode
	White Balance
	Advanced <ul style="list-style-type: none"> • Gamma¹ • RGBCMY
Signal	Auto Setup
Settings	Geometry Correction
	Brightness Settings
Extended	Display ²
	Color Calibration
	Multi-Projection ³

¹ Except for custom **Gamma** settings

² Except for the **Screen**, **Panel Alignment**, and **Color Uniformity** settings

³ Except for the **Black Level**, **Scale**, **Color Uniformity**, and **Color Adjustment** settings

Parent topic: [Displaying a Test Pattern](#)

Adjusting the Image Height

If you are projecting from a table or other flat surface, and the image is too high or low, you can adjust the image height using the projector's adjustable feet.

1. Turn on the projector and display an image.
2. To adjust the image height, rotate the front foot to extend or retract it.

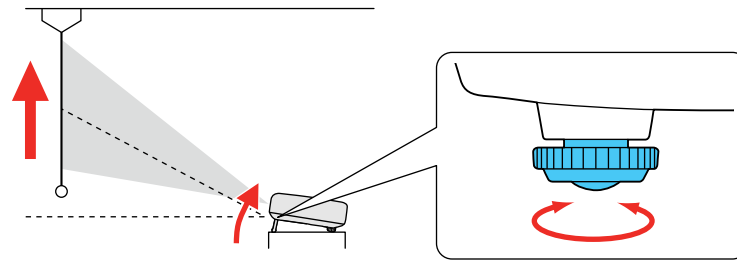

3. If the image is tilted, rotate the rear feet to adjust their height.

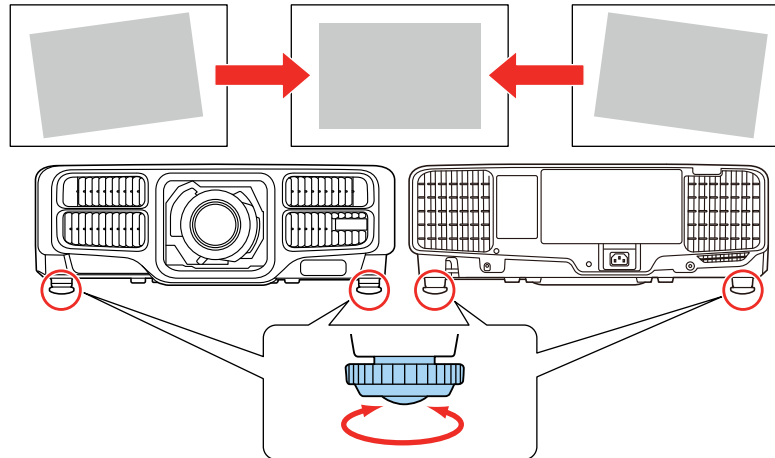

If the projected image is unevenly rectangular, you need to adjust the image shape.

Parent topic: [Using Basic Projector Features](#)

Related concepts

[Image Shape](#)

Image Shape

You can project an evenly rectangular image by placing the projector directly in front of the center of the screen and keeping it level. If you place the projector at an angle to the screen, or tilted up or down, or off to the side, you may need to correct the image shape for the best display quality.

[Correcting Image Shape with H/V Keystone](#)

[Correcting Image Shape with Quick Corner](#)

[Correcting Image Shape with Curved Surface](#)

[Correcting Image Shape with Corner Wall](#)

[Correcting Image Shape with Point Correction](#)

Parent topic: [Using Basic Projector Features](#)

Correcting Image Shape with H/V Keystone

You can use the projector's H/V Keystone setting to correct the shape of an image that is unevenly rectangular on the sides.

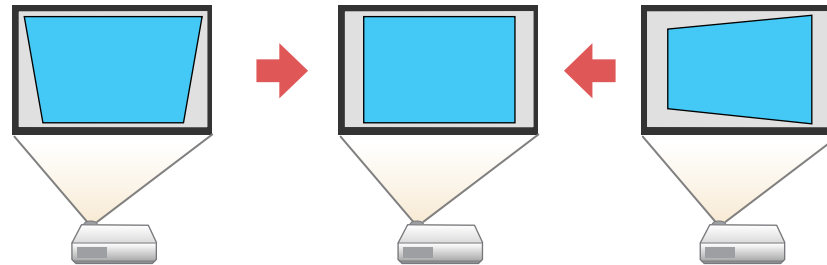

Note: You cannot combine H/V Keystone correction with other image adjustment methods.

1. Turn on the projector and display an image.

Note: You can display a pattern to aid in adjusting the projected image using the Settings menu.

Note: You can also display a pattern to aid in adjusting the projected image using the **Test Pattern** button on the remote control.

2. Press the **Menu** button.
3. Select the **Settings** menu and press **Enter**.

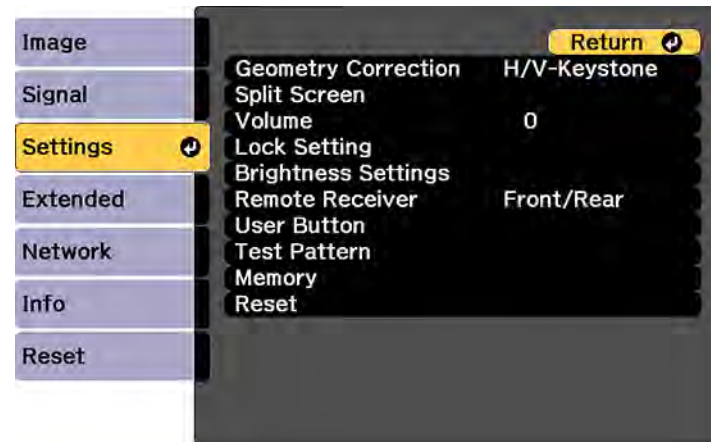

4. Select the **Geometry Correction** setting and press **Enter**.

Note: You can also access the geometric adjustment screen by pressing the **Geometry** button on the remote control or the up arrow button on the control panel.

5. Select the **H/V-Keystone** setting and press **Enter**. Then press **Enter** again.

You see the H/V-Keystone adjustment screen:



6. Use the arrow buttons on the projector or the remote control to select between vertical and horizontal keystone correction and to adjust the image shape as necessary.

V-Keystone

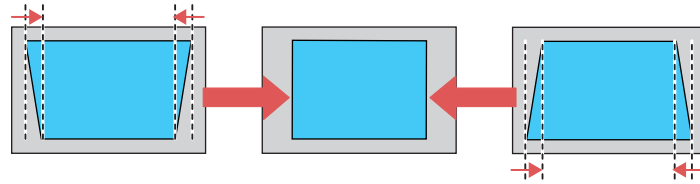

V-Balance

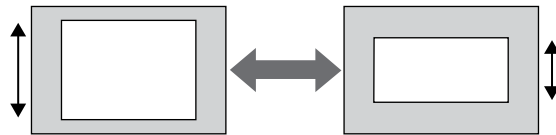

H-Keystone

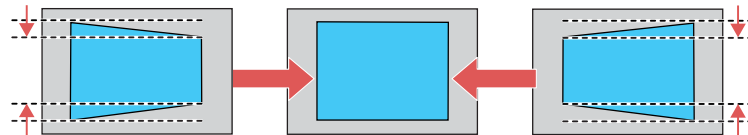

H-Balance

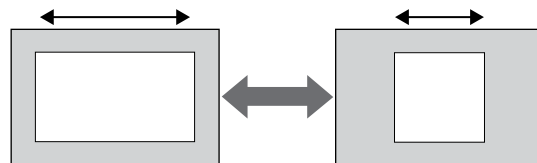

- When you are finished, press **Esc**.
After correction, your image is slightly smaller.

Parent topic: [Image Shape](#)

Related references

[Projector Feature Settings - Settings Menu](#)

Related tasks

[Displaying a Test Pattern](#)

Correcting Image Shape with Quick Corner

You can use the projector's Quick Corner setting to correct the shape and size of an image that is unevenly rectangular on all sides.

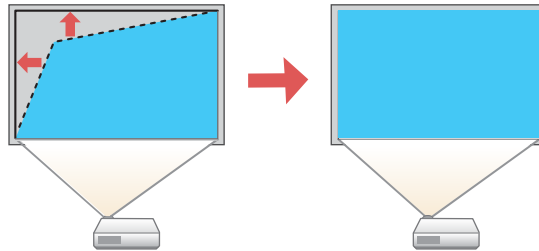

- Turn on the projector and display an image.

Note: You can display a pattern to aid in adjusting the projected image using the Settings menu.

Note: You can also display a pattern to aid in adjusting the projected image using the **Test Pattern** button on the remote control.

- Press the **Menu** button.

3. Select the **Settings** menu and press **Enter**.

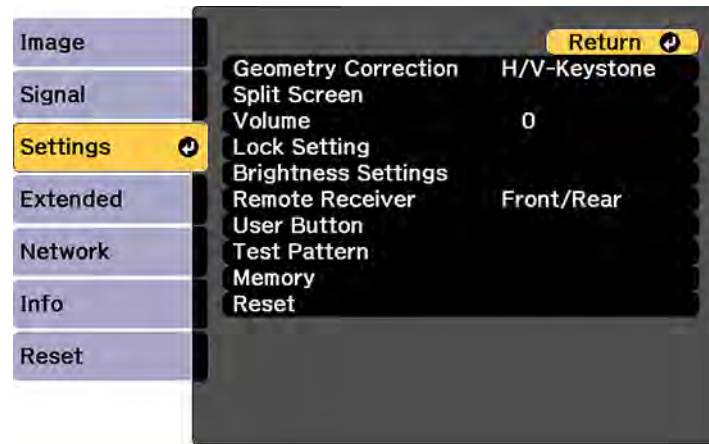

4. Select the **Geometry Correction** setting and press **Enter**.
5. Select the **Quick Corner** setting and press **Enter**. Then press **Enter** again.
You see the Quick Corner adjustment screen:

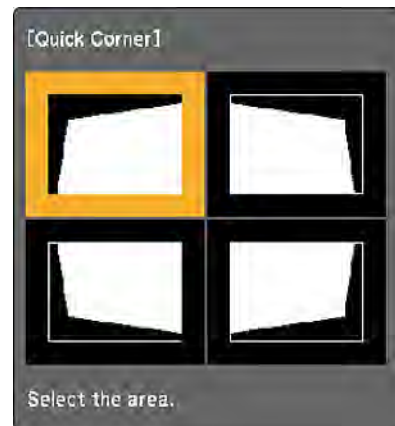

Note: To reset your adjustments, press and hold the **Esc** button for at least 2 seconds to display a reset screen. Then select **Yes**.

6. Use the arrow buttons on the projector or the remote control to select the corner of the image you want to adjust. Then press **Enter**.
7. Press the arrow buttons to adjust the image shape as necessary.
8. When you are finished, press **Esc**.

Parent topic: [Image Shape](#)

Related references

[Projector Feature Settings - Settings Menu](#)

Related tasks

[Displaying a Test Pattern](#)

Correcting Image Shape with Curved Surface

You can use the projector's Curved Surface setting to adjust the shape of an image projected on a curved surface.

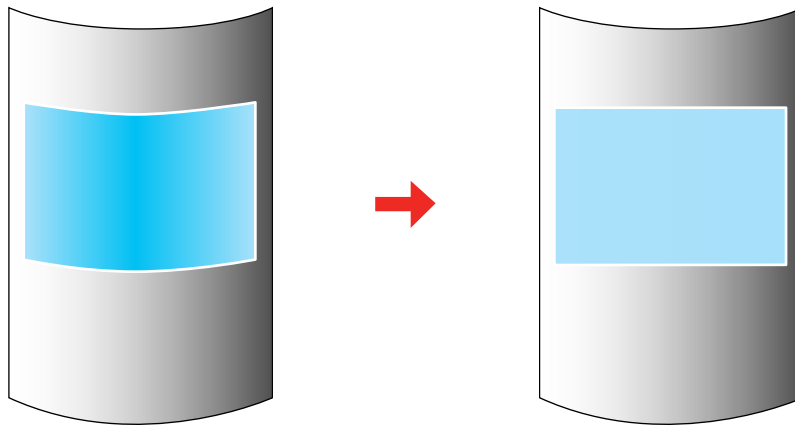

Note: For the best results, project from the front of the screen onto a surface with a uniform arc radius and with the lens in the home position. The image may not be evenly focused throughout even after performing the steps here. If you see a 4K Enhancement message, select **Yes** to disable the 4K Enhancement feature.

1. Turn on the projector and display an image.

Note: You can display a pattern to aid in adjusting the projected image using the Settings menu.

Note: You can also display a pattern to aid in adjusting the projected image using the **Test Pattern** button on the remote control.

2. Press the **Menu** button.
3. Select the **Settings** menu and press **Enter**.

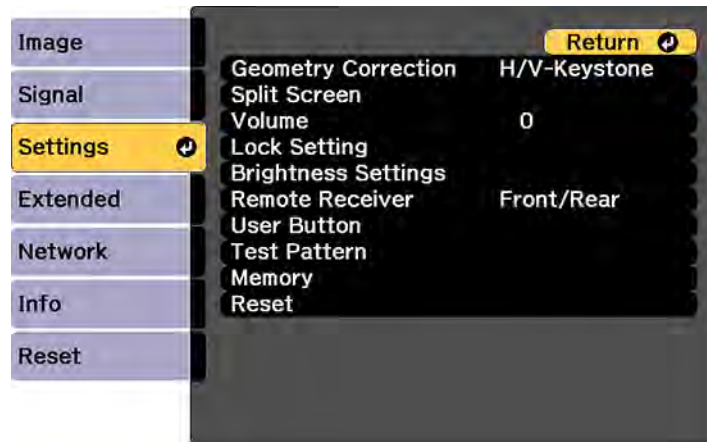

4. Select the **Geometry Correction** setting and press **Enter**.
5. Select the **Curved Surface** setting and press **Enter**.

Note: If you see a confirmation message, press **Enter**.

You see this screen:

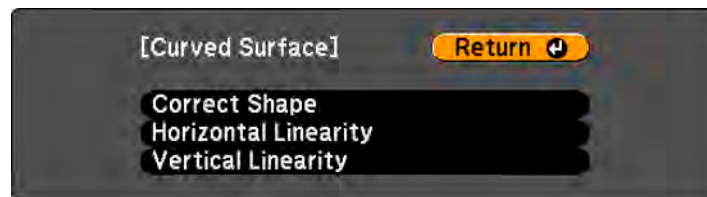

6. Select the **Correct Shape** setting and press **Enter**.

7. Use the arrow buttons on the projector or the remote control to select the area you want to adjust. Then press **Enter**.

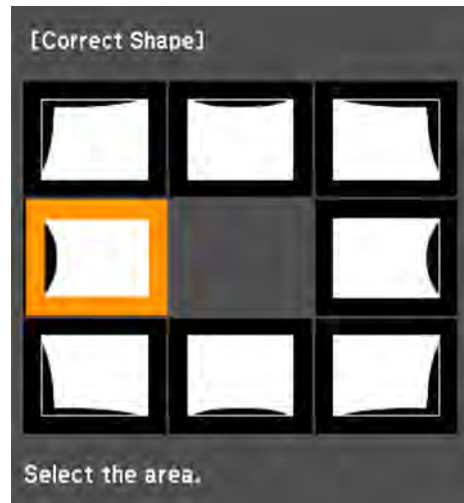

Note: To reset your adjustments, press and hold the **Esc** button for at least 2 seconds to display a reset screen. Then select **Yes**.

8. Use the arrow buttons on the projector to adjust the image shape.

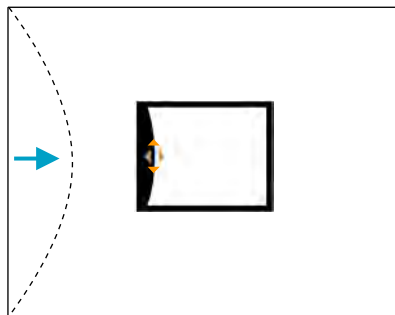

Note: If the adjustment triangle turns gray, you cannot adjust the shape any further in that direction.

9. Press the **Esc** button to return to the Curved Surface menu screen.
10. Repeat the previous three steps as necessary to adjust other image areas.
If the image expands or contracts, continue with the next step to adjust the linearity.
11. Select one of the following from the Curved Surface menu screen:
 - **Horizontal Linearity:** Adjusts horizontal expansion or contraction.
 - **Vertical Linearity:** Adjusts vertical expansion or contraction.
12. Select a displayed line to use as a baseline and press **Enter**.
The selected baseline flashes red and white.
13. Adjust the linearity by doing one of the following:
 - Press the left arrow button to contract the distance between the lines closest to the baseline.

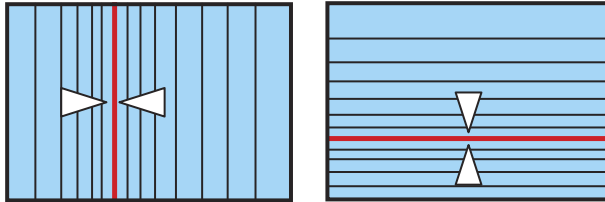

- Press the right arrow button to expand the distance between the lines closest to the baseline.

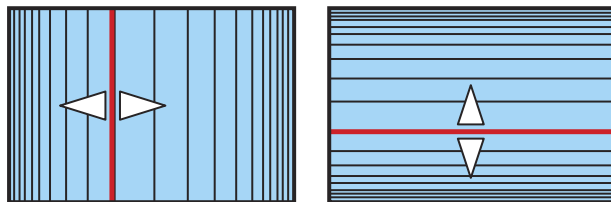

14. When you are finished, press the **Menu** button.

Note: If necessary, you can adjust the image tilt using the **Quick Corner** setting, then fine-tune your adjustments using the **Point Correction** setting.

Parent topic: [Image Shape](#)

Related references

[Projector Feature Settings - Settings Menu](#)

Related tasks

[Displaying a Test Pattern](#)

[Correcting Image Shape with Point Correction](#)

Correcting Image Shape with Corner Wall

You can use the projector's Corner Wall setting to adjust the shape of an image projected on a surface with right angles, such as a rectangular pillar or the corner of a room.

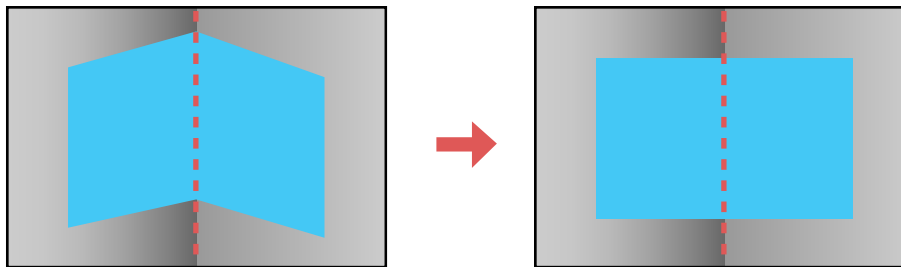

Note: For the best results, project from the front of the screen onto a right-angled surface and with the lens in the home position. The image may not be evenly focused throughout even after performing the steps here. If you see a 4K Enhancement message, select **Yes** to disable the 4K Enhancement feature. Corner Wall is not supported for the ELPLX01 lens.

1. Turn on the projector and display an image.

Note: You can display a pattern to aid in adjusting the projected image using the Settings menu.

Note: You can also display a pattern to aid in adjusting the projected image using the **Test Pattern** button on the remote control.

2. Press the **Menu** button.

3. Select the **Settings** menu and press **Enter**.

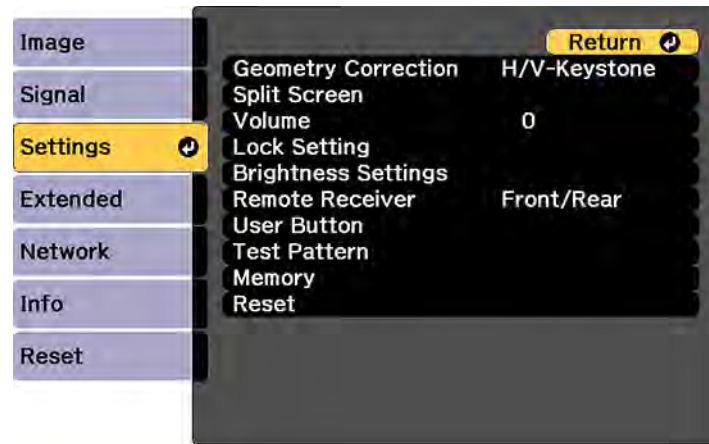

4. Select the **Geometry Correction** setting and press **Enter**.
5. Select the **Corner Wall** setting and press **Enter**.

Note: If you see a confirmation message, press **Enter**.

You see this screen:

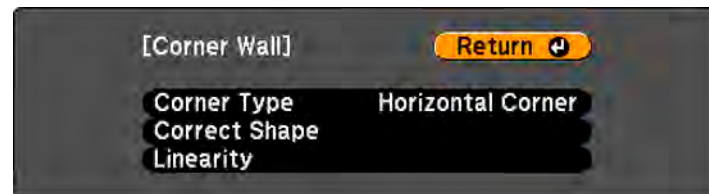

6. Select the **Corner Type** setting and press **Enter**.

7. Select one of the following:

- **Horizontal Corner** when the surfaces line up horizontally

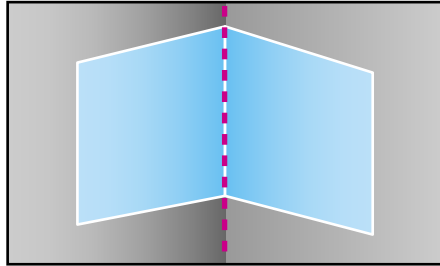

- **Vertical Corner** when the surfaces line up vertically

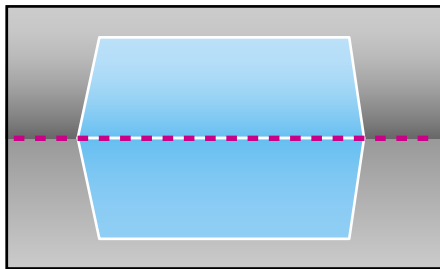

8. Press the **Esc** button to return to the Corner Wall menu screen.

9. Select the **Correct Shape** setting and press **Enter**.

10. Adjust the projector's position and use lens shift to center the image over the point where the two surfaces meet. (The rest of these steps show Horizontal Corner as the selected Corner Type but the steps are the same for Vertical Corner.)

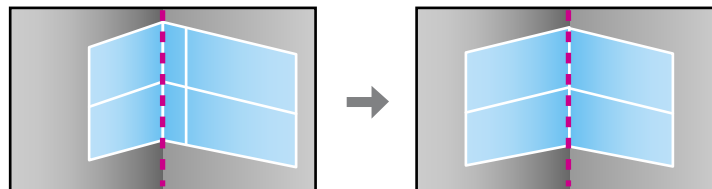

Note: You can press **Enter** to show or hide the image and grid to check the results.

11. Use the arrow buttons on the projector or the remote control to select the area you want to adjust. Then press **Enter**.

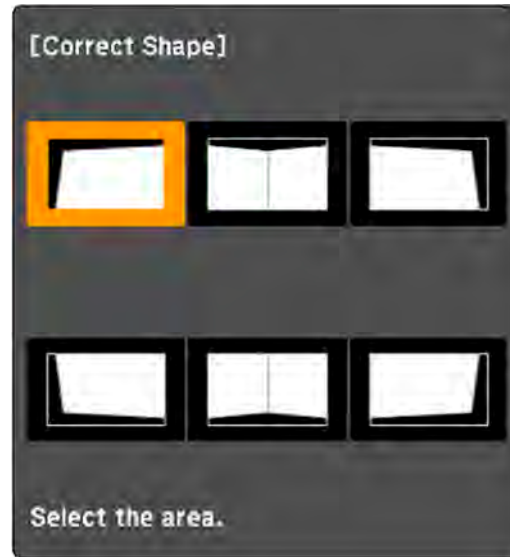

- For horizontal corners, adjust the top area using the lowest point (indicated by the blue arrow) as your reference. Adjust the lower area using the highest point (indicated by the pink arrow) as your reference.

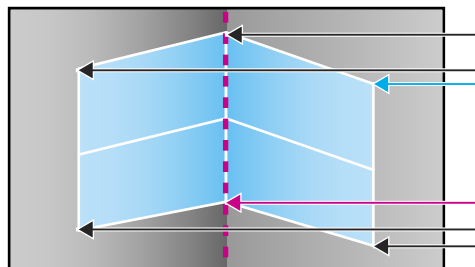

- For vertical corners, adjust the left and right areas using the points nearest the center of the image as your reference points.

Note: To reset your adjustments, press and hold the **Esc** button for at least 2 seconds to display a reset screen. Then select **Yes**.

12. Press and hold the arrow buttons on the projector or remote control to adjust the image shape.

13. Repeat the previous two steps as necessary to adjust other image areas.

If the image expands or contracts, continue with the next step to adjust the linearity.

14. Press the **Esc** button to return to the Corner Wall screen.

15. Select the **Linearity** setting and press **Enter**.

16. Adjust the linearity by doing the following as necessary:

- Press and hold the left arrow button to contract the distance between the lines closest to the left or top of the image.

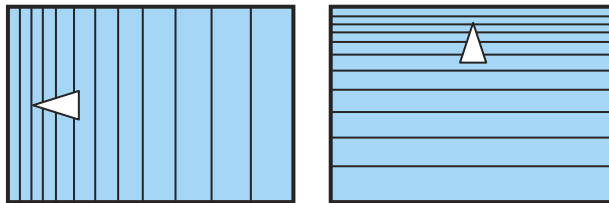

- Press and hold the right arrow button to contract the distance between the lines closest to the right or bottom of the image.

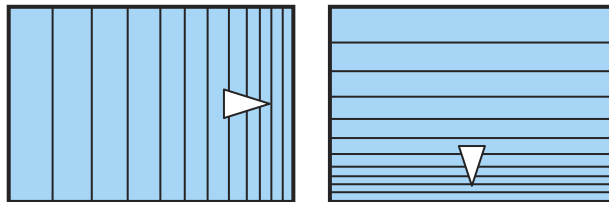

17. When you are finished, press the **Menu** button.

Note: If necessary, you can adjust the image tilt using the **Quick Corner** setting, then fine-tune your adjustments using the **Point Correction** setting.

Parent topic: [Image Shape](#)

Related references

[Projector Feature Settings - Settings Menu](#)

Related tasks

[Displaying a Test Pattern](#)

[Correcting Image Shape with Quick Corner](#)

[Correcting Image Shape with Point Correction](#)

Correcting Image Shape with Point Correction

You can use the projector's Point Correction feature to fine-tune the image shape using points on a grid. This is useful for adjusting overlapping areas in multiple projected images that do not line up correctly.



Note: You can move the points on the grid between 0.5 to 32 pixels in any direction. If you see a 4K Enhancement message, select **Yes** to disable the 4K Enhancement feature.

1. Turn on the projector and display an image.

Note: You can display a pattern to aid in adjusting the projected image using the Settings menu.

Note: You can also display a pattern to aid in adjusting the projected image using the **Test Pattern** button on the remote control.

2. Press the **Menu** button.

3. Select the **Settings** menu and press **Enter**.

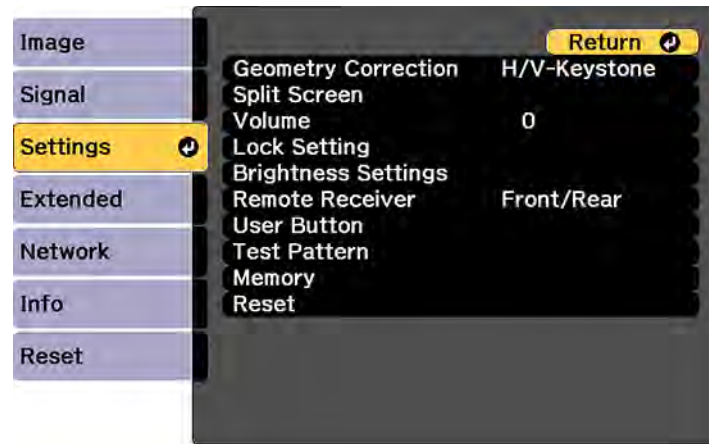

4. Select the **Geometry Correction** setting and press **Enter**.
5. Select the **Point Correction** setting and press **Enter**.

Note: If you see a confirmation message, press **Enter**.

You see this screen:

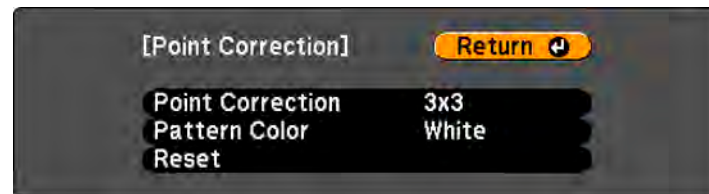

6. Select the **Point Correction** setting and press **Enter**.
7. Select the number of grid lines to display and press **Enter**.

Note: If you need to change the color of the grid lines, select the **Pattern Color** setting and select a suitable color.

8. Use the arrow buttons on the projector or remote control to move to the point on the grid that you want to adjust. Then press **Enter**.

The box changes from a single line to a double-lined square.

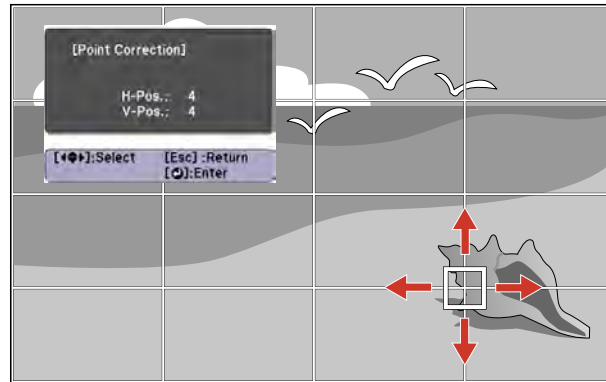

9. Use the arrow buttons to correct the image shape in all necessary directions.

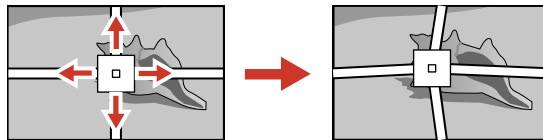

Note: You can press **Enter** to show or hide the image and grid to check the results.

10. Press **Esc** to return to the previous screen and select another point to correct, if necessary.
11. When you are finished, press the **Menu** button.

Note: If necessary, you can fine-tune your image adjustments using the **Corner Wall** setting.

Parent topic: [Image Shape](#)

Related references

[Projector Feature Settings - Settings Menu](#)

Related tasks

[Displaying a Test Pattern](#)

[Correcting Image Shape with Quick Corner](#)

Selecting an Image Source

If you connected multiple image sources to the projector, such as a computer and DVD player, you may want to switch from one image source to the other.

Note: If the **Auto Source Search** setting in the Extended menu is enabled, the projector automatically switches to another detected image source if the signal to the current image source is lost.

1. Make sure the connected image source you want to use is turned on.
2. For video image sources, insert a DVD or other video media and press its play button, if necessary.
3. Do one of the following:
 - Press the **Search** button on the remote control or the **Source Search** button on the projector until you see the image from the source you want.

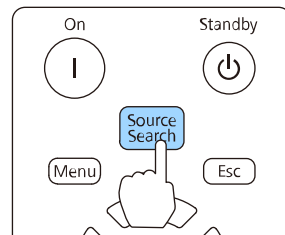
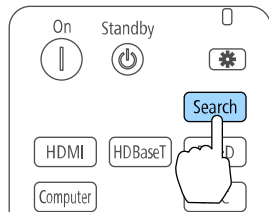

- Press the button for the source you want on the remote control.

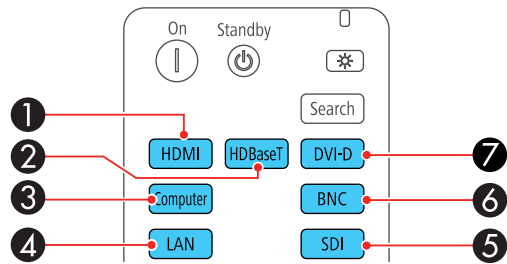

- 1 HDMI port source
- 2 HDBaseT port source
- 3 Computer port source
- 4 Network port source
- 5 SDI port source (Pro L1405U/L1500U/L1505U)
- 6 BNC port source
- 7 DVI-D port source

- Press the **Home** button on the remote control and select your image source.

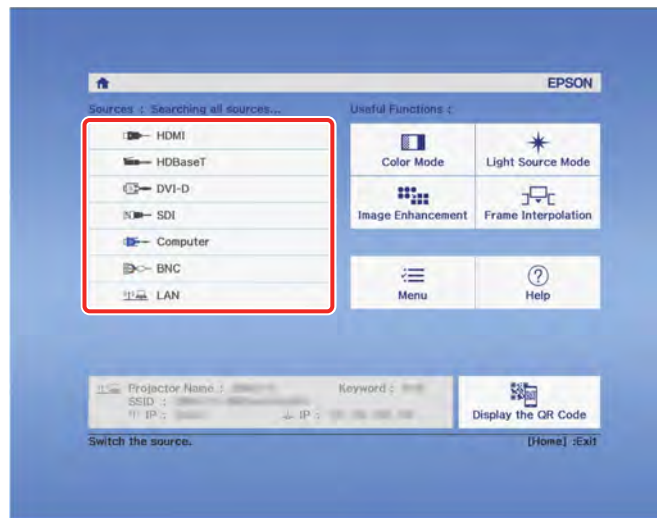

Parent topic: [Using Basic Projector Features](#)

Related references

[Projector Setup Settings - Extended Menu](#)

Remote Control Operation

The remote control lets you control the projector from almost anywhere in the room, up to 98.4 feet (30 m) away. You can point it at the front or rear of the projector.

Make sure that you aim the remote control at the projector's receivers within the angles listed here.

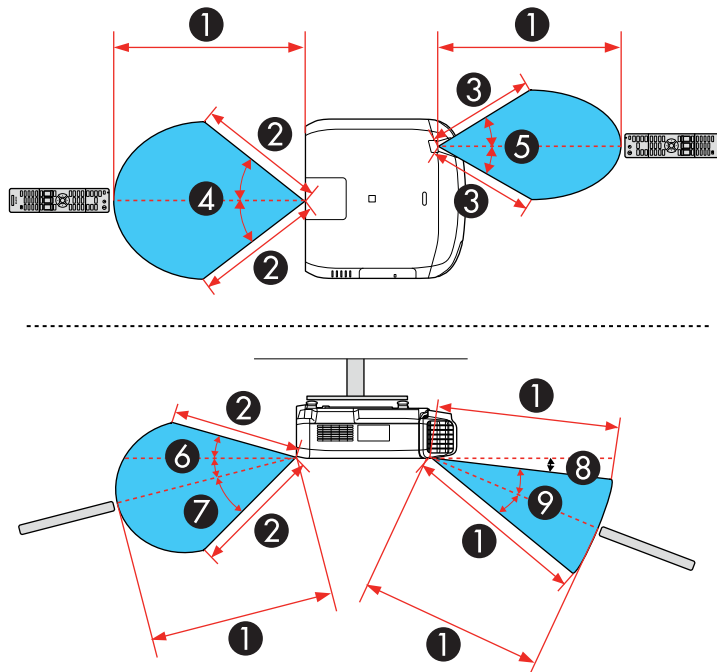

- 1 98.4 feet (30 m)
- 2 82.0 feet (25 m)
- 3 65.6 feet (20 m)
- 4 $\pm 60^\circ$
- 5 $\pm 30^\circ$
- 6 $\pm 15^\circ$
- 7 30°
- 7 10°
- 8 $\pm 20^\circ$

Note: Avoid using the remote control in conditions with bright fluorescent lights or in direct sunlight, or the projector may not respond to commands. If you will not use the remote control for a long time, remove the batteries.

Parent topic: [Using Basic Projector Features](#)

Related tasks

[Replacing the Remote Control Batteries](#)

Projection Modes

Depending on how you positioned the projector, you may need to change the projection mode so your images project correctly.

- **Front** (default setting) lets you project from a table in front of the screen.
- **Front/Ceiling** flips the image over top-to-bottom to project upside-down from a ceiling or wall mount.
- **Rear** flips the image horizontally to project from behind a translucent screen.
- **Rear/Ceiling** flips the image over top-to-bottom and horizontally to project from the ceiling and behind a translucent screen.

Note: To view 3D images, you must project onto the front of a silver screen designed for passive 3D images.

[Changing the Projection Mode Using the Remote Control](#)

[Changing the Projection Mode Using the Menus](#)

Parent topic: [Using Basic Projector Features](#)

Changing the Projection Mode Using the Remote Control

You can change the projection mode to flip the image over top-to-bottom.

1. Turn on the projector and display an image.
2. Hold down the **A/V Mute** button on the remote control for five seconds.

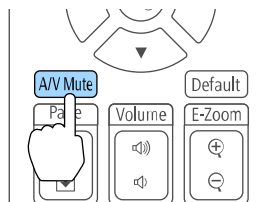

The image disappears briefly and reappears flipped top-to-bottom.

3. To change projection back to the original mode, hold down the **A/V Mute** button for five seconds again.

Parent topic: [Projection Modes](#)

Changing the Projection Mode Using the Menus

You can change the projection mode to flip the image over top-to-bottom and/or left-to-right using the projector menus.

1. Turn on the projector and display an image.
2. Press the **Menu** button.
3. Select the **Extended** menu and press **Enter**.

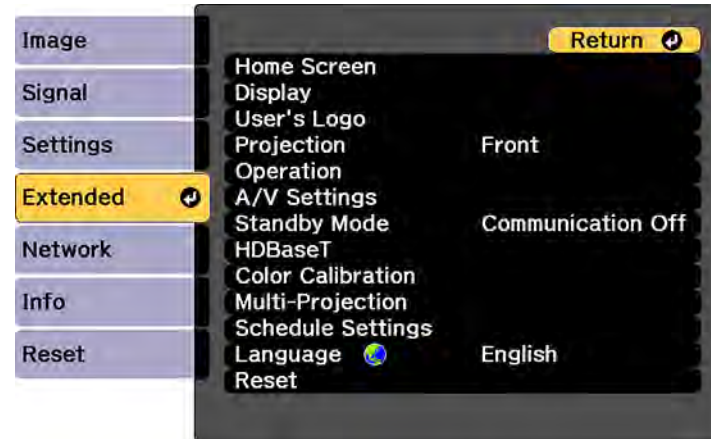

4. Select the **Projection** setting and press **Enter**.
5. Select a projection mode and press **Enter**.
6. Press **Menu** or **Esc** to exit the menus.

Parent topic: [Projection Modes](#)

Image Aspect Ratio

The projector can display images in different width-to-height ratios called aspect ratios. Normally the input signal from your video source determines the image's aspect ratio. However, for certain images you can change the aspect ratio to fit your screen by pressing a button on the remote control.

If you always want to use a particular aspect ratio for a certain video input source, you can select it using the projector's menus.

[Changing the Image Aspect Ratio](#)

[Available Image Aspect Ratios](#)

Parent topic: [Using Basic Projector Features](#)

Related references

[Image Quality Settings - Image Menu](#)

Changing the Image Aspect Ratio

You can change the aspect ratio of the displayed image to resize it.

Note: Set the **Screen Type** setting in the projector's Extended menu before changing the aspect ratio.

1. Turn on the projector and switch to the image source you want to use.
2. Press the **Aspect** button on the remote control.

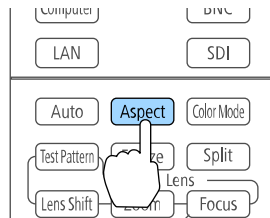

The shape and size of the displayed image changes, and the name of the aspect ratio appears briefly on the screen.

3. To cycle through the available aspect ratios for your input signal, press the **Aspect** button repeatedly.

Note: If you are projecting from a computer and parts of the image are cut-off, set the **Resolution** setting to **Wide** or **Normal** in the Signal menu.

Parent topic: [Image Aspect Ratio](#)

Related references

[Input Signal Settings - Signal Menu](#)

Related tasks

[Setting the Screen Type](#)

Available Image Aspect Ratios

You can select the following image aspect ratios, depending on the selected Screen Type setting and the input signal from your image source.

Note: Black bands and cropped or stretched images may project in certain aspect ratios, depending on the aspect ratio and resolution of your input signal.

Screen Type setting	Available aspect ratios
4:3	Auto, Normal, 4:3, 6:9, Native*
16:9	Auto, Normal, Full, H-Zoom, V-Zoom, Native
16:10	Auto, Normal, 16:9, Full, H-Zoom, V-Zoom, Native

*Available only when projecting computer images, or from sources connected to the **HDMI** or **HDBaseT** port

Aspect ratio setting	Description
Auto	Automatically sets the aspect ratio according to the input signal.
Normal	Displays images in the same aspect ratio of the input signal.
4:3	Displays images at a 4:3 aspect ratio.
16:9	Displays images at a 16:9 aspect ratio.
Full	Displays images using the full size of the projection area, but does not maintain the aspect ratio.
H-Zoom V-Zoom	Displays images using the full width (H-Zoom) or full height (V-Zoom) of the projection area and maintains the aspect ratio of the image. Areas that exceed the edges of the projected screen are not projected.

Aspect ratio setting	Description
Native	Displays images as is (aspect ratio and resolution are maintained). Areas that exceed the edges of the projected screen are not projected.

Parent topic: [Image Aspect Ratio](#)

Related tasks

[Setting the Screen Type](#)

Color Mode

The projector offers different Color Modes to provide optimum brightness, contrast, and color for a variety of viewing environments and image types. You can select a mode designed to match your image and environment, or experiment with the available modes.

If you always want to use a particular color mode for a certain video input source, you can select it using the projector menus.

[Changing the Color Mode](#)

[Available Color Modes](#)

Parent topic: [Using Basic Projector Features](#)

Related references

[Image Quality Settings - Image Menu](#)

Changing the Color Mode

You can change the projector's Color Mode using the remote control to optimize the image for your viewing environment.

1. Turn on the projector and switch to the image source you want to use.
2. If you are projecting from a DVD player or other video source, insert a disc or other video media and press the play button, if necessary.

3. Press the **Color Mode** button on the remote control to change the Color Mode.

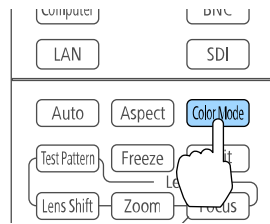

The image appearance changes and the name of the Color Mode appears briefly on the screen.

4. To cycle through all the available Color Modes for your input signal, press the **Color Mode** button repeatedly.

Parent topic: [Color Mode](#)

Available Color Modes

You can set the projector to use these Color Modes, depending on the input source you are using:

Color Mode	Description
Dynamic	Best for projecting in a bright room
Presentation	Best for color presentations in a bright room
Cinema	Best for movies projected in a dark room
sRGB	Best for standard sRGB computer displays
DICOM SIM*	Best for projecting X-ray photographs and other medical images
Multi-Projection	Best for projecting from multiple projectors (reduces the color tone difference between images)

* Available only when inputting RGB signals

Note: The **DICOM SIM** Color Mode is for reference purposes only and should not be used to make medical diagnoses.

Parent topic: [Color Mode](#)

Adjusting the Brightness

You can adjust the brightness of your projector's light source.

1. Turn on the projector and switch to the image source you want to use.
2. Press the **Menu** button.
3. Select the **Settings** menu and press **Enter**.

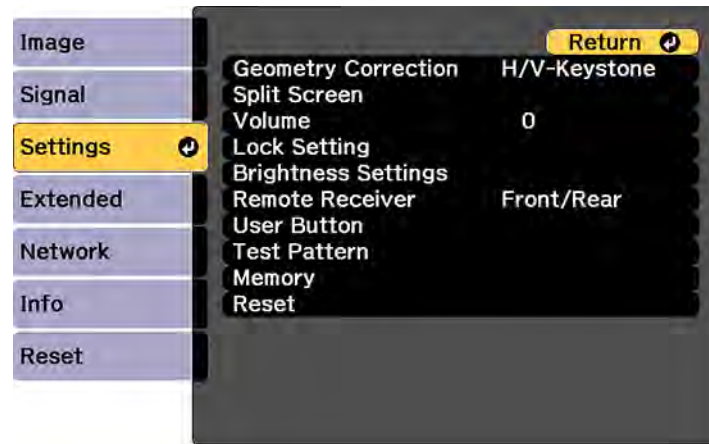

4. Select the **Brightness Settings** setting and press **Enter**.

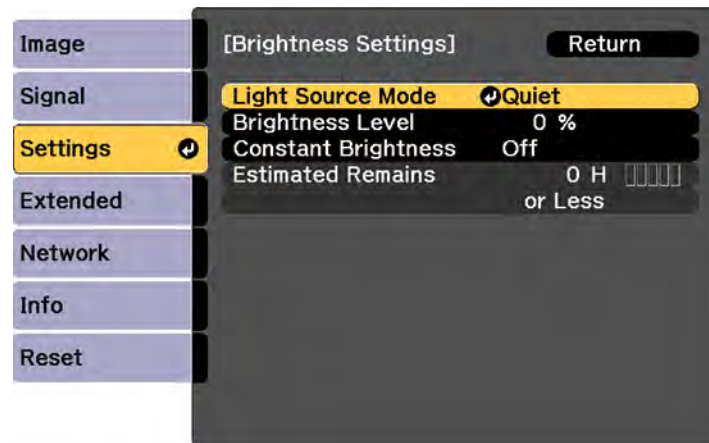

5. Select the **Light Source Mode** setting and press **Enter**.
6. Select one of the following options:
 - **Normal**: Sets brightness to maximum level (ideal for conference rooms, auditoriums, and lecture halls)
 - **Quiet**: Sets brightness to 70% and reduces fan noise (ideal for libraries, theaters, museums, and art galleries)
 - **Extended**: Sets brightness to 70% and extends the life expectancy of the light source (ideal for darker environments with ambient light, such as museums and art galleries, where a reduced maintenance cycle is desired)
 - **Custom**: Allows you to select a custom brightness level between 30 to 70%
7. If you selected **Custom**, select **Brightness Level** from the Brightness Settings screen and use the left and right arrow buttons to select the brightness. To maintain consistent brightness, turn on the **Constant Brightness** setting.

Note: If you turn on **Constant Brightness**, you cannot change the **Light Source Mode** and **Brightness Level** settings. If you turn off **Constant Brightness**, the **Brightness Level** setting changes according to the status of the light source.

8. Press **Menu** or **Esc** to exit the menus.

Note: If you use the projector continuously for more than 24 hours, or regularly turn it off by shutting off the power outlet, schedule periodic **Light Source Calibration** events from the Extended menu. Otherwise, the **Constant Brightness** setting may not work properly.

[Constant Brightness Usage Hours](#)

Parent topic: [Using Basic Projector Features](#)

Related references

[Projector Setup Settings - Extended Menu](#)

Related tasks

[Saving a Scheduled Event](#)

Constant Brightness Usage Hours

If you turn on the **Constant Brightness** setting, the number of hours the projector can maintain constant brightness is displayed as the **Estimated Remains** setting.

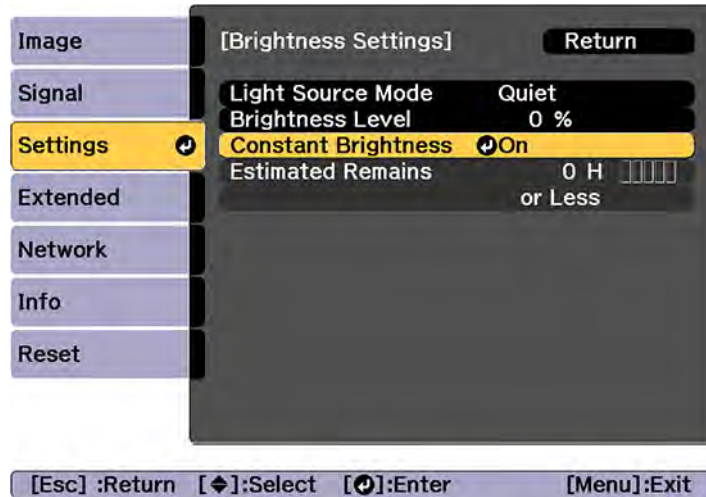

Display level	Estimated remaining hours
	10000 or more hours
█	8000 to 9999 hours
██	6000 to 7999 hours
███	4000 to 5999 hours
████	2000 to 3999 hours
█████	0 to 1999 hours

Light source life span

The estimated life span of the light source varies depending on the **Brightness Level** setting and whether the **Constant Brightness** setting is on or off.

Constant Brightness off

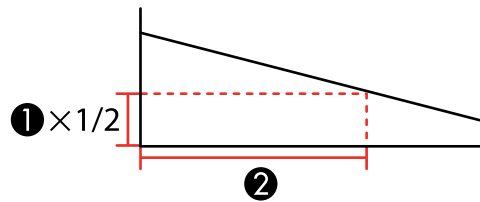

- 1 Brightness level
- 2 Time before the brightness of the light source is reduced by half (approximate)

Brightness Level setting	Hours
100%	20000 hours
90%	21000 hours
80%	24000 hours
70%	30000 hours
60%	37000 hours
50%	47000 hours
40%	61000 hours
30%	71000 hours

Constant Brightness on

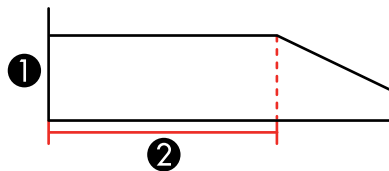

- 1 Brightness level
- 2 Time the projector can maintain constant brightness (approximate)

Brightness Level setting	Hours
90%	6000 hours
80%	10000 hours
70%	19000 hours
60%	29000 hours
50%	41000 hours
40%	56000 hours
30%	78000 hours

Note: The light source usage hours vary depending upon environmental conditions and usage. The hours listed here are an approximate and are not guaranteed. After 20000 hours of use, you may need to replace parts in the projector. If **Constant Brightness** is turned on, and you have exceeded the usage hours listed here, you may not be able to select a high **Brightness Level** setting.

Parent topic: [Adjusting the Brightness](#)

Turning On Automatic Luminance Adjustment

In the **Dynamic** and **Cinema** color modes, you can turn on the **Dynamic Contrast** setting to automatically optimize the image luminance. This improves the image contrast based on the brightness of the content you project.

1. Turn on the projector and switch to the image source you want to use.
2. Press the **Menu** button.

3. Select the **Image** menu and press **Enter**.

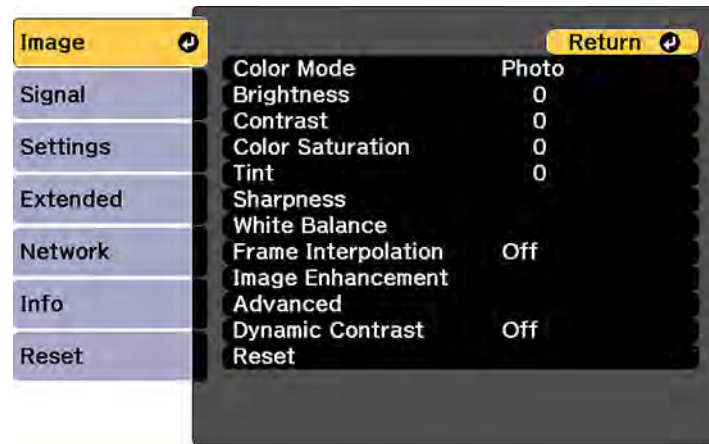

4. Select the **Dynamic Contrast** setting, choose one of the following options, and press **Enter**:
 - **High Speed** to adjust brightness as soon as the scene changes.
 - **Normal** to adjust brightness at the standard speed.
5. Press **Menu** or **Esc** to exit the menus.

Parent topic: [Using Basic Projector Features](#)

Controlling the Volume with the Volume Buttons

You can use the **Volume** buttons on the remote control to adjust the volume as you project a presentation with audio. The volume buttons control the projector's internal speaker system (Pro L1100U/L11200U/L1300U) or any external speakers you connected to the projector.

You must adjust the volume separately for each connected input source.

1. Turn on the projector and start a presentation that includes audio.

2. To lower or raise the volume, press the **Volume** buttons on the remote control.

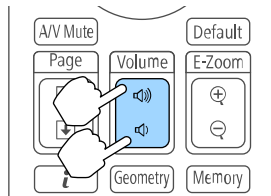

A volume gauge appears on the screen.

3. To set the volume to a specific level for an input source, use the projector menus.

Parent topic: [Using Basic Projector Features](#)

Related references

[Projector Feature Settings - Settings Menu](#)

Related tasks

[Connecting to External Speakers](#)

Setting the Date and Time

You can set the date and time for the projector.

Note: If the **Schedule Protection** setting in the Password Protection screen is enabled, you cannot change the date and time settings.

1. Press the **Menu** button.
2. Select the **Extended** menu and press **Enter**.
3. Select the **Operation** setting and press **Enter**.
4. Select the **Date & Time** setting and press **Enter**.

You see a screen like this:



5. Select your date and time settings. Then select **Set** and press **Enter** to confirm your changes.
6. When you are finished, press the **Menu** button to exit.

[Date and Time Settings](#)

Parent topic: [Using Basic Projector Features](#)

Related concepts

[Password Security Types](#)

Date and Time Settings

Settings	Options	Description
Date & Time	Date Time Time Difference (UTC)	Adjusts the projector's date and time settings Date and Time: sets the date and time Time Difference (UTC): sets the time difference from Coordinated Universal Time

Settings	Options	Description
Daylight Saving Time	Daylight Saving Time DST Start DST End DST Adjustment (min)	Adjusts the daylight saving time settings Daylight Saving Time: enables or disables daylight saving time DST Start and DST End: sets the date and time to start or end daylight saving time DST Adjustment (min): sets the difference between standard and daylight saving time
Internet Time	Internet Time Internet Time Server	Automatically adjusts the time through an Internet connection Internet Time: turn on this setting to update the date and time automatically through an Internet time server Internet Time Server: sets the IP address for the Internet time server

Parent topic: [Setting the Date and Time](#)

Adjusting Projector Features

Follow the instructions in these sections to use your projector's feature adjustments.

[Shutting Off the Picture and Sound Temporarily](#)

[Stopping Video Action Temporarily](#)

[Zooming Into and Out of Images](#)

[Projector Security Features](#)

[Projecting Two Images Simultaneously](#)

[Using Advanced Image Adjustment Features](#)

[Using Multiple Projectors](#)

[Enabling Protocol Emulation](#)

[Viewing 3D Images](#)

[Saving Settings to Memory and Using Saved Settings](#)

[Saving a Scheduled Event](#)

[Copying Menu Settings Between Projectors](#)

Shutting Off the Picture and Sound Temporarily

You can temporarily turn off the projected picture and sound if you want to redirect your audience's attention during a presentation. Any sound or video action continues to run, however, so you cannot resume projection at the point that you stopped it.

If you want to display an image such as a company logo or picture when the presentation is stopped, you can set up this feature using the projector's menus.

Note: If the picture and sound are off for more than 2 hours, the power automatically turns off. You can disable the **A/V Mute Timer** setting in the Extended Menu to turn off this feature.

1. Press the **A/V Mute** button on the remote control to temporarily stop projection and mute any sound.

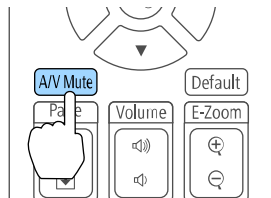

2. To turn the picture and sound back on, press **A/V Mute** again.

Note:

- To fade the image in and out when you use A/V Mute, turn on the **Fade-out** and/or **Fade-in** settings in the Extended menu.
- If you selected **A/V Mute** for the **A/V Mute Release** setting in the Extended menu, you can still control the projector while A/V Mute is enabled.

Parent topic: [Adjusting Projector Features](#)

Related references

[Projector Setup Settings - Extended Menu](#)

Stopping Video Action Temporarily

You can temporarily stop the action in a video or computer presentation and keep the current image on the screen. Any sound or video action continues to run, however, so you cannot resume projection at the point that you stopped it.

1. Press the **Freeze** button on the remote control to stop the video action.

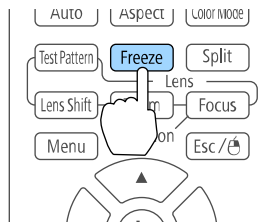

2. To restart the video action in progress, press **Freeze** again.

Parent topic: [Adjusting Projector Features](#)

Zooming Into and Out of Images

You can draw attention to parts of a presentation by zooming into a portion of the image and enlarging it on the screen.

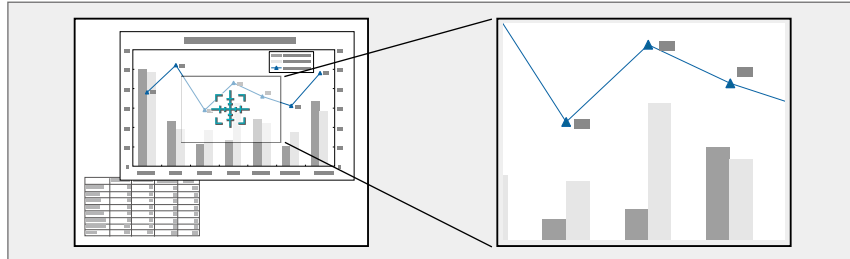

Note: This feature is unavailable if the **Scale** setting in the Signal menu is enabled. If you see a 4K Enhancement message, select **Yes** to disable the 4K Enhancement feature.

1. Press the **E-Zoom +** button on the remote control.

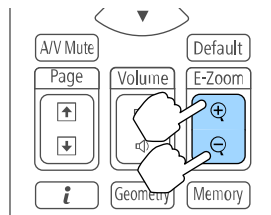

You see a crosshair on the screen indicating the center of the zoom area.

2. Use the following buttons on the remote control to adjust the zoomed image:
 - Use the arrow buttons to position the crosshair in the image area you want to zoom into.
 - Press the **E-Zoom +** button repeatedly to zoom into the image area, enlarging it as necessary. Press and hold the **E-Zoom +** button to zoom in more quickly.
 - To pan around the zoomed image area, use the arrow buttons.
 - To zoom out of the image, press the **E-Zoom –** button as necessary.
 - To return to the original image size, press **Esc**.

Parent topic: [Adjusting Projector Features](#)

Related references

[Input Signal Settings - Signal Menu](#)

Projector Security Features

You can secure your projector to deter theft or prevent unintended use by setting up the following security features:

- Password security to prevent the projector from being turned on, and prevent changes to the startup screen and other settings.
- Button lock security to block operation of the projector using the buttons on the control panel or remote control.
- Security cabling to physically cable the projector in place.

[Password Security Types](#)

[Locking the Projector's Buttons](#)

[Locking the Remote Control Buttons](#)

[Installing a Security Cable](#)

Parent topic: [Adjusting Projector Features](#)

Password Security Types

You can set up these types of password security using one shared password:

- **Power On Protection** password prevents anyone from using the projector without first entering a password.
- **User's Logo Protection** password prevents anyone from changing the custom screen the projector can display when it turns on or when you use the A/V Mute feature. The presence of the custom screen discourages theft by identifying the projector's owner.
- **Network Protection** password prevents anyone from changing the network settings in the projector menus.
- **Schedule Protection** password prevents anyone from changing the projector's time or schedule settings.

[Setting a Password](#)

[Selecting Password Security Types](#)

[Entering a Password to Use the Projector](#)

[Saving a User's Logo Image to Display](#)

Parent topic: [Projector Security Features](#)

Setting a Password

To use password security, you must set a password.

1. Hold down the **Freeze** button on the remote control for about five seconds or until you see this menu.



2. Press the down arrow to select **Password** and press **Enter**.
You see the prompt "Change the password?".
3. Select **Yes** and press **Enter**.
4. Press and hold down the **Num** button on the remote control and use the numeric buttons to set a four-digit password.

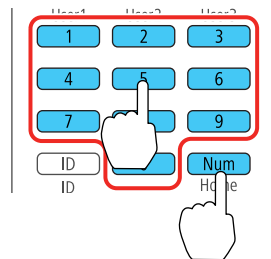

The password displays as **** as you enter it. Then you see the confirmation prompt.

5. Enter the password again.
You see the message "Password accepted."
6. Press **Esc** to return to the menu.

7. Make a note of the password and keep it in a safe place in case you forget it.

Parent topic: [Password Security Types](#)

Selecting Password Security Types

After setting a password, you see this menu, allowing you to select the password security types you want to use.

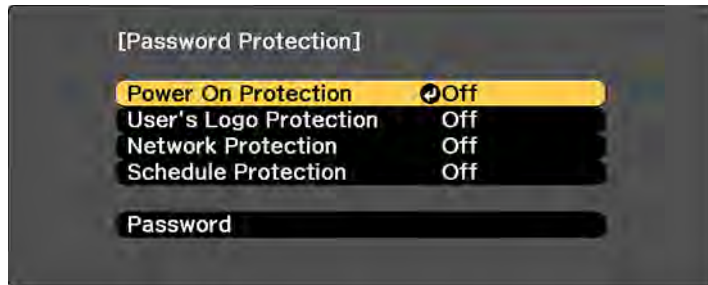

If you do not see this menu, hold down the **Freeze** button on the remote control for about five seconds or until the menu appears.

1. To prevent unauthorized use of the projector, select **Power On Protection**, press **Enter**, select **On**, press **Enter** again, and press **Esc**.
2. To prevent changes to the User's Logo screen or related display settings, select **User's Logo Protection**, press **Enter**, select **On**, press **Enter** again, and press **Esc**.
3. To prevent changes to network settings, select **Network Protection**, press **Enter**, select **On**, press **Enter** again, and press **Esc**.
4. To prevent changes to the projector's time or schedule settings, select **Schedule Protection**, press **Enter**, select **On**, press **Enter** again, and press **Esc**.

Note: Be sure to keep the remote control in a safe place; if you lose it, you will not be able to enter the password required to use the projector.

Parent topic: [Password Security Types](#)

Entering a Password to Use the Projector

If a password is set up and a **Power On Protection** password is enabled, you see a prompt to enter a password whenever you turn on the projector.

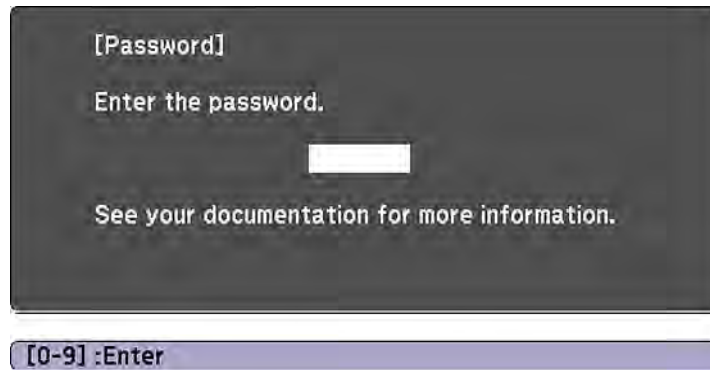

You must enter the correct password to use the projector.

1. Press and hold down the **Num** button on the remote control while you enter the password using the numeric buttons.

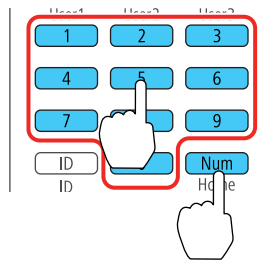

Note: The default password is **0000**.

The password screen closes.

2. If the password is incorrect, the following may happen:
 - You see a "wrong password" message and a prompt to try again. Enter the correct password to proceed.

- If you enter an incorrect password several times in succession, the projector displays a request code and a message to contact Epson Support. Do not attempt to enter the password again. When you contact Epson Support, provide the displayed request code and proof of ownership for assistance in unlocking the projector.

Parent topic: [Password Security Types](#)

Saving a User's Logo Image to Display

You can transfer an image to the projector and then display it whenever the projector turns on. You can also display the image when the projector is not receiving an input signal or when you temporarily stop projection (using the A/V Mute feature). This transferred image is called the User's Logo screen.

The image you select as the User's Logo can be a photo, graphic, or company logo, which is useful in identifying the projector's owner to help deter theft. You can prevent changes to the User's Logo by setting up password protection for it.

1. Display the image you want to project as the User's Logo.
2. Press the **Menu** button, select the **Extended** menu, and press **Enter**.

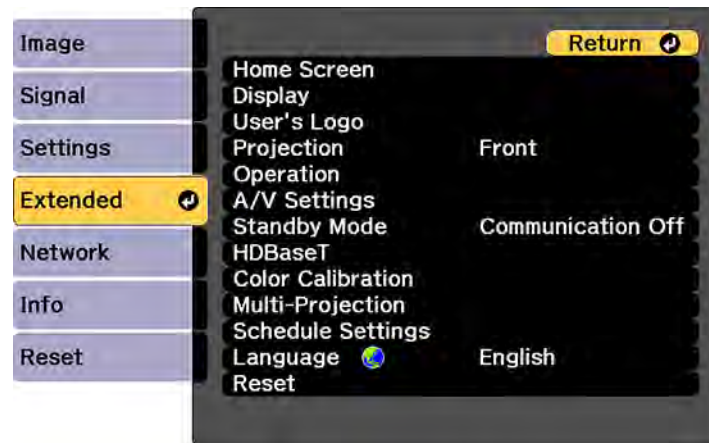

3. Select the **User's Logo** setting and press **Enter**.
You see a prompt asking if you want to use the displayed image as a user's logo.
4. Select **Yes** and press **Enter**.
You see a selection box overlaying your image.

5. Use the arrow buttons on the remote control or control panel to surround the image area you want to use as the User's Logo and press **Enter**.

You see a prompt asking if you want to select this image area.

6. Select **Yes** and press **Enter**. (If you want to change the selected area, select **No**, press **Enter**, and repeat the last step.)

You see the User's Logo zoom factor menu.

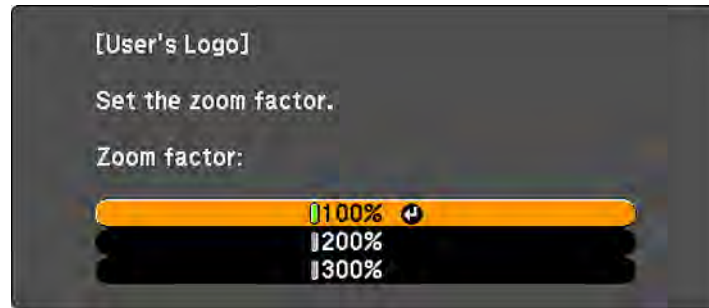

7. Select a zoom percentage and press **Enter**.

You see a prompt asking if you want to save the image as the User's Logo.

8. Select **Yes** and press **Enter**.

You see a completion message.

9. Press **Esc** to exit the message screen.

10. Select the **Extended** menu and press **Enter**.

11. Select **Display** and press **Enter**.

12. Select when you want to display the User's Logo screen:

- To display it whenever there is no input signal, select **Display Background** and set it to **Logo**.
- To display it whenever you turn the projector on, select **Startup Screen** and set it to **On**.

To prevent anyone from changing the User's Logo settings without first entering a password, set a password and enable User's Logo security.

Parent topic: [Password Security Types](#)

Locking the Projector's Buttons

You can lock the buttons on the projector's control panel to prevent anyone from using the projector. You can lock all the buttons or all the buttons except the power button.

1. Press the **Menu** button.
2. Select the **Settings** menu and press **Enter**.

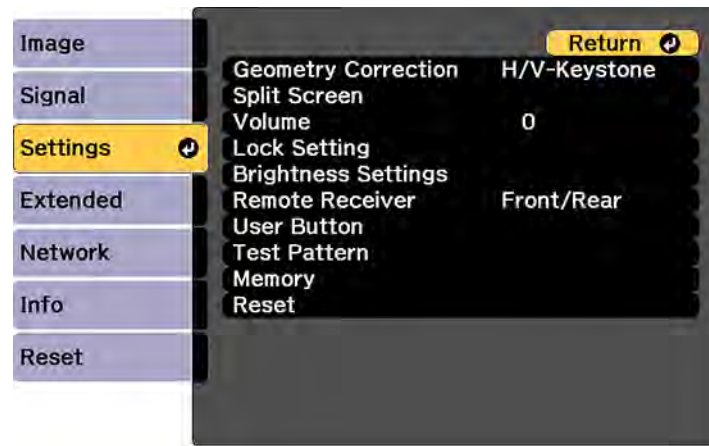

3. Select **Lock Setting** and press **Enter**.
4. Select the **Control Panel Lock** setting and press **Enter**.

Note: You can also press the left arrow button on the control panel to display the Control Panel Lock screen.

5. Select one of these lock types and press **Enter**:
 - To lock all of the projector's buttons, select **Full Lock**.
 - To lock all buttons except the power button, select **Partial Lock**.

You see a confirmation prompt.

6. Select **Yes** and press **Enter**.

[Unlocking the Projector's Buttons](#)

Parent topic: [Projector Security Features](#)

Related references

[Projector Parts - Control Panel](#)

Unlocking the Projector's Buttons

If the projector's buttons have been locked, hold the **Enter** button on the projector's control panel for seven seconds to unlock them.

Parent topic: [Locking the Projector's Buttons](#)

Locking the Remote Control Buttons

You can lock some of the buttons on the remote control.

- To lock the remote control buttons related to lens operation, turn on the **Lens Lock** setting in the Settings menu.
- To lock the remote control buttons shown here, press and hold the **Home** button for approximately 5 seconds. (To unlock the buttons, press and hold the **Home** button again for approximately 5 seconds.)

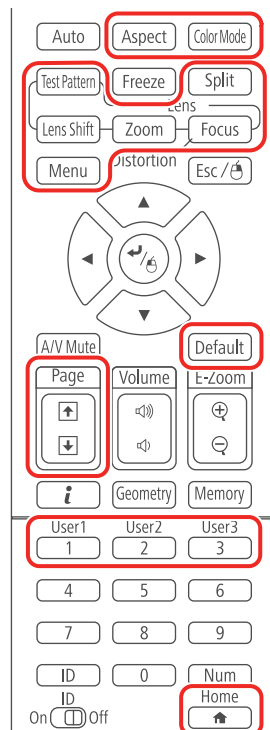

Note: If you lock the remote control buttons, you can still reset the **Remote Receiver** setting in the Settings menu to the default settings.

Parent topic: [Projector Security Features](#)

Related references

[Projector Feature Settings - Settings Menu](#)

Installing a Security Cable

You can install two types of security cables on the projector to deter theft.

- Use the security slot on the projector to attach a Kensington lock. See your local computer or electronics dealer for purchase information.
- Use the security cable attachment point on the projector to attach a wire cable and secure it to a room fixture or heavy furniture.

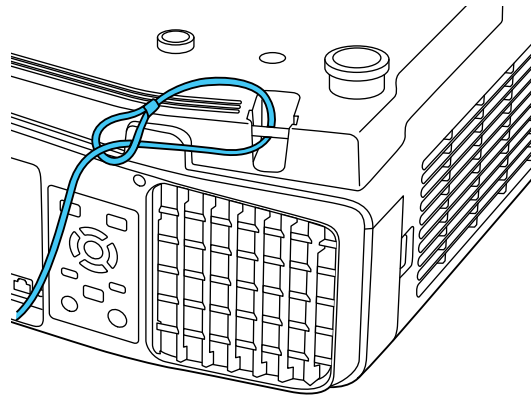

Note: Do not pass drop-prevention cables through the security cable attachment point when mounting the projector on a wall or ceiling.

Parent topic: [Projector Security Features](#)

Related references

[Projector Parts - Rear](#)

Projecting Two Images Simultaneously

You can use the split screen feature to simultaneously project two images from different image sources next to each other. You can control the split screen feature using the remote control or the projector menus.

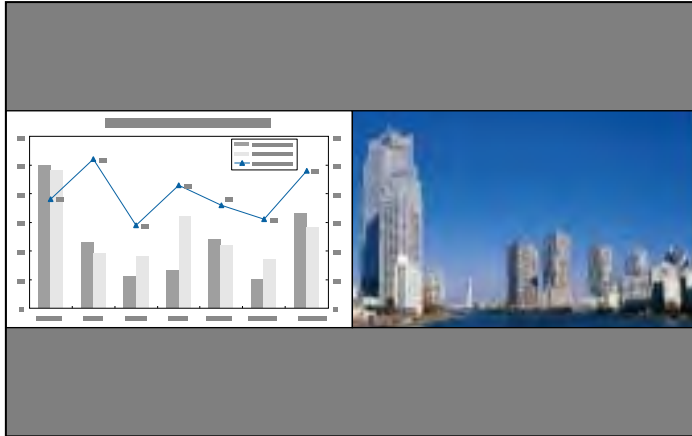

Note: While you use the split screen feature, other projector features may not be available and some settings may be automatically applied to both images.

1. Press the **Split** button on the remote control.

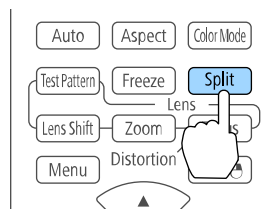

The currently selected input source moves to the left side of the screen.

2. Press the **Menu** button.

You see this screen:

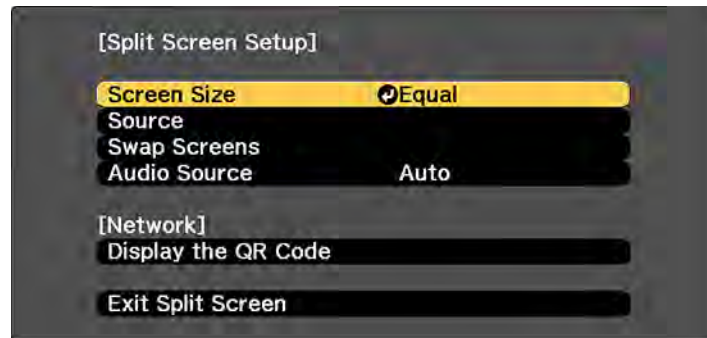

3. To select an input source for the other image, select the **Source** setting, press **Enter**, select the input source, select **Execute**, and press **Enter**. (You can also change image sources, if necessary.)
4. To switch the images, select the **Swap Screens** setting and press **Enter**.
5. To change the image sizes, select the **Screen Size** setting, press **Enter**, select a sizing option, press **Enter**, and press **Menu** to exit.

Note: Depending on the video input signals, the images may not appear at the same size even if you choose the **Equal** setting.

6. To choose the audio you want to hear, select the **Audio Source** setting, press **Enter**, select an audio option, press **Enter**, and press **Menu** to exit.

Note: Select **Auto** to hear audio from the largest screen or the left screen.

7. To exit the split screen feature, press the **Split** or **Esc** button.

[Input Sources for Split Screen Projection](#)

Parent topic: [Adjusting Projector Features](#)

Input Sources for Split Screen Projection

You can choose from the input source combinations listed here for split screen projection.

Note: Input signals exceeding WUXGA are not supported. If you see a 4K Enhancement message, select **Yes** to disable the 4K Enhancement feature.

Left Screen	Right Screen						
	HDMI	HDBaseT	DVI-D	SDI*	Computer	BNC	LAN
HDMI	—	✓	✓	✓	✓	✓✓	✓
HDBaseT	✓	—	✓	✓	✓	✓	✓
DVI-D	✓	✓	—	✓	✓	✓	✓
SDI*	✓	✓	✓	—	—	—	—
Computer	✓	✓	✓	—	—	—	—
BNC	✓	✓	✓	—	—	—	—
LAN	✓	✓	✓	—	—	—	—

* Pro L1405U/L1500U/L1505U only

Parent topic: [Projecting Two Images Simultaneously](#)

Using Advanced Image Adjustment Features

Follow the instructions in these section to use your projector's advanced image adjustments.

[Using Frame Interpolation](#)

[Using 4K Enhancement](#)

[Creating Image Presets](#)

[Using MPEG Noise Reduction](#)

[Adjusting Scaled Resolution Images \(Super-resolution\)](#)

[Adjusting Detail Enhancement](#)

[Adjusting the Color Convergence \(Panel Alignment\)](#)

[Adjusting the Color Tone \(Color Uniformity\)](#)

Parent topic: [Adjusting Projector Features](#)

Using Frame Interpolation

You can use the projector's Frame Interpolation feature to smooth fast-moving video by comparing consecutive image frames and inserting an intermediate image frame between them.

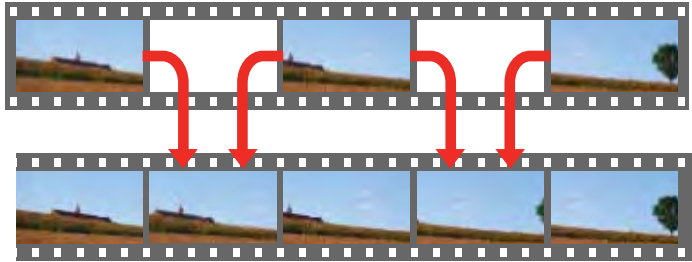

You cannot use this feature if any of the following conditions are true:

- You are using the E-Zoom feature
- The image signal exceeds WUXGA
- You turned on the **4K Enhancement**, **Edge Blending**, or **Scale** settings
- You selected **Fast 1** or **Fast 2** for the **Image Processing** setting

1. Press the **Menu** button.

You see a screen like this:

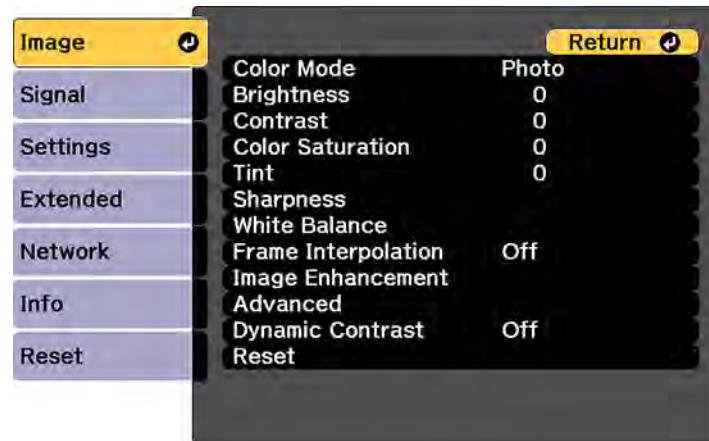

2. Select the **Frame Interpolation** setting and press **Enter**.

You see a screen like this:

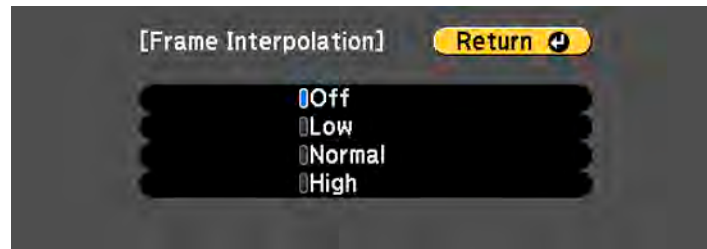

3. Select the level of interpolation and press **Enter**.
4. When you are finished, press the **Menu** button.

Note: If your resulting images contain noise, turn off the **Frame Interpolation** setting.

Parent topic: [Using Advanced Image Adjustment Features](#)

Related references

[Image Quality Settings - Image Menu](#)

[Projector Feature Settings - Settings Menu](#)

[Projector Setup Settings - Extended Menu](#)

Related tasks

[Zooming Into and Out of Images](#)

Using 4K Enhancement

Using the projector's 4K Enhancement Technology, you can receive 4K (3840 × 2160) signals and project ultra high-definition images. This technology shifts each pixel diagonally by 0.5 pixels to double the image resolution.

1. Press the **Menu** button.

You see a screen like this:

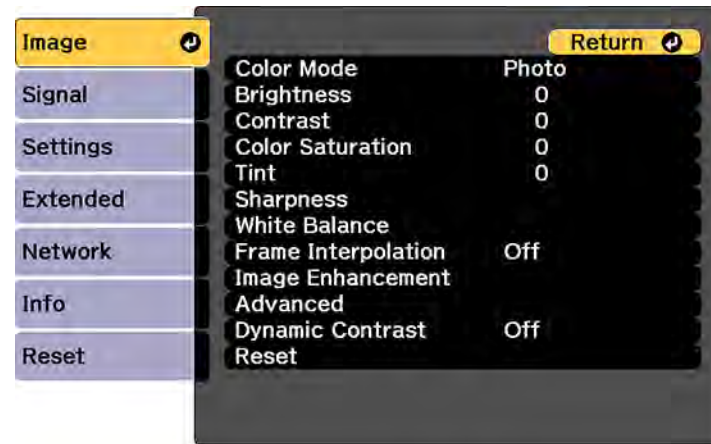

2. Select the **Image Enhancement** setting and press **Enter**.
3. Select the **4K Enhancement** setting and press **Enter**.

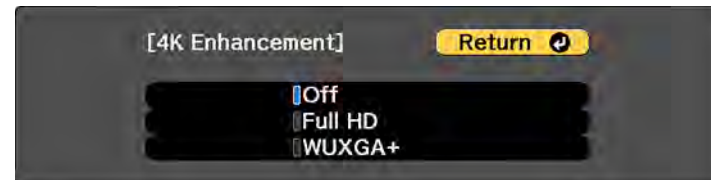

4. Select one of the following options and press **Enter**:
 - **Off** to disable 4K enhancement when projecting from computers or multiple projectors
 - **Full HD** to enhance a signal with a resolution of 1080i/1080p/WUXGA or higher
 - **WUXGA+** to enhance a signal with a resolution exceeding WUXGA; when projecting a high-resolution movie, select **WUXGA+** along with an appropriate **Image Preset Mode** setting

Note: If you select **Full HD** or **WUXGA+**, the following adjustment settings are canceled: **Edge Blending**, **Scale**, **Curved Surface**, **Point Correction**, and **Corner Wall**.

5. Press **Menu** or **Esc** to exit the menus.

Parent topic: [Using Advanced Image Adjustment Features](#)

Related references

[Projector Feature Settings - Settings Menu](#)

[Projector Setup Settings - Extended Menu](#)

Creating Image Presets

You can quickly optimize your projected image by selecting image adjustment settings and saving them as a preset you can reuse later.

You can save the following settings in a preset:

- Noise Reduction
- MPEG Noise Reduction
- Super-resolution
- Detail Enhancement

1. Press the **Menu** button.

You see a screen like this:

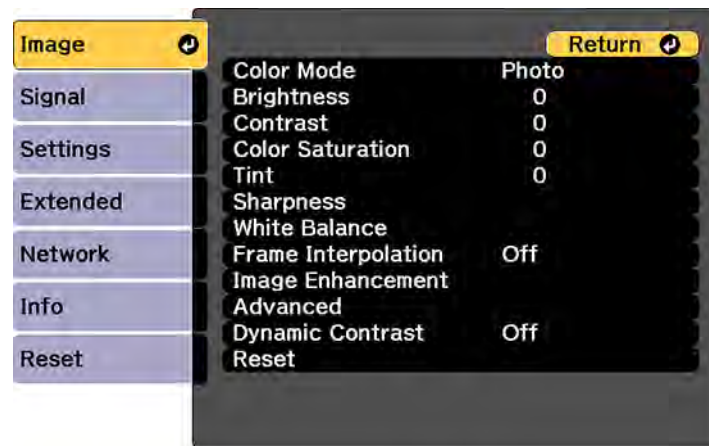

2. Select the **Image Enhancement** setting and press **Enter**.

3. Select the **Image Preset Mode** setting and press **Enter**.

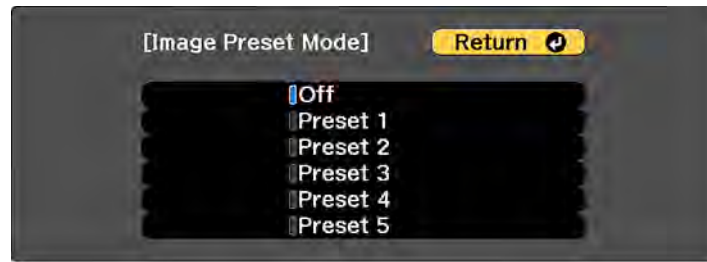

4. Select one of the presets.
5. Fine-tune each setting individually and press **Enter**.

Note: If you select a previously used preset, your new adjustments overwrite the old ones.

6. Press **Menu** or **Esc** to exit the menus.

Parent topic: [Using Advanced Image Adjustment Features](#)

Related references

[Image Quality Settings - Image Menu](#)

Using MPEG Noise Reduction

If you are projecting MPEG movies, you can reduce dots and block noise using the **MPEG Noise Reduction** setting.

Note: If you enable the **4K Enhancement** setting, or the resolution of your input signal exceeds WUXGA, this setting is disabled.

1. Press the **Menu** button.

You see a screen like this:

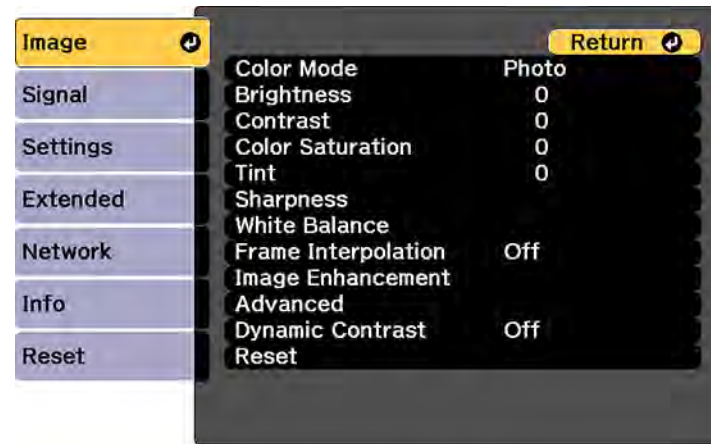

2. Select the **Image Enhancement** setting and press **Enter**.
3. Select the **MPEG Noise Reduction** setting and press **Enter**.

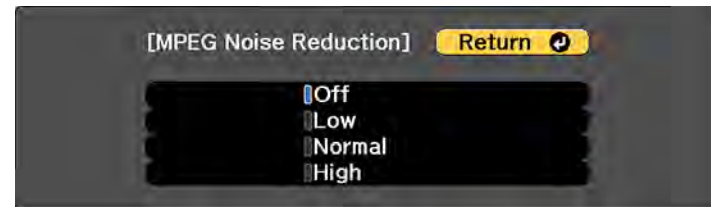

4. Select the level of noise reduction and press **Enter**.
5. Press **Menu** or **Esc** to exit the menus.

Parent topic: [Using Advanced Image Adjustment Features](#)

Related tasks

[Using 4K Enhancement](#)

Adjusting Scaled Resolution Images (Super-resolution)

You can sharpen blurry, low-resolution images that had their resolution scaled up for projection using the **Super-resolution** setting.

1. Turn on the projector and switch to the image source you want to use.
2. Press the **Menu** button.

You see a screen like this:



3. Select the **Image Enhancement** setting and press **Enter**.
4. Select the **Super-resolution** setting and press **Enter**.



5. Adjust each of the following options as necessary:
 - **Fine Line Adjust** to enhance fine details such as hair and fabric patterns
 - **Soft Focus Detail** to enhance the outline, background, and main parts of an image

Note: Higher values increase the intensity of the effect.

6. Press **Menu** or **Esc** to exit the menus.

Parent topic: [Using Advanced Image Adjustment Features](#)

Adjusting Detail Enhancement

You can enhance the contrast in detailed areas of an image to create a more textured look.

1. Turn on the projector and switch to the image source you want to use.
2. Press the **Menu** button.

You see a screen like this:

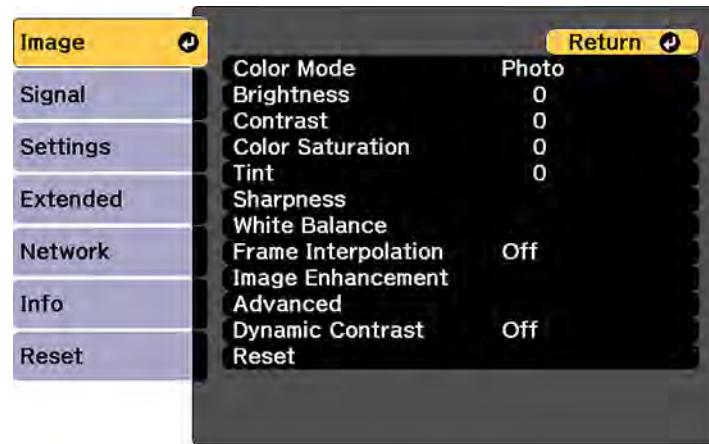

3. Select the **Image Enhancement** setting and press **Enter**.
4. Select the **Detail Enhancement** setting and press **Enter**.



5. Adjust each of the following options as necessary:
 - **Strength** to enhance the image contrast
 - **Range** to increase the enhanced area of the image

Note: Higher values increase the intensity of the effect.

6. Press **Menu** or **Esc** to exit the menus.

Parent topic: [Using Advanced Image Adjustment Features](#)

Adjusting the Color Convergence (Panel Alignment)

You can use the Panel Alignment feature to manually adjust the color convergence (the alignment of the red, green and blue colors) in the projected image.

Note: Allow your projector to warm up for at least 10 to 15 minutes and make sure the image is in focus before you use the Panel Alignment feature. The projected image size should be at least 60 inches (152 cm) diagonally and the projection surface should not be colored or textured; otherwise the adjustment grids are difficult to align.

1. Press the **Menu** button.
2. Select the **Extended** menu and press **Enter**.

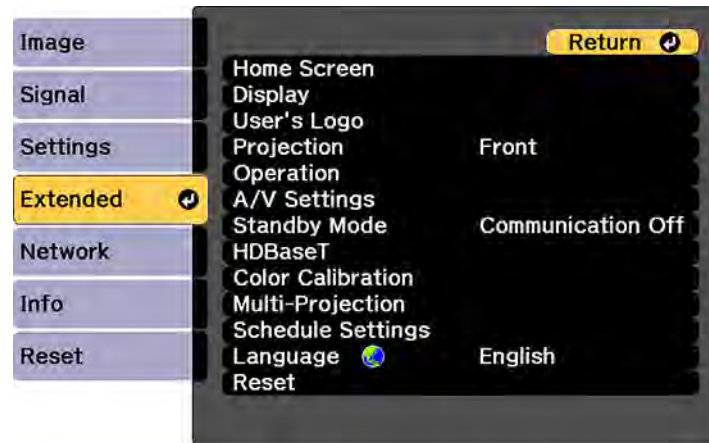

3. Select the **Display** setting and press **Enter**.
4. Select the **Panel Alignment** setting and press **Enter**.
5. Press **Enter** and select **On**.
6. Press **Esc**.
7. Select the **Select Color** setting and choose one of the following:
 - **R** to adjust the red color convergence

- **B** to adjust the blue color convergence

Note: You can adjust only the red or blue color convergence; you cannot adjust the standard green color panel.

8. Select the **Pattern Color** setting and press **Enter**.
9. Select the pattern you want to use and press **Esc**.
10. Select **Start Adjustments** and press **Enter** twice.

You see this screen:

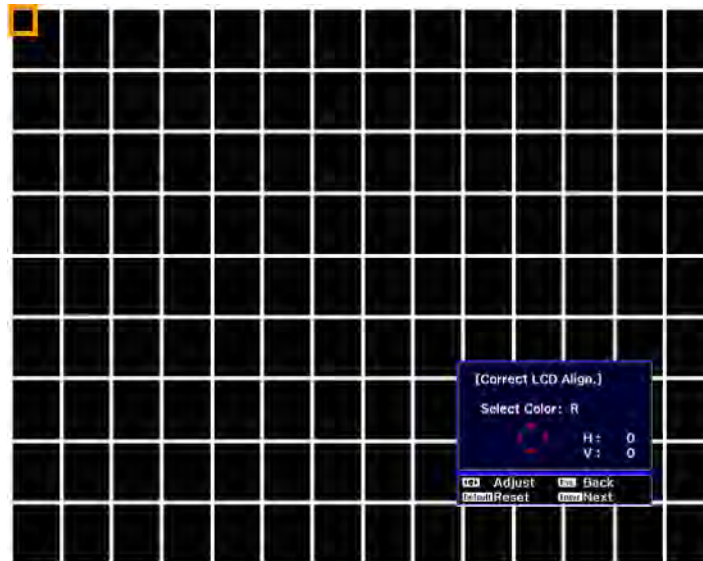

11. Use the arrow buttons on the remote control to adjust the color alignment in the corner of the screen highlighted by the orange box.
12. Press the **Enter** button to move to the next corner of the screen.
13. When you are finished adjusting each corner of the screen, press **Enter**.

You see this screen:

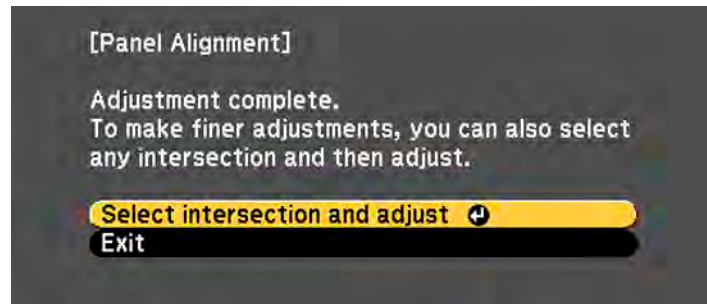

14. Do one of the following:

- If your projector's panel alignment is now correct, select **Exit** and press **Enter** to return to the Panel Alignment menu.
- If your projector needs additional panel alignment, select **Select intersection and adjust** and press **Enter**. Use the arrow keys on the remote control to highlight the corner of any box on the screen that is misaligned and press **Enter** to adjust the color convergence. Repeat this step as necessary.

Parent topic: [Using Advanced Image Adjustment Features](#)

Adjusting the Color Tone (Color Uniformity)

You can use the Color Uniformity feature to manually adjust the color tone balance in the projected image.

1. Press the **Menu** button.

2. Select the **Extended** menu and press **Enter**.

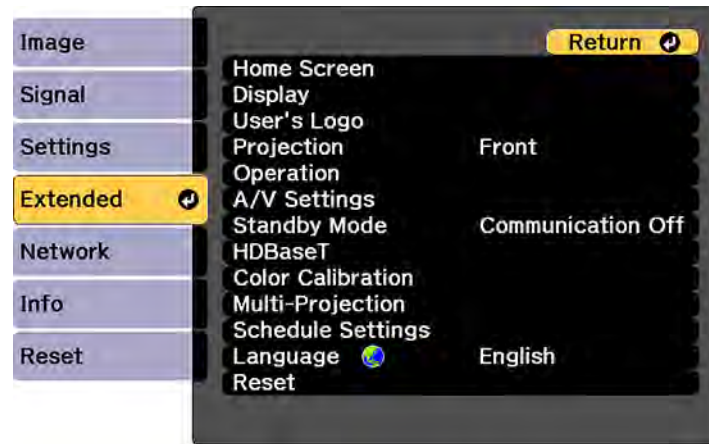

3. Select the **Display** setting and press **Enter**.
4. Select the **Color Uniformity** setting and press **Enter**.
5. Press **Enter** and select **On**.
6. Press **Esc**.
7. Select the **Adjustment Level** setting and press **Enter**.
8. Press the right and left arrow buttons to adjust the level, then press **Esc**.
9. Select the **Start Adjustments** setting and press **Enter**.



10. Select the area of the screen that you want to adjust and press **Enter**.
11. Select the color (**Red**, **Green**, or **Blue**) you want to adjust, and use the left arrow button to weaken the color tone and the right arrow button to strengthen the color tone.
12. Press **Esc**.
13. Repeat steps 10 and 11 for each area you want to adjust.
14. When you are finished, press the **Menu** button.

Parent topic: [Using Advanced Image Adjustment Features](#)

Using Multiple Projectors

You can combine the projected images from two or more projectors to create one large image. Follow the instructions in these sections to setup and project from multiple projectors.

[Multiple Projector Adjustment Overview](#)

[Projector Identification System for Multiple Projector Control](#)

[Tiling Images into One Image](#)

[Blending the Image Edges](#)

[Adjusting the Black Level](#)

[Matching Tint and Brightness \(Screen Matching\)](#)

[Scaling an Image](#)

Parent topic: [Adjusting Projector Features](#)

Multiple Projector Adjustment Overview

If you are combining images from multiple projectors on a network, you can assign one projector as the "master" and automatically adjust all the images to match the "master" image. If the projectors are not connected to a network, you can match each projector's images manually.

Note: Make sure all networked projectors are connected using LAN cables and have been assigned an IP address. Also disable Sleep Mode on each projector so they do not turn off during adjustment.

1. Turn on all the projectors.
2. To select a master projector for automatic adjustment, select **Custom** for the **Light Source Mode** setting and set the **Brightness Level** setting to the maximum value for all projectors. The projector with the darkest projected image is the master projector.

3. Do one of the following:
 - For automatic adjustment, set an ID for the master projector and the remote control.
 - For manual adjustment, set an ID for each projector and the remote control.
4. Adjust each projector's physical position and angle to the screen.
5. Do one of the following:
 - For automatic adjustment, configure tiling automatically.
 - For manual adjustment, configure tiling manually.
6. Adjust the image aspect ratio for each projector.
7. Adjust the position of the image for each projector using lens shift.
8. Adjust the zoom and focus for each projector.
9. Adjust small differences in the images using the **Point Correction** setting.
10. Adjust the edges of the images using the **Edge Blending** and **Black Level** settings.
11. Adjust the brightness and tint of the images using the **Screen Matching** setting.
12. Select sections of the images using the **Scale** setting.

Parent topic: [Using Multiple Projectors](#)

Related concepts

[Wired Network Projection](#)

[Projector Identification System for Multiple Projector Control](#)

[Projector Placement](#)

[Image Aspect Ratio](#)

Related references

[Projector Feature Settings - Settings Menu](#)

Related tasks

[Turning On the Projector](#)

[Adjusting the Image Position Using Lens Shift](#)

[Adjusting the Image Position Using Screen Position](#)

[Resizing the Image with the Zoom Button](#)

[Focusing the Image Using the Focus Button](#)

[Correcting Image Shape with Point Correction](#)

[Blending the Image Edges](#)

[Adjusting the Black Level](#)

[Scaling an Image](#)

Related topics

[Tiling Images into One Image](#)

[Matching Tint and Brightness \(Screen Matching\)](#)

Projector Identification System for Multiple Projector Control

You can operate multiple projectors using one remote control for more elaborate presentations. To do this, you assign an identification number to each projector and to the remote control. Then you can operate all the projectors at once or individually.

You can also match the colors displayed by any projectors you plan to use near each other.

Caution: Leave at least 20 inches (50 cm) of space between the projectors to prevent them from overheating.

[Setting the Projector ID](#)

[Setting the Remote Control ID](#)

Parent topic: [Using Multiple Projectors](#)

Setting the Projector ID

If you want to control multiple projectors from a remote control, give each projector a unique ID.

1. Press the **Menu** button.
2. Select the **Extended** menu and press **Enter**.
3. Select the **Multi-Projection** setting and press **Enter**.
4. Select **Projector ID** and press **Enter**.

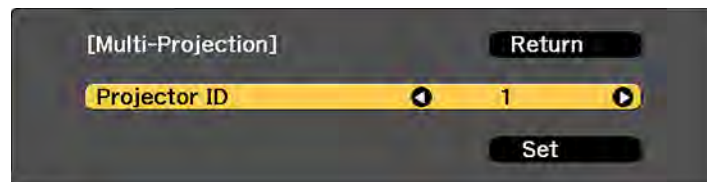

5. Press the left or right arrow buttons on the remote control to select the identification number you want to use for the projector. Then select **Set** and press **Enter**.

Repeat these steps for all the other projectors you want to operate from one remote control.

Note: If you don't know the projector's ID, hold down the **ID** button and press the **Home** button to temporarily display the projector's ID on the screen.

Parent topic: [Projector Identification System for Multiple Projector Control](#)

Setting the Remote Control ID

The remote control's ID is set to **0** by default so it can operate any compatible projector. If you want to set the remote control to operate only a particular projector, you need to set the remote control's ID to match the projector's ID.

1. Turn on the projector you want the remote control to operate with exclusively.
2. Set the remote control **ID** switch to **On**.

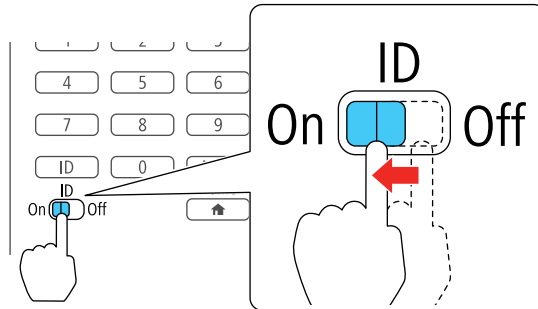

3. Hold down the **ID** button on the remote control while you press the numeric button that matches the projector's ID. Then release the buttons.

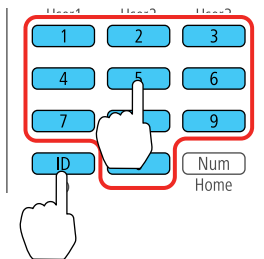

Note: If you don't know the projector's ID, hold down the **ID** button and press the **Home** button to temporarily display the projector's ID on the screen. If the batteries are left out of the remote control for an extended period, the remote control ID returns to its default setting.

Parent topic: [Projector Identification System for Multiple Projector Control](#)

Tiling Images into One Image

You can project the same image from up to nine projectors to create one large image using the Tiling feature.

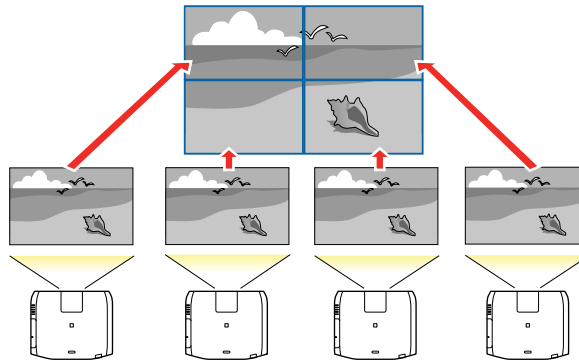

Note: Before tiling, make sure the displayed images from your projectors are rectangular, correctly sized, and focused.

[Configuring Tiling Automatically](#)

[Configuring Tiling Manually](#)

Parent topic: [Using Multiple Projectors](#)

Related tasks

[Multiple Projector Adjustment Overview](#)

Configuring Tiling Automatically

If your projectors are on a network and you have identified a master projector, you can configure tiling automatically.

1. Turn on the projector.

Note: Make sure nothing is blocking the built-in camera on the front of the projector.

2. Press the **Menu** button.
3. Select the **Extended** menu and press **Enter**.
4. Select **Multi-Projection** and press **Enter**.

You see this screen:

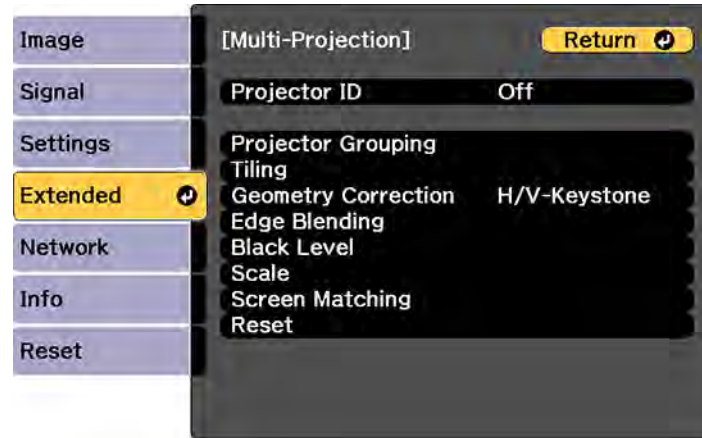

5. Select **Projector Grouping** and press **Enter**.

You see a screen like this:

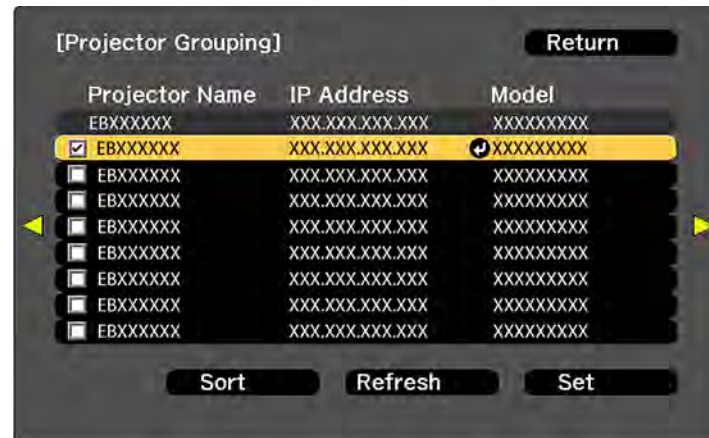

6. Press the up or down arrow buttons to highlight a projector and press **Enter** to place a checkmark next to each projector you want to use for tiling. Then select **Set** and press **Enter**.
7. Select **Tiling** and press **Enter**.
8. Select **Tiling** again and press **Enter**.

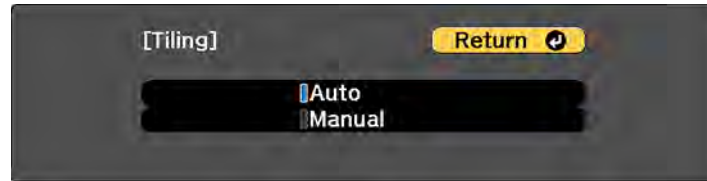

9. Select **Auto** and press **Esc**.
10. Select **Location Setup** and press **Enter**.
The projected images are positioned automatically.
11. When you see the message to assign projector IDs, select **Yes**.
When setup is complete, you see a screen like this:

[Location Info]		
EBXXXXXX XXXXXXXX ID: XX	EBXXXXXX XXXXXXXX ID: XX	EBXXXXXX XXXXXXXX ID: XX
EBXXXXXX XXXXXXXX ID: XX	EBXXXXXX XXXXXXXX ID: XX	EBXXXXXX XXXXXXXX ID: XX

Note: If any of the images are not positioned correctly, select **Manual** in step 9 to locate the image manually.

12. Select the input signal to display an image.

After performing the steps here, adjust the images for any gaps and differences in color.

Note: Do not change any of the projector names or IP addresses, or the images will not be adjusted automatically.

Parent topic: [Tiling Images into One Image](#)

Related references

[Projector Parts - Front/Top](#)

Related tasks

[Configuring Tiling Manually](#)

Configuring Tiling Manually

If your projectors are not on a network or you were unsuccessful tiling the images automatically, you can configure tiling manually.

1. Turn on the projector.
2. Press the **Menu** button.
3. Select the **Extended** menu and press **Enter**.
4. Select **Multi-Projection > Tiling > Layout**.



5. Select the number of rows and columns you are setting up as the **Row** and **Column** settings. Then select **Set** and press **Enter**.
6. Repeat the previous steps with each projector you are setting up before continuing with the next step.

7. Select **Location Setup** and press **Enter**.

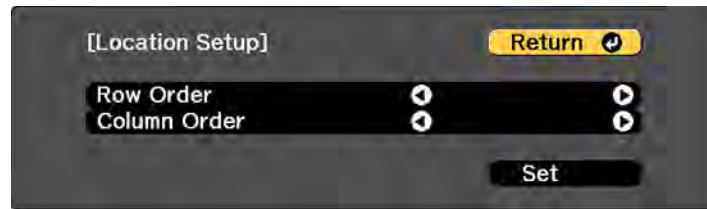

8. Select the position of each projected image as follows:
- **Row Order** to layout the screens from top to bottom in sequential order, starting with **1** at the top
 - **Column Order** to layout the screens from left to right, starting with **A** on the left

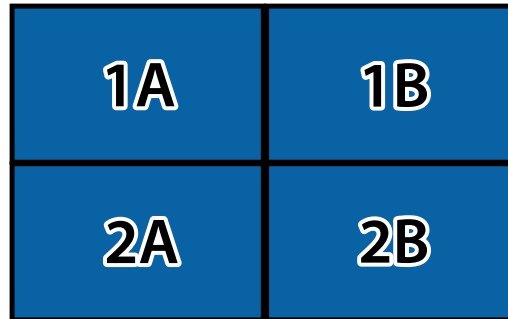

9. Repeat the previous step with each projector you are setting up before continuing with the next step.
10. Select the input signal to display an image.

After performing the steps here, adjust the images for any gaps and differences in color.

Parent topic: [Tiling Images into One Image](#)

Blending the Image Edges

You can use the projector's Edge Blending feature to create a seamless image from multiple projectors.

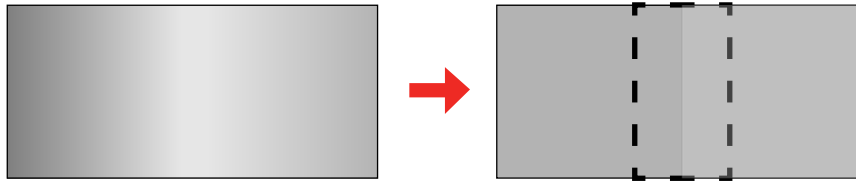

1. Press the **Menu** button.
2. Select the **Extended** menu and press **Enter**.
3. Select the **Multi-Projection** setting and press **Enter**.
4. Select the **Edge Blending** setting and press **Enter**.

You see this screen:

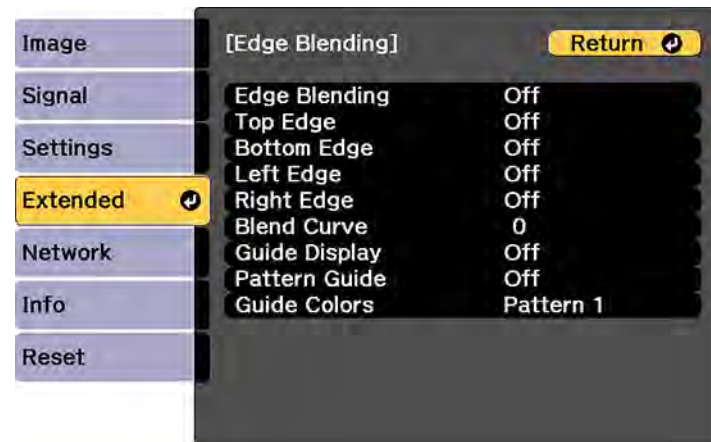

5. Turn on the **Edge Blending**, **Guide Display**, and **Pattern Guide** settings.

Note: If the projected guide is unclear, try changing the **Guide Colors** setting.

6. Select the edge you want to blend and press **Enter**.

You see a screen like this:



7. Select the **Blending** setting and select **On**.
8. Select the **Blend Start Position** setting and adjust the point where edge blending begins.
9. Select the **Blend Range** setting and select the width of the blended area so that the displayed guides are at the edges of the overlapping area between the two images.

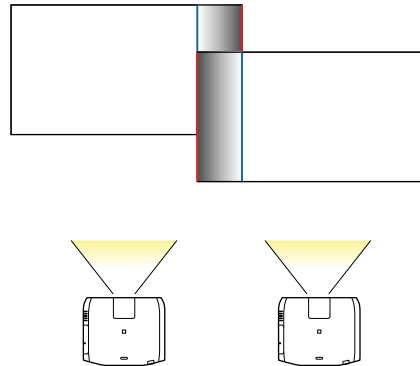

10. Press **Esc** to go back to the previous screen.
11. Select the **Blend Curve** setting and select a gradient for the shaded area.
12. When the edges are blended, turn off the **Guide Display** and **Pattern Guide** settings to check the final settings.
13. When you are finished, press the **Menu** button.

Parent topic: [Using Multiple Projectors](#)

Adjusting the Black Level

When two images overlap, the overlapping area can appear differently from the areas that do not overlap. You can use the projector's Black Level setting to make the difference less noticeable.

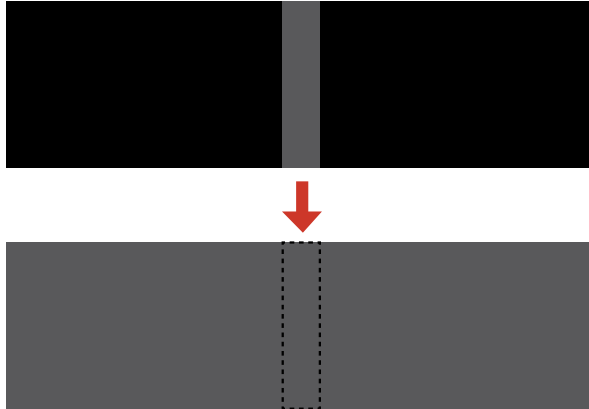

Note: You may not be able to adjust the black levels correctly if the **Geometry Correction** settings are set too high. The brightness and tone of the overlapping areas may differ from the rest of the image even after adjusting the black level.

1. Press the **Menu** button.
2. Select the **Extended** menu and press **Enter**.
3. Select the **Multi-Projection** setting and press **Enter**.
4. Select the **Black Level** setting and press **Enter**.

You see this screen:

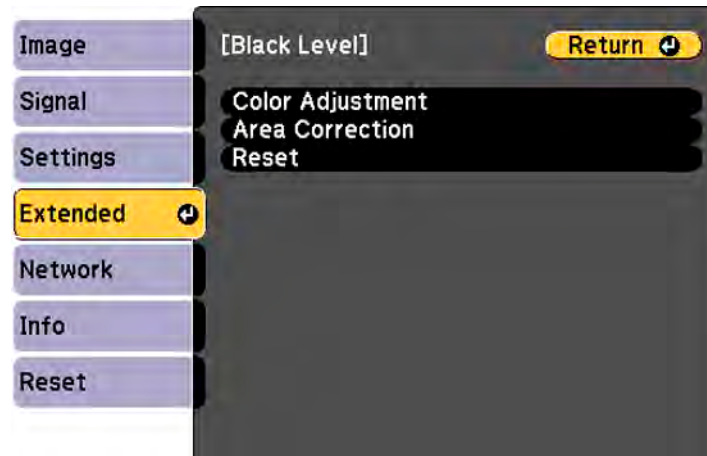

5. Select the **Color Adjustment** setting and press **Enter**.

You see a screen based on the **Top Edge**, **Bottom Edge**, **Right Edge**, and **Left Edge** settings you selected for the **Edge Blending** setting.

Note: The **Color Adjustment** setting is automatically adjusted when selecting **Start Auto Adjustment** in the Screen Matching screen.

6. Select the area you want to adjust and press **Enter**.

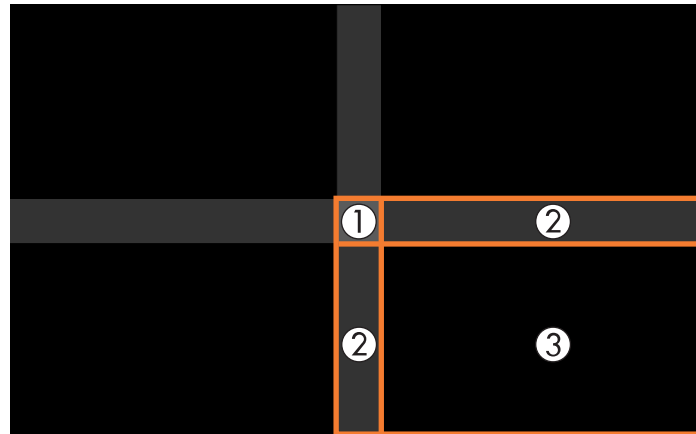

Note: The area you selected is displayed in orange. Adjust overlapping areas starting with the brightest areas first. For example, adjust area 2 to match area 1, then adjust area 3 to match area 2.

7. Adjust the brightness and tone of the areas that do not overlap to match the areas that overlap using the displayed adjustment sliders.
8. Repeat the previous two steps as needed until all areas match.
9. If the tone of some areas do not match, you can adjust them using the **Area Correction** setting. Continue with the next step. Otherwise, go to step 19.
10. Press the **Esc** button to return to the Black Level screen.
11. Select the **Area Correction** setting and press **Enter**.
12. Select the **Start Adjustments** setting and press **Enter**.
You see a screen with boundary lines indicating areas that are overlapping. The boundary lines are based on the **Top Edge**, **Bottom Edge**, **Right Edge**, and **Left Edge** settings you selected for the **Edge Blending** setting.
13. Use the arrow buttons to select a boundary line and press **Enter**.

You see a screen like this displaying the points you can use to set the adjustment range:

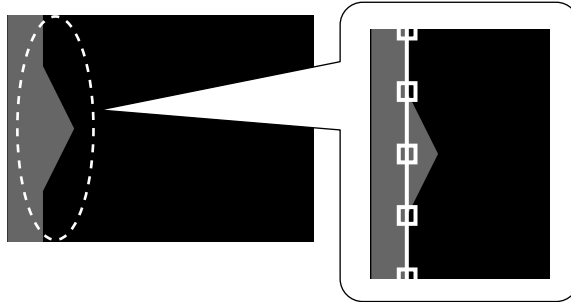

14. Use the arrow buttons to adjust the boundary line position and press the **Enter** button.

15. Use the arrow buttons to select an adjustment point and press the **Enter** button.

The selected point turns orange.

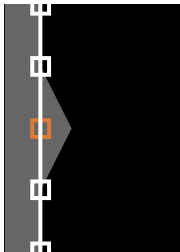

16. Use the arrow buttons to move the point.

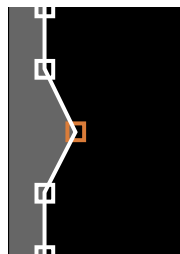

17. To move another point, press the **Esc** button and repeat the previous two steps.
18. To move another boundary line, press the **Esc** button repeatedly until you can select a boundary line.
19. When you are finished, press the **Menu** button.

Note: Changing the **Top Edge**, **Bottom Edge**, **Right Edge**, or **Left Edge** settings resets the **Black Level** setting to its default value.

Parent topic: [Using Multiple Projectors](#)

Related references

[Projector Setup Settings - Extended Menu](#)

Matching Tint and Brightness (Screen Matching)

You can adjust the tint and brightness of multiple projectors so they match better. You can also schedule automatic adjustments to the tint and brightness.

Note: Wait 20 minutes after turning on the projector before using the Screen Matching feature and darken the room for maximum accuracy. Brightness decreases over time, so you may need to perform Screen Matching again to correct large differences in brightness.

[Matching the Screens Automatically](#)

[Matching the Screens Manually](#)

Parent topic: [Using Multiple Projectors](#)

Related tasks

[Saving a Scheduled Event](#)

Matching the Screens Automatically

You can automatically correct the brightness and tint for multiple projectors based on the brightness and tint settings you selected for the master projector.

Before you start, make sure of the following:

- Select **Multi-Projection** for the **Color Mode** setting and adjust the **Brightness**, **Contrast**, **Color Saturation**, **Tint**, **White Balance**, and **Advanced** settings in the Image menu, as necessary, on the master projector.
- You are projecting on a matte white diffusion screen that is flat and even.
- The projected image is between 80 to 200 inches (203 to 508 cm) and is rectangular after tiling.

- All the projectors are connected to a network and the **Location Setup** setting has been configured.
- Nothing is blocking the built-in camera on the front of each projector.

Note: Auto adjustment is not available for the following lenses: ELPLX01, ELPLR04, ELPLM11, ELPLM07, ELPLL08, ELPLL07 (Pro L1100U/L1200U/L1300U/L1405U) and ELPLR04, ELPLL08, ELPLL07 (Pro L1500U/L1505U). After auto adjustment, the movement range for lens shift is reduced.

1. Press the **Menu** button.
2. Select the **Extended** menu and press **Enter**.
3. Select the **Multi-Projection** setting and press **Enter**.
4. Select the **Screen Matching** setting and press **Enter**.
5. Select **Start Auto Adjustment** press **Enter**.

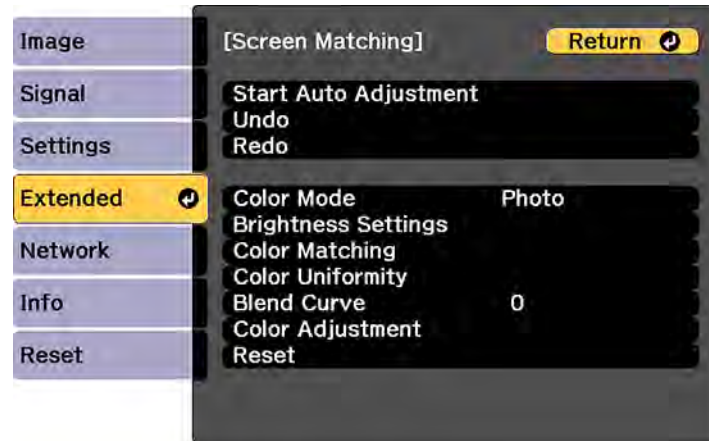

When adjustment starts, you see an adjustment pattern. Adjustment is complete when you see a displayed image.

After automatic adjustment, the **Color Uniformity** and **Color Matching** settings are returned to their default values.

Parent topic: [Matching Tint and Brightness \(Screen Matching\)](#)

Related concepts

[Color Mode](#)

Related references

[Image Quality Settings - Image Menu](#)

[Projector Parts - Front/Top](#)

Related tasks

[Multiple Projector Adjustment Overview](#)

[Configuring Tiling Automatically](#)

Matching the Screens Manually

You can manually correct the brightness and tint for multiple projectors.

1. Press the **Menu** button.
2. Select the **Extended** menu and press **Enter**.
3. Select the **Multi-Projection** setting and press **Enter**.
4. Select the **Screen Matching** setting and press **Enter**.

You see this screen:

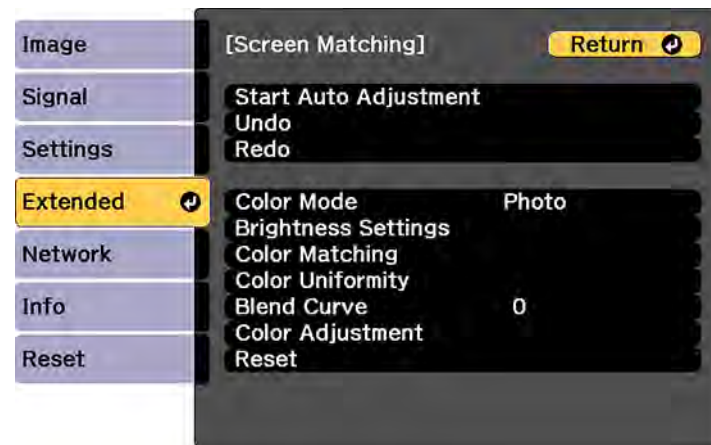

5. Select the **Color Matching** setting and press **Enter**.

You see this screen:



6. Press the left or right arrow buttons to select a value for the **Adjustment Level** setting.

Note: There are eight adjustment levels ranging from white to black and you can adjust each level individually.

7. Press the left or right arrow buttons to adjust the color tone for the **Red**, **Green**, and **Blue** settings.
8. Press the left or right arrow buttons to adjust the **Brightness** setting.
9. Repeat the previous three steps as necessary to adjust each adjustment level.

Parent topic: [Matching Tint and Brightness \(Screen Matching\)](#)

Scaling an Image

You can project the same image from multiple projectors and use the Scale feature to crop and combine them into one large image.

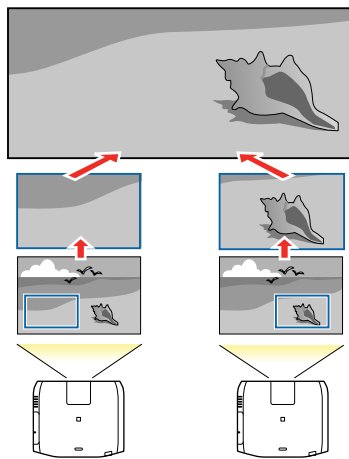

1. Press the **Menu** button.
2. Select the **Extended** menu and press **Enter**.
3. Select the **Multi-Projection** setting and press **Enter**.
4. Select the **Scale** setting and press **Enter**.

You see this screen:



5. Select one of the following as the **Scale** setting:
 - **Auto** to automatically adjust the clipped areas according to the **Edge Blending** and **Tiling** settings you selected
 - **Manual** to adjust the clipped areas manually
6. Select the **Scale Mode** setting and select one of these options:
 - **Zoom Display** to maintain the image aspect ratio as you scale the image

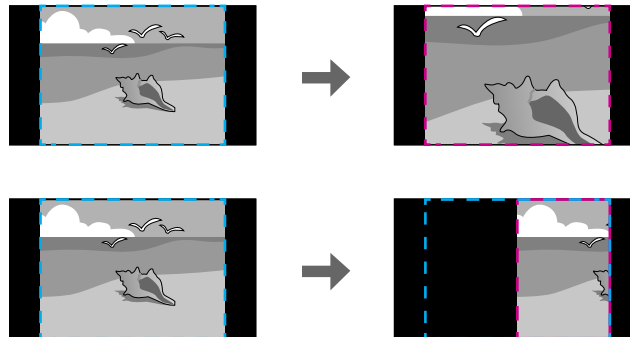

- **Full Display** to adjust the image to the projector's screen size as you scale the image

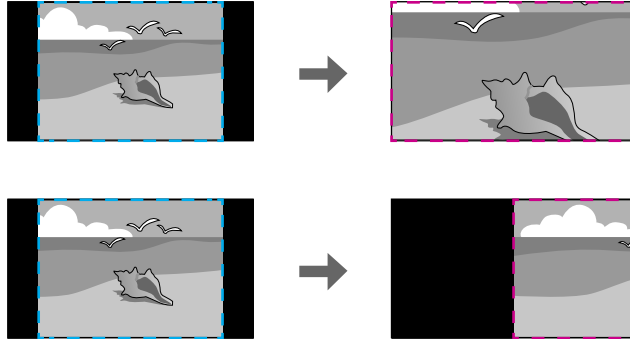

7. If you selected **Auto** as the Scale setting, you can skip the remaining steps. If you selected **Manual**, adjust each of the following options as necessary:
 - – or + to scale the image horizontally and vertically at the same time
 - **Scale Vertically** to scale the image vertically only
 - **Scale Horizontally** to scale the image horizontally only
8. Select the **Clip Adjustment** setting and use the arrow buttons to adjust the coordinates and size of each image as you view the screen.
9. When you are finished, press the **Menu** button.

Parent topic: [Using Multiple Projectors](#)

Enabling Protocol Emulation

You can use protocol emulation to control your projector with the same RS-232 control codes as those used by the manufacturers of other projectors. This lets you control a group of projectors from a common controller.

1. Make sure the projector is turned on.
2. Connect a controller to the RS-232C port on the projector.
3. Do one of the following:
 - Press and hold the **Test Pattern** button on the remote control for at least five seconds.
 - Select the **Extended** menu, highlight the **Standby Mode** setting, and hold down the right arrow button on the remote control or projector control panel for at least five seconds.

You see the Protocol Emulation screen.

4. Select one of the following and press **Enter**:
 - **Type P** for Panasonic projectors
 - **Type M** for Mitsubishi projectors
 - **Type N** for NEC projectors
 - **Type S** for Sony projectors
5. Turn the projector off and on again to enable the control code you selected.

Parent topic: [Adjusting Projector Features](#)

Viewing 3D Images

You can use two projectors to project and view passive 3D images.

The following optional items are required:

- Polarizer
- Passive 3D glasses
- A mount to stack the projectors
- Silver screen designed for passive 3D images

See the instructions supplied with the optional equipment for setup and use.

Parent topic: [Adjusting Projector Features](#)

Related references

[Optional Equipment and Replacement Parts](#)

Saving Settings to Memory and Using Saved Settings

You can save customized settings and then select the saved settings whenever you want to use them.

1. Turn on the projector and display an image.
2. Press the **Menu** button.

3. Select the **Settings** menu and press **Enter**.

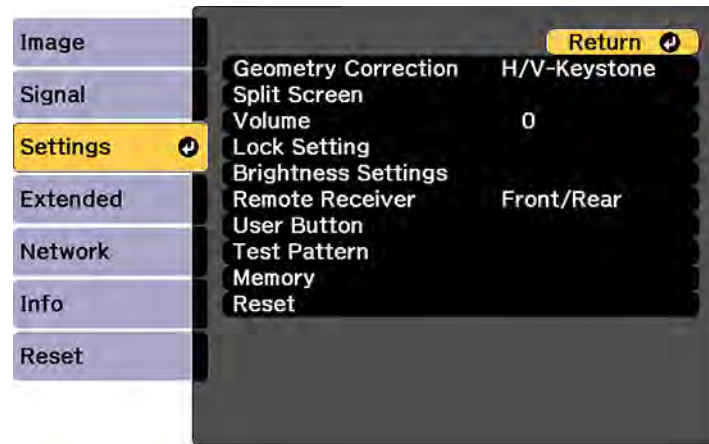

4. Select the **Memory** setting and press **Enter**.

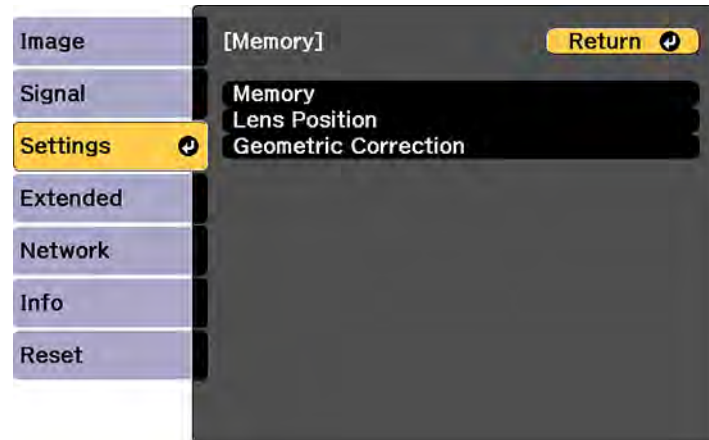

Note: You can also access this screen by pressing the **Memory** button on the remote control.

5. Select one of the following options:
 - **Memory:** Saves or loads various settings; you can save up to 10 different memories

Note: The following settings are saved: all settings from the Image menu, the **Scale** setting from the Signal menu, and the **Edge Blending**, **Black Level**, and **Color Matching** settings from the Extended menu.

- **Lens Position:** Saves or loads settings related to the lens such as the lens shift, focus, zoom, and distortion adjustment settings; you can save up to 10 different memories
- **Geometry Correction:** Saves or loads any adjustments made in the **Geometry Correction** setting in the Settings menu; you can save up to 3 different memories

You see this screen:

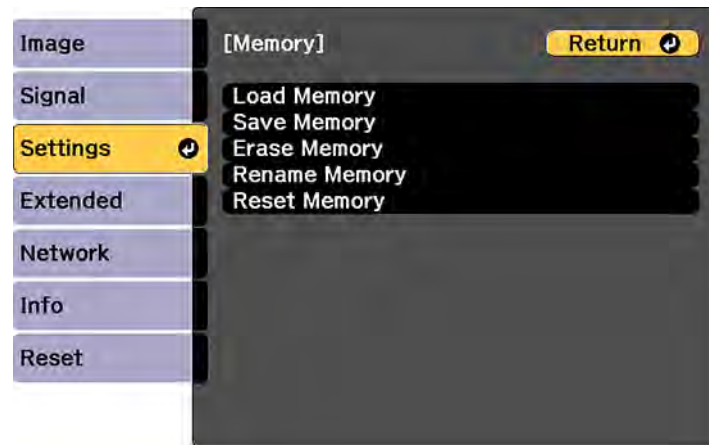

6. Select one of the following options:

- **Load Memory:** Overwrites your current settings with saved settings
- **Save Memory:** Saves your current settings to memory

Note: A memory name that has already been used is indicated by a blue mark. Saving over a previously saved memory overwrites the settings with your current settings.

- **Erase Memory:** Erases the selected memory settings
- **Rename Memory:** Renames a saved memory
- **Reset Memory:** Resets the name and settings of a saved memory

Note: To reset all saved memories of all types, select **Reset All Memories** in the Reset menu.

7. Press **Menu** or **Esc** to exit.

Parent topic: [Adjusting Projector Features](#)

Saving a Scheduled Event

You can select projector commands you want to perform and schedule them as an event.

1. Press the **Menu** button.
2. Select the **Extended** menu and press **Enter**.
3. Select the **Schedule Settings** setting and press **Enter**.
The Schedule Settings screen appears.
4. Select the **Schedule** menu and press **Enter**.
5. Select **Add New** and press **Enter**.
6. In the Event Settings section, select the events you want to have occur. (Select **No Change** for events that you do not want to occur.)

Note: You cannot schedule an event to occur at the following times: five minutes before or after a Color Calibration event, or five minutes before or 30 minutes after a Screen Matching event. Light Source Calibration events do not start if the projector is used continuously for more than 24 hours, or regularly turned off by shutting off the power outlet. Set **Light Source Calibration** events to occur only after 100 hours of usage.

7. In the Date/Time Settings section, set the date and time for the scheduled events to occur.
8. When you are finished, select **Save** and press **Enter**.
9. To schedule more events, repeat the previous steps as necessary.
10. Select **Setup complete** and select **Yes** to save your changes.

[Viewing Scheduled Events](#)

[Editing a Scheduled Event](#)

Parent topic: [Adjusting Projector Features](#)

Viewing Scheduled Events

You can view any currently scheduled events.

1. Press the **Menu** button.
2. Select the **Extended** menu and press **Enter**.
3. Select the **Schedule Settings** setting and press **Enter**.

You see a screen like this:

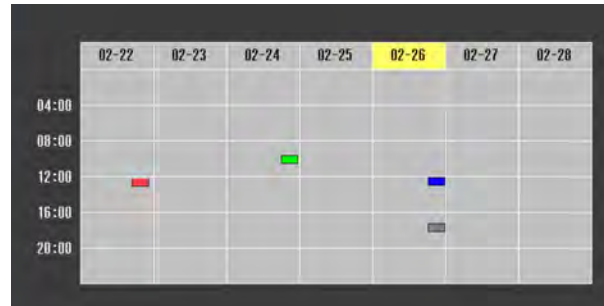

The colored boxes in the calendar indicate the following about the scheduled events:

- One-time event
- Reoccurring event
- Communication is on/off
- Event is invalid

Parent topic: [Saving a Scheduled Event](#)

Editing a Scheduled Event

You can edit any currently scheduled event.

1. Press the **Menu** button.
2. Select the **Extended** menu and press **Enter**.
3. Select the **Schedule Settings** setting and press **Enter**.

You see a screen like this:

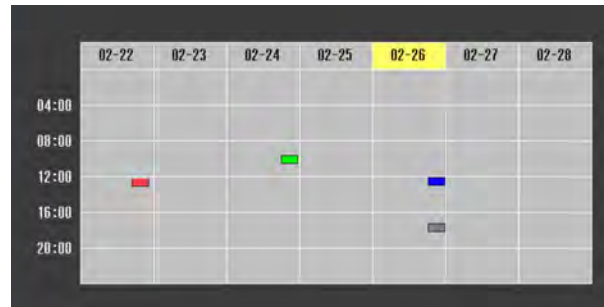

4. Press the left or right arrow buttons to highlight the date on the calendar containing the scheduled event you want to edit.
5. Press the up or down arrow buttons to highlight the event you want to edit, and press **Esc**.
6. Select one of the following:
 - **On/Disabled**: Enable or disable the selected event.
 - **Edit**: Edit the settings for the selected event.
 - **Clear**: Delete the selected event.
 - **Add New**: Add a new scheduled event.
7. When you are finished, select **Return** and press **Enter**.
8. Select **Setup complete** and select **Yes** to save your changes.

Note: To delete all scheduled events, select **Schedule Reset** and select **Yes**.

Parent topic: [Saving a Scheduled Event](#)

Copying Menu Settings Between Projectors

After you select menu settings for your projector, you can transfer them to another projector of the same model.

Note: Copy the projector's settings before you adjust the projected image using the projector's Geometry Correction settings. Any saved User's Logo setting on the projector will transfer to the other projector.

Caution: If the copy process fails due to a power failure, communication error, or for any other reason, Epson will not be responsible for any repair costs incurred.

The following settings will not transfer between projectors:

- Info menu items
- Network menu settings other than those in the Mail and Others menus
- Network menu settings other than those in the Notifications and Others menus

Note: In addition to the methods covered this section, you can also copy and transfer settings to multiple projectors over a network using the EasyMP Network Updater software. See the *EasyMP Network Updater Operation Guide* for instructions. You can download the latest software and documentation from the Epson web site.

[Saving Settings to a USB Flash Drive](#)

[Transferring Settings From a USB Flash Drive](#)

[Saving Settings to a Computer](#)

[Transferring Settings From a Computer](#)

Parent topic: [Adjusting Projector Features](#)

Related references

[Projector Information Display - Info Menu](#)

[Projector Network Settings - Network Menu](#)

[Additional Projector Software and Manuals](#)

Saving Settings to a USB Flash Drive

You can save the projector settings you want to transfer to a USB flash drive.

Note: Use an empty flash drive. If the drive contains other files, the transfer may not complete correctly.

1. Turn off the projector and unplug the power cord from the projector's power inlet.

2. Insert the flash drive into the wireless LAN module port.

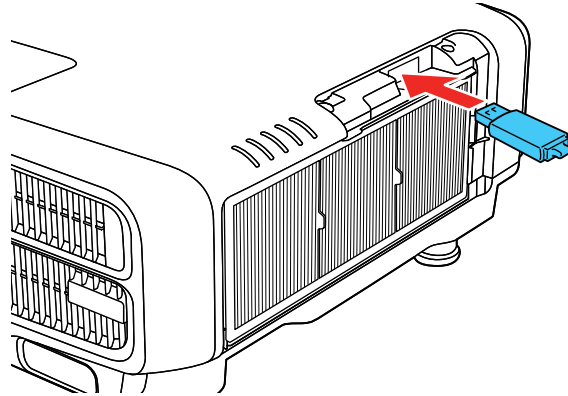

Note: Connect the flash drive directly to the projector. Do not use a hub or your settings may not be saved correctly.

3. Press and hold the **Esc** button on the control panel or remote control as you connect the power cord to the projector's power inlet.

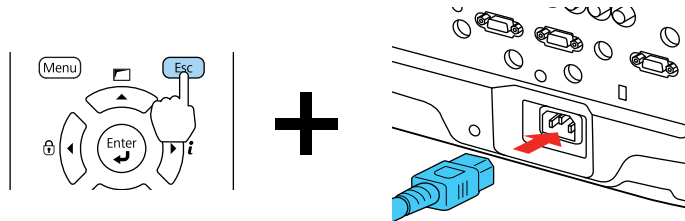

4. When the On/Standby and Status lights are blue, and the Laser and Temp lights are orange, release the **Esc** button.

The lights flash to indicate that settings are transferring to the flash drive. When the lights stop flashing, the On/Standby light turns blue and the projector enters standby mode.

Caution: Do not unplug the power cord or remove the flash drive while the lights are flashing. This could damage the projector.

5. Once the projector enters standby mode, remove the flash drive.

Parent topic: [Copying Menu Settings Between Projectors](#)

Transferring Settings From a USB Flash Drive

After saving projector settings to a USB flash drive, you can transfer them to another projector of the same model.

Note: Make sure the USB flash drive contains only a single settings transfer from another projector of the same model. The settings are contained in a file called **pjconfdata.bin**. If the drive contains other files, the transfer may not complete correctly.

Do not adjust image settings on a projector until after you transfer settings to it. Otherwise, you may have to repeat your adjustments.

1. Turn off the projector and unplug the power cord from the projector's power inlet.
2. Insert the flash drive into the wireless LAN module port.

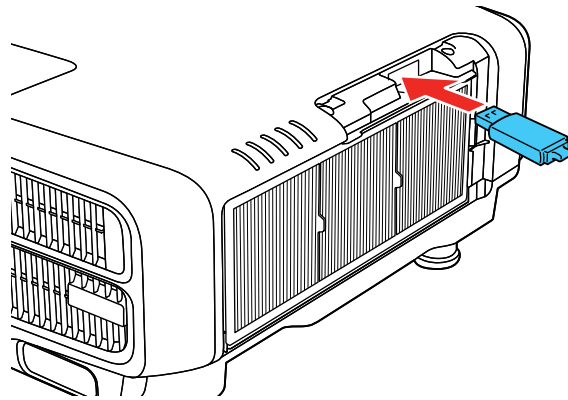

Note: Connect the flash drive directly to the projector. Do not use a hub or your settings may not be saved correctly.

3. Press and hold the **Menu** button on the control panel or remote control as you connect the power cord to the projector's power inlet.

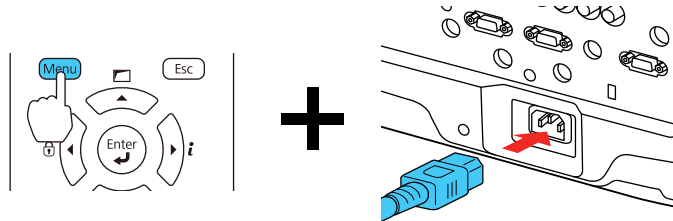

4. When the On/Standby and Status lights are blue, and the Laser and Temp lights are orange, release the **Menu** button.

The lights flash to indicate that settings are transferring to the projector. When the lights stop flashing, the On/Standby light turns blue and the projector enters standby mode.

Caution: Do not unplug the power cord or remove the flash drive while the lights are flashing. This could damage the projector.

5. Once the projector enters standby mode, remove the flash drive.

Parent topic: [Copying Menu Settings Between Projectors](#)

Saving Settings to a Computer

You can save the projector settings you want to transfer to a computer.

Your computer must be running one of the following operating systems:

- Windows Vista
- Windows 7
- Windows 8.x
- Windows 10
- OS X 10.5.8
- OS X 10.6.x
- OS X 10.7.x
- OS X 10.8.x

- OS X 10.9.x
 - OS X 10.10.x
 - OS X 10.11.x
1. Turn off the projector and unplug the power cord from the projector's power inlet.
 2. Connect a USB cable to your projector's **Service** port.

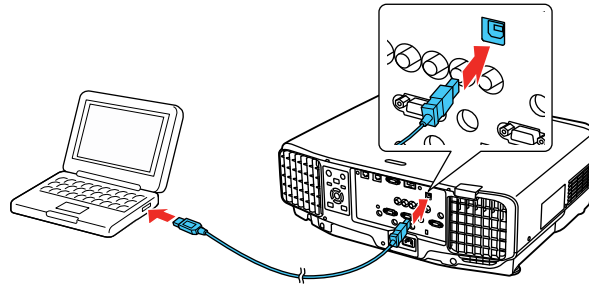

3. Connect the other end to any available USB port on your computer.
4. Press and hold the **Esc** button on the control panel or remote control as you connect the power cord to the projector's power inlet.

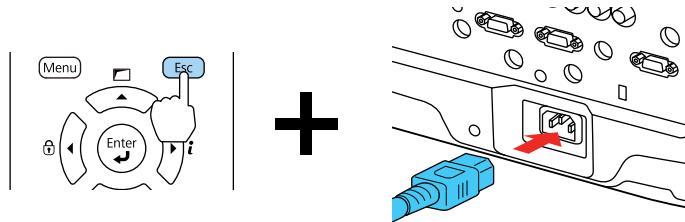

5. When the On/Standby and Status lights are blue, and the Laser and Temp lights are orange, release the **Esc** button.
The projector shows up as a removable disk on your computer.
6. Open the removable disk and copy the **pjconfdata.bin** file to your computer.

7. Once the file has copied, do one of the following:
 - **Windows:** Open the **My Computer**, **Computer**, or **Windows Explorer** utility. Right-click the name of your projector (listed as a removable disk) and select **Eject**.
 - **OS X:** Drag the removable disk icon for your projector from the desktop into the trash.

The projector enters standby mode.

Parent topic: [Copying Menu Settings Between Projectors](#)

Transferring Settings From a Computer

After saving projector settings to a computer, you can transfer them to another projector of the same model.

Your computer must be running one of the following operating systems:

- Windows Vista
- Windows 7
- Windows 8.x
- Windows 10
- OS X 10.5.8
- OS X 10.6.x
- OS X 10.7.x
- OS X 10.8.x
- OS X 10.9.x
- OS X 10.10.x
- OS X 10.11.x

Do not adjust image settings on a projector until after you transfer settings to it. Otherwise, you may have to repeat your adjustments.

1. Turn off the projector and unplug the power cord from the projector's power inlet.

2. Connect a USB cable to your projector's port.

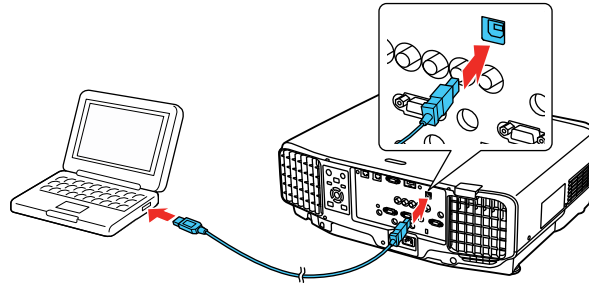

3. Connect the other end to any available USB port on your computer.
4. Press and hold the **Menu** button on the control panel or remote control as you connect the power cord to the projector's power inlet.

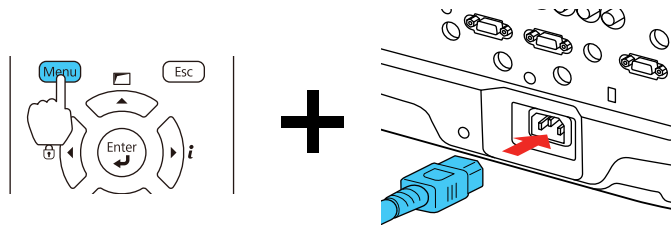

5. When the On/Standby and Status lights are blue, and the Laser and Temp lights are orange, release the **Menu** button.

The projector shows up as a removable disk on your computer.

6. Copy the **pjconfdata.bin** file from your computer to the removable disk.

Note: Do not copy any other files to the removable disk.

7. Once the file has copied, do one of the following:
 - **Windows:** Open the **My Computer**, **Computer**, or **Windows Explorer** utility. Right-click the name of your projector (listed as a removable disk) and select **Eject**.
 - **OS X:** Drag the removable disk icon for your projector from the desktop into the trash.

All the lights start flashing to indicate that the projector's settings are being updated. When the lights stop flashing, the On/Standby light turns blue and the projector enters standby mode.

Caution: Do not unplug the power cord while the lights are flashing. This could damage the projector.

Parent topic: [Copying Menu Settings Between Projectors](#)

Adjusting the Menu Settings

Follow the instructions in these sections to access the projector menu system and change projector settings.

[Using the Projector's Menus](#)

[Image Quality Settings - Image Menu](#)

[Input Signal Settings - Signal Menu](#)

[Projector Feature Settings - Settings Menu](#)

[Projector Setup Settings - Extended Menu](#)

[Projector Network Settings - Network Menu](#)

[Projector Information Display - Info Menu](#)

[Projector Reset Options - Reset Menu](#)

Using the Projector's Menus

You can use the projector's menus to adjust the settings that control how your projector works. The projector displays the menus on the screen.

1. Press the **Menu** button on the control panel or remote control.

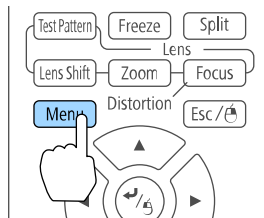

You see the menu screen displaying the Image menu settings.

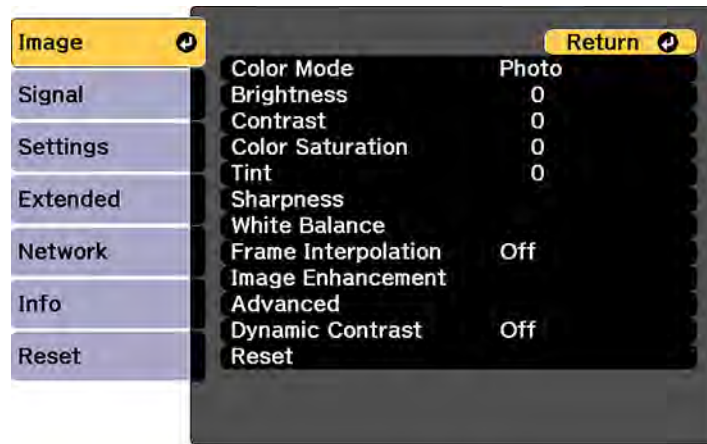

2. Press the up or down arrow button to move through the menus listed on the left. The settings for each menu are displayed on the right.

Note: The available settings depend on the current input source.

3. To change settings in the displayed menu, press **Enter**.
4. Press the up or down arrow button to move through the settings.
5. Change the settings using the buttons listed on the bottom of the menu screens.
6. To return all the menu settings to their default values, select **Reset**.
7. When you finish changing settings on a menu, press **Esc**.
8. Press **Menu** or **Esc** to exit the menus.

Parent topic: [Adjusting the Menu Settings](#)

Image Quality Settings - Image Menu

Settings on the Image menu let you adjust the quality of your image for the input source you are currently using. The available settings depend on the currently selected input source.

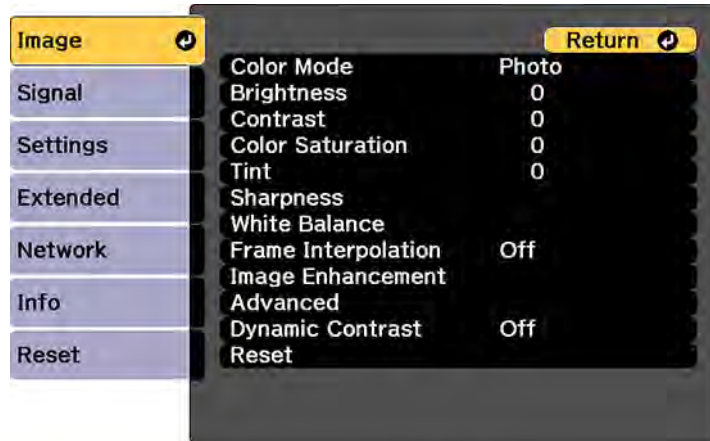

To change settings for an input source, make sure the source is connected and select that source.

Setting	Options	Description
Color Mode	See the list of available Color Modes	Adjusts the vividness of image colors for various image types and environments
Brightness	Varying levels available	Lightens or darkens the overall image
Contrast	Varying levels available	Adjusts the difference between light and dark areas of the image
Color Saturation	Varying levels available	Adjusts the intensity of the image colors
Tint	Varying levels available	Adjusts the balance of green to magenta tones in the image

Setting	Options	Description
Sharpness	Standard Thin Line Enhancement Thick Line Enhancement	Adjusts the sharpness of image details Standard: adjusts the overall image sharpness Thin Line Enhancement: enhances fine details such as hair and fabric patterns Thick Line Enhancement: enhances the outline, background, and main parts of an image to make them more clear
White Balance	Color Temp. G-M Correction Customized	Adjusts the overall tint of the image Color Temp.: sets the color tone based on color temperature G-M Correction: higher values tint the image blue and lower values tint the image red Customized: lets you adjust the offset and gain of each color R (red), G (green), and B (blue) individually
Frame Interpolation	Off Low Normal High	Smooths fast moving video by comparing consecutive frames and inserting an intermediate frame between them

Setting	Options	Description
Image Enhancement	4K Enhancement	Accepts 4K signals and enhances the output of 1080p signals
	Image Preset Mode	Selects the image enhancement settings saved in advance
	Noise Reduction	Reduces flickering in analog images
	MPEG Noise Reduction	Reduces the noise or artifacts seen in MPEG video
	Super resolution	Sharpens blurred images resulting from increasing resolution
	Detail enhancement	Enhances details to create clear outlines Range: higher settings increase the affected area around the outline Strength: higher settings create a stronger effect
Advanced	Gamma	Adjusts the gamma levels of the image. Select Customized to adjust the gamma while viewing the image or a graph.
	RGBCMY	Adjusts the hue, saturation, and brightness for each color
	Deinterlacing	Sets whether to convert interlaced-to-progressive signals for certain video image types Off: for fast-moving video images Video: for most video images Film/Auto: for movies, computer graphics, and animation

Setting	Options	Description
Dynamic Contrast	Off Normal High Speed	Adjusts the luminance of the image to improve contrast by tracking changes in image brightness Normal: for standard brightness adjustment High Speed: to adjust brightness as soon as the scene changes

Note: The **Brightness** setting does not affect laser brightness. To change the laser brightness, use the **Brightness Settings** in the Settings menu.

Parent topic: [Adjusting the Menu Settings](#)

Related references

[Available Color Modes](#)

Input Signal Settings - Signal Menu

Normally the projector detects and optimizes the input signal settings automatically. If you need to customize the settings, you can use the Signal menu. The available settings depend on the currently selected input source.

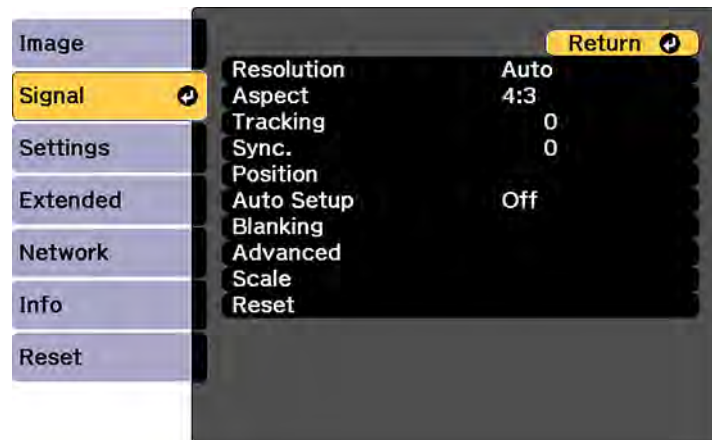

Note: You can restore the default settings of the **Position**, **Tracking**, and **Sync** settings by pressing the **Auto** button on the remote control.

To change settings for an input source, make sure the source is connected and select that source.

Setting	Options	Description
Resolution	Auto Normal Wide Manual	Sets the input signal resolution from an analog RGB computer connection Auto: detects the resolution automatically Normal: for 4:3 or 5:4 screens Wide: for widescreen Manual: allows you to specify a resolution
Aspect	See the list of available aspect ratios	Sets the aspect ratio (width-to-height ratio) for the selected input source
Tracking	Varying levels available	Adjusts signal to eliminate vertical stripes in images from an analog RGB computer connection
Sync.	Varying levels available	Adjusts signal to eliminate fuzziness or flickering in images from an analog RGB computer connection
Position	Up, down, left, right	Adjusts the image location on the screen
Auto Setup	On Off	Automatically optimizes image quality from an analog RGB computer connection (when On)
Blanking	Up, down, left, right	Hides an area of the projected image that you select using the arrow buttons

Setting	Options	Description
Advanced	Video Range	Sets the video range to match the setting of the device connected to the HDMI , DVI-D , HDBaseT , or SDI (L1405U/L1500U/L1505U) input ports
	Input Signal	Specifies the signal type from input sources connected to computer ports Auto : detects signals automatically RGB : corrects color for computer/RGB video inputs Component : corrects color for component video inputs
	Image Processing	Adjusts how images are processed Fast : to display images quicker Fine : to display images in higher quality
Scale	Various scale options	When using multiple projectors to project one image, adjusts the scale of the image displayed by each projector

Parent topic: [Adjusting the Menu Settings](#)

Related references

[Available Image Aspect Ratios](#)

Projector Feature Settings - Settings Menu

Options on the Settings menu let you customize various projector features.

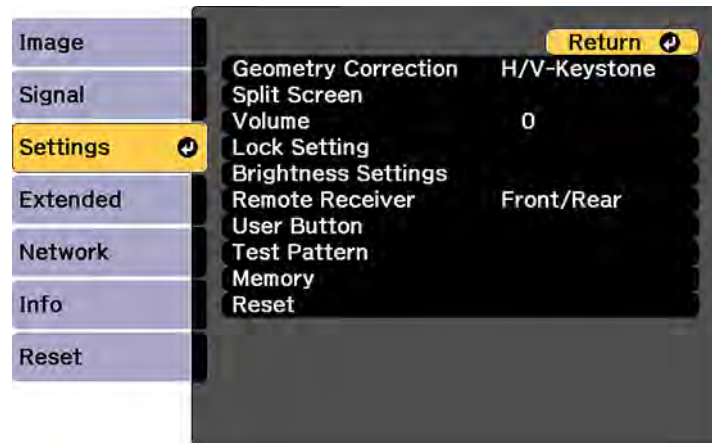

Setting	Options	Description
Geometry Correction	H/V-Keystone Quick Corner Curved Surface Corner Wall Point Correction Memory	Adjusts the projected image shape H/V Keystone: lets you manually correct the angles of the horizontal and vertical sides Quick Corner: select to adjust the position of the four corners Curved Surface: select to adjust the image when projecting on a curved surface Corner Wall: select to adjust the image when projecting on a surface with a right angle Point Correction: select to display a grid and finely adjust the image position Memory: select to save adjustment value of the geometric correction and load it when needed
Split Screen	—	Divides the viewing area horizontally and displays two images side-by-side; while in Split Screen mode, press Menu to display the Split Screen options or Esc to cancel split screen display
Volume	Varying levels available	Adjusts the volume of the projector's speaker system

Setting	Options	Description
Lock Setting	Control Panel Lock Lens Lock	Controls projector button locking to secure the projector Control Panel Lock: <ul style="list-style-type: none"> • Full Lock: locks all buttons • Partial Lock: locks all buttons except the power button • Off: no buttons locked Lens Lock: locks the focus, zoom, and lens shift settings

Setting	Options	Description
Brightness Settings	Light Source Mode Brightness Level Constant Brightness Estimated Remains	Selects the brightness mode of the projector Light Source Mode: sets the brightness for the light source <ul style="list-style-type: none"> • Normal: maximum brightness • Quiet: 70% brightness with reduced fan noise • Extended: 70% brightness and extends the life expectancy of the light source • Custom: select a custom brightness level Brightness Level: select the Custom brightness level you want ¹ Constant Brightness: maintains a constant brightness; enabling this setting prevents you from changing the Light Source Mode and Brightness Level settings ¹ Estimated Remains: displays how long the projector can maintain constant brightness ²
Remote Receiver	Front/Rear Front Rear Off	Limits reception of remote control signals by the selected receiver; Off turns off all receivers
User Button	User1 User2 User3	Assigns a menu option to the User1 , User2 , and User3 buttons on the remote control for one-touch access

Setting	Options	Description
Test Pattern	—	Displays a test pattern to assist in adjusting the image; press the left or right arrow buttons on the remote control or Enter on the control panel to cycle through the available test patterns, or Esc to cancel pattern display
Memory	Load Memory Save Memory Erase Memory Rename Memory	Save customized sets of settings to memory

¹ Available only when the **Light Source Mode** setting is set to **Custom**.

² Available only when the **Light Source Mode** setting is set to **Custom** and the **Constant Bright** setting is set to **On**.

Parent topic: [Adjusting the Menu Settings](#)

Projector Setup Settings - Extended Menu

Settings on the Extended menu let you customize various projector setup features that control its operation.

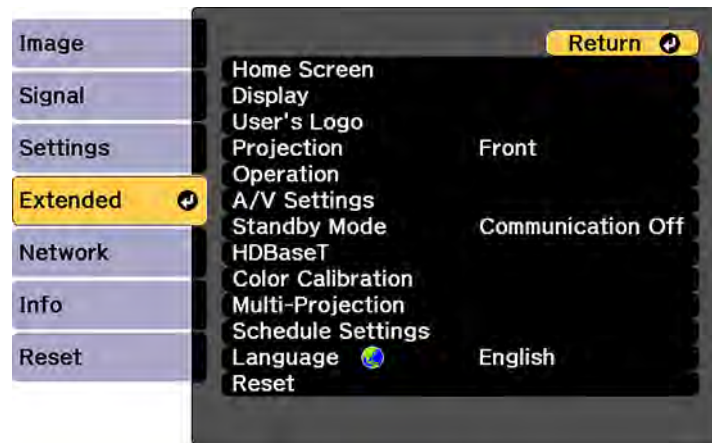

Setting	Options	Description
Home Screen	—	Adjust settings on the Home Screen
Display	—	See the Display settings table in this topic
User's Logo	—	Creates a screen that the projector displays to identify itself and enhance security
Projection	Front Front/Ceiling Rear Rear Ceiling	Selects the way the projector faces the screen so the image is oriented correctly
Operation	—	See the Operation settings table in this topic
A/V Settings	A/V Output Monitor Out Audio Settings	<p>Selects various audio and video output settings</p> <p>A/V Output: select to output audio and video to an external device when the projector is in standby mode (Standby Mode must be turned on to use this setting)</p> <p>Monitor Out: select the image source to output to an external device when the projector is in standby mode; when set to Auto, selects output from the Computer or BNC port depending on which was used when the projector went into standby mode</p> <p>Audio Settings: selects audio source to output</p>

Setting	Options	Description
Standby Mode	Communication On Communication Off	<p>Enable this setting to allow the following operations to occur when the projector is in standby mode:</p> <ul style="list-style-type: none"> • Monitor and control the projector over a network • Output audio and video to an external device (A/V Output must be set to Always On) • Communication from the HDBaseT port (Control Communications must be set to On)
HDBaseT	Control Communications Extron XTP	<p>Selects the communication settings for connections to an HDBaseT transmitter or switcher</p> <p>Control Communications: enables or disables communication from the Ethernet and serial ports on the transmitter; turning on this setting disables the projector's LAN, RS-232C, and Remote ports (Extron XTP must be turned off to use this setting)</p> <p>Extron XTP: set to On when you connect an Extron XTP transmitter or switcher to the HDBaseT ports</p>

Setting	Options	Description
Color Calibration	Start Auto Adjustment Undo Redo Color Uniformity	<p>Automatically detects color deterioration and adjusts the color tone</p> <p>Start Auto Adjustment: automatically adjusts the color tone for the whole image</p> <p>Undo and Redo: undoes or redoes the auto adjustment</p> <p>Color Uniformity: adjusts the color tone balance for the whole image</p>

Setting	Options	Description
Multi-Projection	Projector ID Projector Grouping Tiling Geometry Correction Edge Blending Black Level Scale Screen Matching	<p>Select various options when projecting from multiple projectors</p> <p>Projector ID: sets the projector to a particular ID number which allows you to use a remote control to individually control projectors</p> <p>Projector Grouping: lets you select the projectors being used to project one image</p> <p>Tiling: sets the number of split screens and the position of each image</p> <p>Geometry Correction: corrects image distortion</p> <p>Edge Blending: blends the border between multiple images to create a seamless screen</p> <p>Black Level: adjusts the brightness and tone differences in overlapping images</p> <p>Scale: adjusts the scale of the images</p> <p>Screen Matching: adjusts the tint and brightness of the images</p>
Schedule Settings	Various scheduling options	Lets you schedule various projector tasks
Language	Various languages available	Selects the language for projector menu and message displays (not changed by Reset option)

Display settings

Setting	Description
Menu Position	Selects the position of the projector menu displayed on the screen
Message Position	Selects the position of messages displayed on the screen
Messages	Controls whether messages are displayed on the screen
Display Background	Selects the screen color or logo to display when no signal is received
Startup Screen	Controls whether a special screen appears when the projector starts up
Standby Confirmation	Displays a confirmation message after pressing the Standby button on the remote control
Air Filter Notice	Displays a message when a clog in the air filter is detected
Screen	Sets the aspect ratio and position of the projected image according to the type of screen being used
Panel Alignment	Corrects color misalignment in the projected image
Color Uniformity	Adjusts the color tone balance
OSD Rotation	Rotates the menu display 90°

Operation settings

Setting	Description
Direct Power On	Turns on the projector when you plug it in
Sleep Mode	Automatically places the projector in standby mode after an interval of inactivity
Sleep Mode Timer	Sets the time before the projector automatically turns off (Sleep Mode must be turned on)
High Altitude Mode	Regulates the projector's operating temperature at altitudes above 4921 feet (1500 m)
Auto Source Search	Automatically select an input source
Auto Power On	If Computer or BNC is selected, the projector turns on when an input signal is detected from those ports

Setting	Description
A/V Mute Settings	<p>Adjusts the A/V Mute settings</p> <p>Fade-in: sets the number of seconds for a fade-in transition effect when displaying an image</p> <p>Fade-out: sets the number of seconds for a fade-out transition effect when hiding an image</p> <p>A/V Mute Timer: turns off the projector automatically if A/V Mute is enabled and 2 hours of inactivity has passed</p> <p>A/V Mute Release: select A/V Mute if you want to use only the A/V Mute button to turn off A/V mute, or select Any Button to use any button to turn it off</p>
Advanced	See the next table in this topic
Date & Time	Adjusts the projector's time and date settings
Lens Calibration	Displays information about the lens currently in use

Advanced settings

Setting	Description
BNC Sync Termination	Sets the termination for the signal from the BNC port (set to off unless you need analog termination, such as for switchers)
Remote Control Type	Select Normal to use the remote control that came with the projector, or Simple to use a different Epson projector remote control and disable the remote control that came with the projector
Beep	Controls the beep that sounds when you turn the projector on or off
Indicators	Select Off to turn off projector lights, except warning lights
Instant Off	Select Enabled to place the projector in standby mode after turning it off, or Disabled to place the projector in standby mode approximately 75 seconds after turning it off
Inv Direction Button	Enable this setting if you installed the projector on a ceiling and want to invert the direction of the arrow buttons on the control panel

Setting	Description
HDMI DDC Buffer	If you are projecting using an HDMI extension cable and the image is not displayed correctly, enabling this setting may improve image quality
DVI-D DDC Buffer	If you are projecting using a DVI extension cable and the image is not displayed correctly, enabling this setting may improve image quality
Lens Type	Select the model number for the attached lens when using the following lenses: ELPLS04, ELPLU02, ELPLR04, ELPLW04, ELPLM06, ELPLM07, ELPLL07

Parent topic: [Adjusting the Menu Settings](#)

Projector Network Settings - Network Menu

Settings on the Network menu let you view network information and set up the projector for monitoring and control over a network.

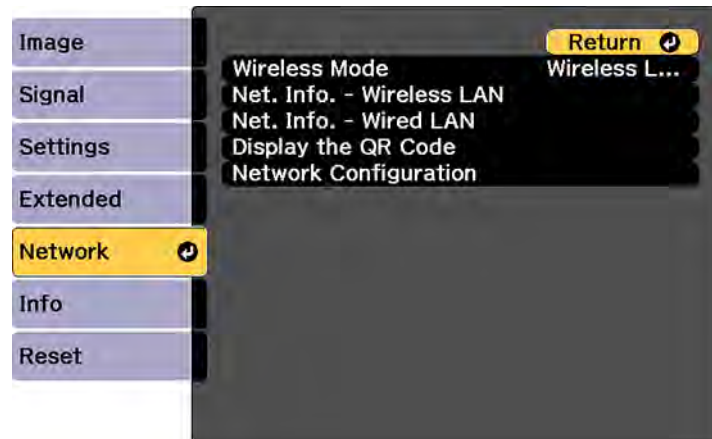

Setting	Options	Description
Wireless Mode	Wireless LAN On Off	Enable or disable wireless communication

Setting	Options	Description
Net. Info - Wireless LAN	Connection mode Wireless LAN Sys. Antenna level Projector Name SSID DHCP IP Address Subnet Mask Gateway Address MAC Address Region Code	Displays wireless network status and details
Net. Info - Wired LAN	Projector Name DHCP IP Address Subnet Mask Gateway Address MAC Address	Displays wired network status and details
Display the QR Code	—	Displays the QR Code
Network Configuration	Accesses additional network menus	Configures your network settings

Parent topic: [Adjusting the Menu Settings](#)

Projector Information Display - Info Menu

You can display information about the projector and input sources by viewing the Info menu. However, you cannot change any settings in the menu.

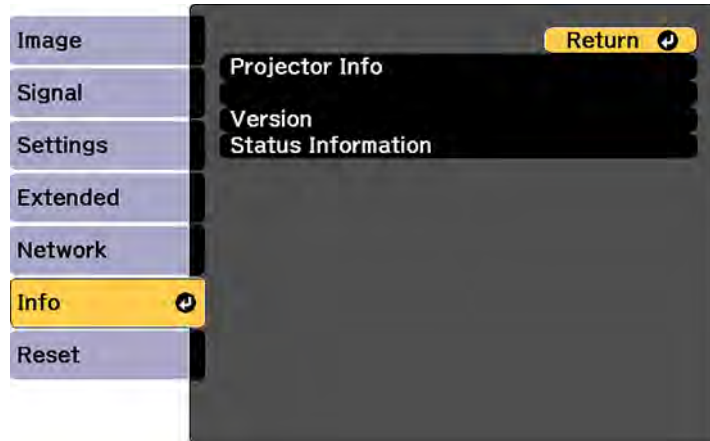

Note: The total operating timer does not register any hours until you have used the projector for at least 10 hours. Available settings depend on the current input source.

Setting	Options	Description
Projector Info	Total Op. Time	Displays the number of hours the projector has been used in its operating life
	Operation Hours	Displays the number of hours the projector has been used since it was turned on
	Source	Displays the name of the port to which the current input source is connected
	Input Signal	Displays the input signal setting of the current input source
	Resolution	Displays the resolution of the current input source
	Refresh Rate	Displays the refresh rate of the current input source
	Sync Info	Displays information that may be needed by a service technician
	Status	Displays information about projector problems that may be needed by a service technician
	Serial Number	Displays the projector's serial number
	Lens Type	Displays the model number of the installed lens
	Event ID	Displays the Event ID number corresponding to a specific projector problem; see the list of Event ID codes
	HDBaseT Signal Level	Displays the image signal information from the HDBaseT port

Setting	Options	Description
Light Source Info	Light Source Hours	Displays the number of operating hours for each of the projector's Light Source Mode settings
	Estimated Remains	If the Constant Brightness setting is enabled, displays the remaining number of hours the projector can maintain constant brightness
Version	Main Video2	Displays the projector's firmware information
Status Information	—	Displays basic status information

[Event ID Code List](#)

Parent topic: [Adjusting the Menu Settings](#)

Event ID Code List

If the **Event ID** option on the Info menu displays a code number, check this list of Event ID codes for the solution to the projector problem associated with the code.

Event ID code	Cause and solution
0432	Turn the projector off and then on again.
0435	
0434	Unstable network communication. Check the network communication status, wait a few moments, and try connecting to the network again.
0482	
0484	
0485	
0433	Cannot display the transferred images. Restart the network software.
0481	Communication with computer was disconnected. Restart the network software.
0483	The network software quit unexpectedly. Check the network communication status, then turn the projector off and then on again.
04FE	

Event ID code	Cause and solution
0479 04FF	A projector system error has occurred. Turn the projector off and then on again.
0891	Cannot find an access point with the same SSID. Set your computer, access point, and projector to the same SSID.
0892	The WPA/WPA2 authentication type does not match. Make sure the wireless network security settings are correct.
0893	The TKIP/AES encryption type does not match. Make sure the wireless network security settings are correct.
0894	Communication with unauthorized access point was disconnected. Contact your network administrator.
0898	Failed to acquire DHCP. Make sure the DHCP server is operating correctly. If you are not using DHCP, turn off the DHCP setting in the Network menus.
0899	Communication error. Turn the projector off and then on again.

Parent topic: [Projector Information Display - Info Menu](#)

Projector Reset Options - Reset Menu

You can reset most of the projector settings to their default values using the **Reset All Config** option on the Reset menu.

You can also reset the saved names and settings in the Save Memory list using the **Reset All Memories** option.

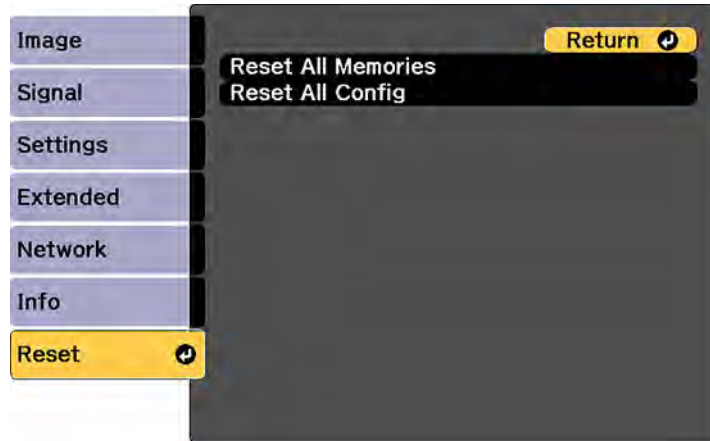

You cannot reset the following settings using the **Reset All Config** option:

- Input Signal
- User's Logo
- Language
- Network menu items
- Date & Time
- Panel Alignment
- Color Uniformity
- Memory
- Color Matching
- Lens Calibration
- Color Calibration
- Projector Grouping
- Screen Matching

Parent topic: [Adjusting the Menu Settings](#)

Maintaining and Transporting the Projector

Follow the instructions in these sections to maintain your projector and transport it from place to place.

[Projector Maintenance](#)

[Transporting the Projector](#)

Projector Maintenance

Your projector needs little maintenance to keep working at its best.

You may need to clean the lens periodically, and clean the air filter and air vents to prevent the projector from overheating due to blocked ventilation.

The only parts you should replace are the air filter and remote control batteries. If any other part needs replacing, contact Epson or an authorized Epson servicer.

This projector uses a sealed laser light source which does not need servicing and cannot be replaced.

Warning: Before cleaning any part of the projector, turn it off and unplug the power cord. Never open any cover on the projector, except as specifically explained in this manual. Dangerous electrical voltages in the projector can injure you severely.

Warning: Do not try to service this product yourself, except as specifically explained in this manual. Refer all other servicing to qualified servicers.

[Cleaning the Lens](#)

[Cleaning the Projector Case](#)

[Air Filter and Vent Maintenance](#)

[Replacing the Remote Control Batteries](#)

Parent topic: [Maintaining and Transporting the Projector](#)

Cleaning the Lens

Clean the projector's lens periodically, or whenever you notice dust or smudges on the surface.

- To remove dust or smudges, gently wipe the lens with lens-cleaning paper.

- To remove stubborn smudges, moisten a soft, lint-free cloth with lens cleaner and gently wipe the lens. Do not spray any liquid directly on the lens.

Warning: Do not use a lens cleaner that contains flammable gas. The high heat generated by the projector may cause a fire.

Caution: Do not use glass cleaner or any harsh materials to clean the lens and do not subject the lens to any impacts; you may damage it. Do not use canned air, or the gases may leave a residue. Avoid touching the lens with your bare hands to prevent fingerprints on or damage to the lens surface.

Parent topic: [Projector Maintenance](#)

Cleaning the Projector Case

Before cleaning the projector case, turn off the projector and unplug the power cord.

- To remove dust or dirt, use a soft, dry, lint-free cloth.
- To remove stubborn dirt, use a soft cloth moistened with water and mild soap. Do not spray liquid directly on the projector.

Caution: Do not use wax, alcohol, benzene, paint thinner, or other chemicals to clean the projector case. These can damage the case. Do not use canned air, or the gases may leave a residue.

Parent topic: [Projector Maintenance](#)

Air Filter and Vent Maintenance

Regular filter maintenance is important to maintaining your projector. Your Epson projector is designed with an easily accessible, user-replaceable filter to protect your projector and make regular maintenance simple. Filter maintenance intervals will depend on the environment.

If regular maintenance is not performed, your Epson projector will notify you when the temperature inside the projector has reached a high level. Do not wait until this warning appears to maintain your projector filter as prolonged exposure to high temperatures may reduce the life of your projector or laser.

Damage due to the failure to properly maintain the projector or its filter may not be covered by the projector's Limited Warranty.

[Cleaning the Air Filter](#)

[Replacing the Air Filter](#)

Parent topic: [Projector Maintenance](#)

Related references

[Projector Light Status](#)

Cleaning the Air Filter

You need to clean the projector's air filter in the following situations:

- The filter or vents get dusty.
 - You see a message telling you to clean it.
 - The projector's Filter light flashes orange.
1. Turn off the projector, wait for the projector to beep, and unplug the power cord.
 2. Slide the air filter cover latch and open the air filter cover.

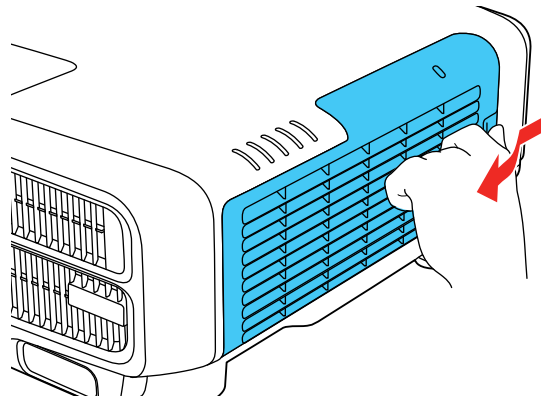

3. Pull the air filter out of the projector.

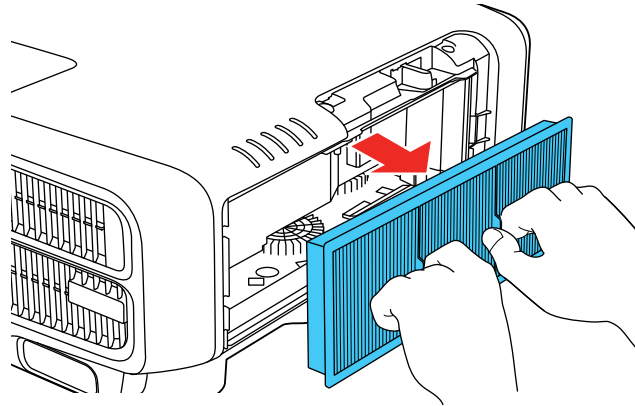

4. Tap each side of the air filter 4 to 5 times to shake off any excess dust.

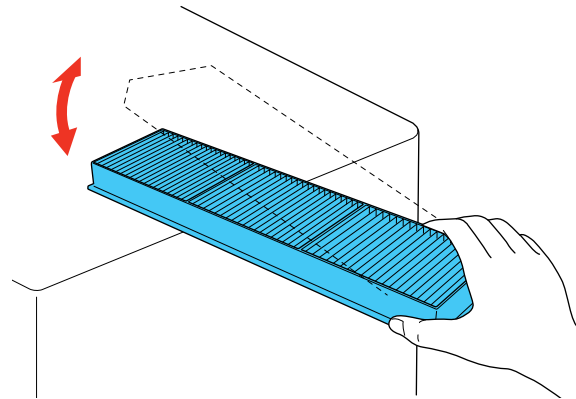

Caution: Do not use excessive force when tapping the air filter, or it may crack and become unusable. Do not rinse the air filter in water, or use any detergent or solvent to clean it. Do not use canned air; the gases may leave a residue, or push dust and debris into the projector's optics or other sensitive areas.

5. Vacuum the front of the air filter (the side with the tabs) to remove any remaining dust.

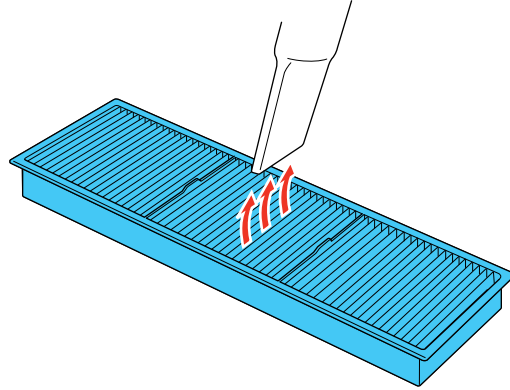

Note: If dust is difficult to remove or the air filter is damaged, replace the air filter.

6. Place the air filter back in the projector as shown and push gently until it clicks into place.

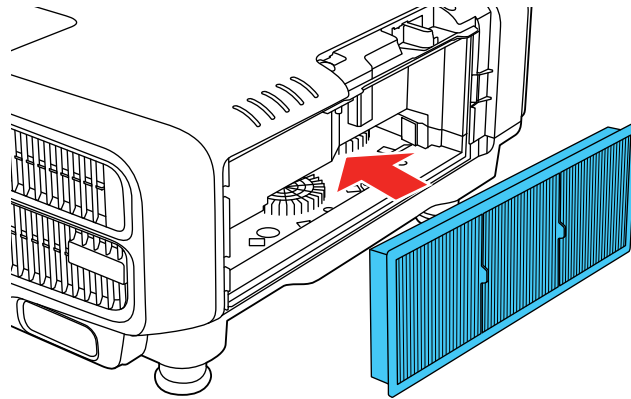

7. Attach the air filter cover as shown, and press it gently until it clicks into place.

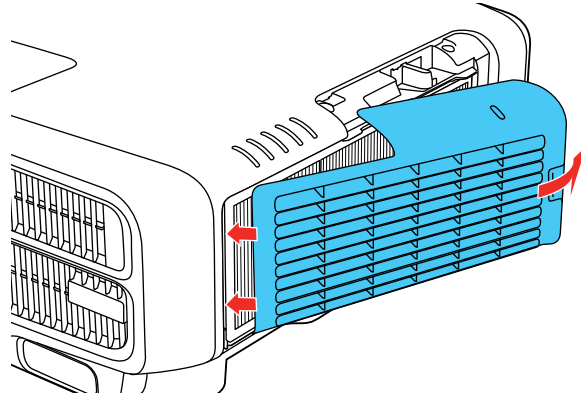

Parent topic: [Air Filter and Vent Maintenance](#)

Related references

[Projector Light Status](#)

Replacing the Air Filter

You need to replace the air filter in the following situations:

- After cleaning the air filter, you see a message telling you to clean or replace it
- The air filter is torn or damaged

You can replace the air filter while the projector is mounted to the ceiling or placed on a table.

1. Turn off the projector, wait for the projector to beep, and unplug the power cord.

2. Slide the air filter cover latch and open the air filter cover.

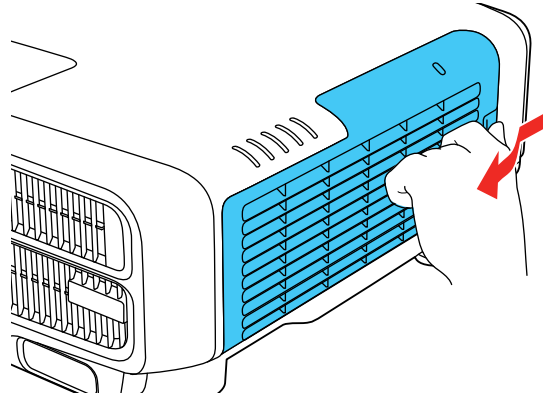

3. Pull the air filter out of the projector.

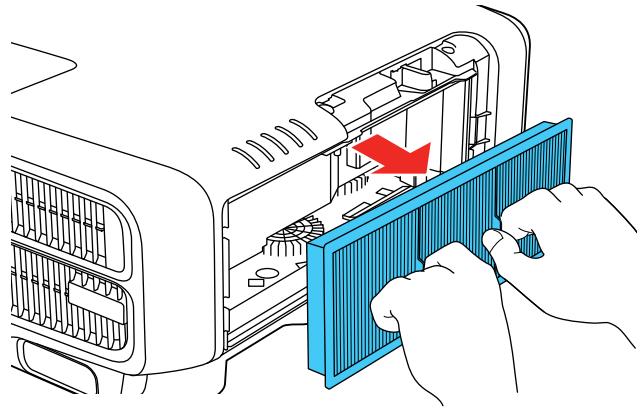

Note: Air filters contain polypropylene. Dispose of used air filters according to local regulations.

4. Place the new air filter in the projector as shown and push gently until it clicks into place.

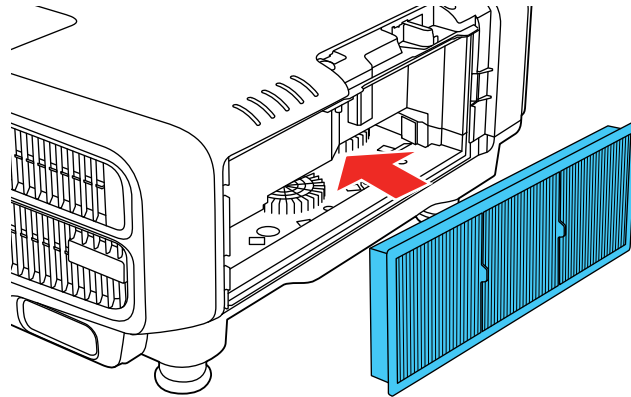

5. Attach the air filter cover as shown, and press it gently until it clicks into place.

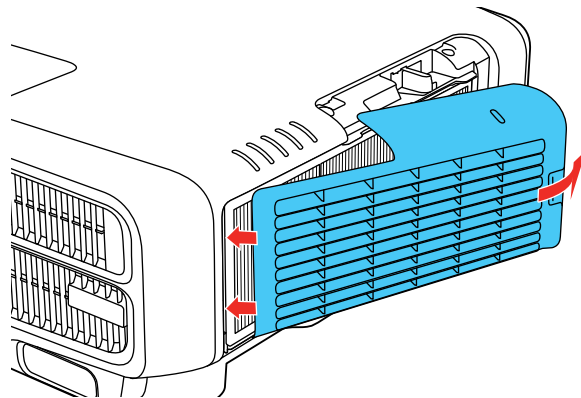

Parent topic: [Air Filter and Vent Maintenance](#)

Related references

[Projector Light Status](#)

[Optional Equipment and Replacement Parts](#)

Replacing the Remote Control Batteries

The remote control uses two AA manganese or alkaline batteries. Replace the batteries as soon as they run out.

Caution: Use only the type of batteries specified in this manual. Do not install batteries of different types, or mix new and old batteries.

1. Remove the battery cover as shown.

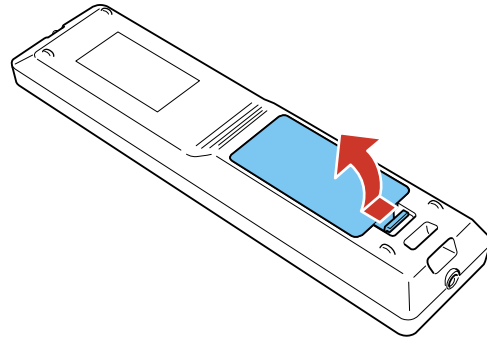

2. Remove the old batteries.

Warning: If the battery fluid has leaked, wipe it away with a soft cloth and avoid getting the fluid on your hands. If it gets on your hands, wash them immediately to avoid injury.

3. Insert the batteries with the + and – ends facing as shown.

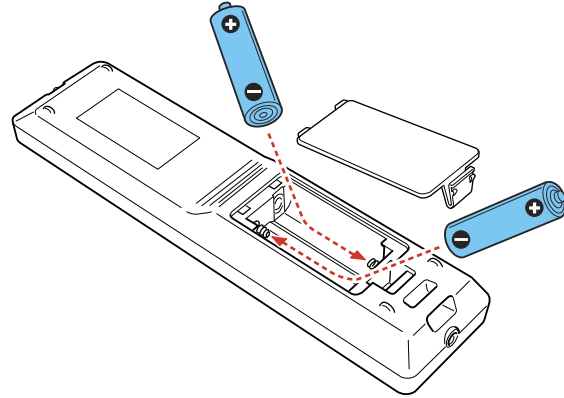

4. Replace the battery cover and press it down until it clicks into place.

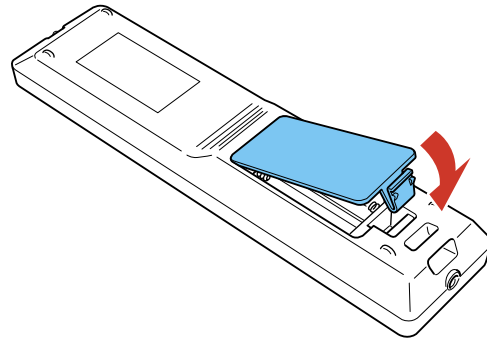

Warning: Dispose of used batteries according to local regulations. Do not expose batteries to heat or flame. Keep batteries out of the reach of children; they are choking hazards and are very dangerous if swallowed.

Parent topic: [Projector Maintenance](#)

Transporting the Projector

The projector contains precision parts, some of which are glass. Follow the guidelines here to transport, ship, or store the projector safely.

Caution: Use two or more people to unpack or lift the projector.

1. Remove any equipment connected to the projector.
2. Do one of the following:
 - If you are using the standard zoom lens, keep it installed on the projector. Move the lens to the home position and attach the protective lens pad that was included with the projector.
 - If you are using an optional lens, remove it from the projector.
 - If the projector did not come with a lens, attach the cover that was included with the projector to the lens mount.
3. Do one of the following:
 - When transporting the projector a long distance or as checked luggage, pack it in a firm box with cushioning around it and mark the box "Fragile."
 - When shipping the projector for repairs, place it in its original packing materials, if possible, or use equivalent materials with cushioning around the projector. Mark the box "Fragile."

Note: Epson shall not be liable for any damages incurred during transportation.

Parent topic: [Maintaining and Transporting the Projector](#)

Related tasks

[Attaching a Lens](#)

[Removing a Lens](#)

[Adjusting the Image Position Using Lens Shift](#)

Solving Problems

Check the solutions in these sections if you have any problems using the projector.

[Projection Problem Tips](#)

[Projector Light Status](#)

[Viewing the Status Display](#)

[Using the Projector Help Displays](#)

[Solving Image or Sound Problems](#)

[Solving Projector or Remote Control Operation Problems](#)

[Solving Network Problems](#)

[Where to Get Help](#)

Projection Problem Tips

If the projector is not working properly, try turning it off and unplugging it. Then plug it back in and turn it on.

If this does not solve the problem, check the following:

- The lights on the projector may indicate what the problem is.
- The Help option on the Home screen can display information about common problems, if the projector is operating.
- The solutions in this manual can help you solve many problems.

If none of these solutions help, you can contact Epson for technical support.

Parent topic: [Solving Problems](#)

Projector Light Status

The lights on the projector indicate the projector status and let you know when a problem occurs. Check the status and color of the lights and look for a solution in the table here.

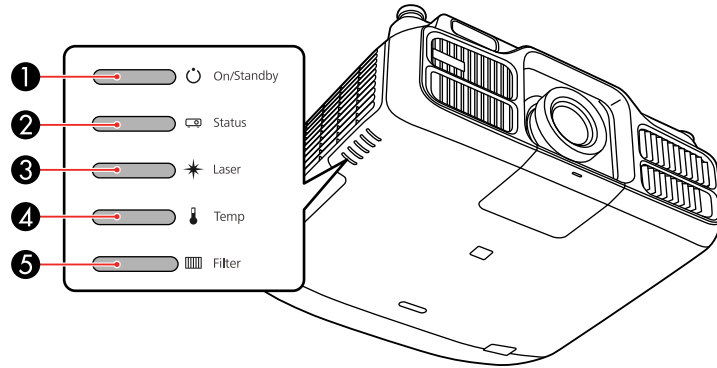

- 1 On/Standby (power) light
- 2 Status light
- 3 Laser light
- 4 Temp (temperature) light
- 5 Filter light

On/Standby (power) light	Status light	Laser light	Temp light	Filter light	Status and solution
Blue	Blue	Varies	Off	Off	Normal operation.
Blue	Blue	Flashing blue	Off	Off	A/V Mute is on.
Blue	Flashing blue	Varies	Off	Off	Warming up. Wait for an image to appear.
Blue	Off	Off	Off	Off	Standby or network monitoring and control (when Standby Mode is set to Communication On).

On/Standby (power) light	Status light	Laser light	Temp light	Filter light	Status and solution
Flashing blue	Off	Off	Off	Off	Preparing network monitoring. (Wait for the light to remain orange before unplugging the projector.)
Blue	Flashing blue	Off	Off	Off	Cooling down. All buttons are disabled.
Flashing blue	Varies	Varies	Flashing orange	Varies	High temperature warning. If the temperature gets too high, projection will automatically stop. <ul style="list-style-type: none"> • Make sure that the vents and air filter are not clogged with dust or obstructed by nearby objects. • Clean or replace the air filter.
Off	Flashing blue	Orange	Orange	Off	Lens Shift error. Turn off the projector, unplug it from the electrical outlet, and contact Epson for help
Off	Flashing blue	Flashing orange	Off	Off	Internal error. Turn off the projector, unplug it from the electrical outlet, and contact Epson for help.

On/Standby (power) light	Status light	Laser light	Temp light	Filter light	Status and solution
Off	Flashing blue	Off	Orange	Off	<p>Projector is too hot (overheating) and projection stops. Leave it for about five minutes to cool down.</p> <ul style="list-style-type: none"> • Make sure that the vents and air filter are not clogged with dust or obstructed by nearby objects. • Clean or replace the air filter. • Make sure the environmental temperature is not too hot. • If operating the projector at high altitude, turn on High Altitude Mode. • If the problem persists, unplug the projector and contact Epson for help.
Off	Flashing blue	Orange	Off	Off	<p>Laser has a problem.</p> <ul style="list-style-type: none"> • Make sure that the vents and air filter are not clogged with dust or obstructed by nearby objects. • Clean or replace the air filter. • If the problem persists, unplug the projector and contact Epson for help.
Varies	Varies	Varies	Varies	Flashing orange	It is time to clean the air filter.

On/Standby (power) light	Status light	Laser light	Temp light	Filter light	Status and solution
Off	Flashing blue	Off	Off	Orange	Low air flow through the projector. <ul style="list-style-type: none"> • Make sure that the vents and air filter are not clogged with dust or obstructed by nearby objects. • Clean or replace the air filter. • If the problem persists, unplug the projector and contact Epson for help.
Flashing blue	Varies	Varies	Varies	Orange	Low air flow through the air filter. <ul style="list-style-type: none"> • Make sure that the vents and air filter are not clogged with dust or obstructed by nearby objects. • Clean or replace the air filter. • If the problem persists, unplug the projector and contact Epson for help.
Off	Flashing blue	Off	Flashing orange	Off	A fan or sensor has a problem. Turn the projector off, unplug it, and contact Epson for help.
Flashing blue	Varies	Flashing orange	Varies	Varies	Laser has a problem. Turn the projector off, unplug it, and contact Epson for help.
Flashing blue	Varies	Flashing orange	Varies	Varies	An unsupported lens is attached (Pro L1500U/L1505U). Make sure your lens is supported.

Note: If the lights display a pattern not listed in the table above, turn the projector off, unplug it, and contact Epson for help.

Parent topic: [Solving Problems](#)

Related concepts

[Air Filter and Vent Maintenance](#)

Related references

[Projector Setup Settings - Extended Menu](#)

[Optional Equipment and Replacement Parts](#)

Related tasks

[Stopping Video Action Temporarily](#)

Viewing the Status Display

You can monitor the projector's status and view error information from the status display.

1. Turn on the projector.
2. Press the **i** button on the remote control or the right arrow button on the control panel.

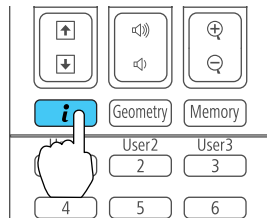

3. Select **Status Information** and press **Enter**.

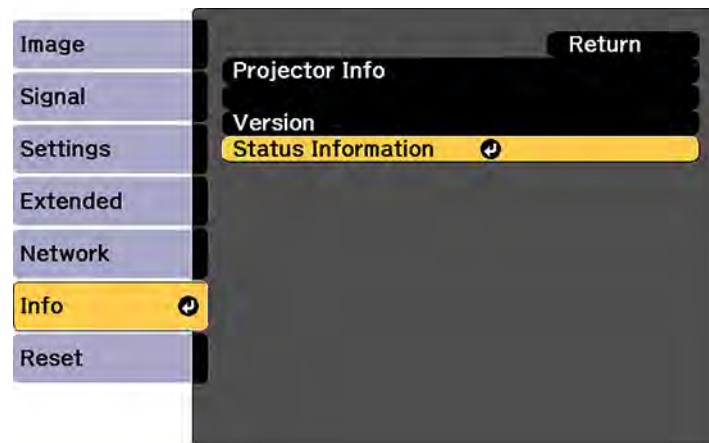

- Press the left or right arrow buttons to view different categories of information.

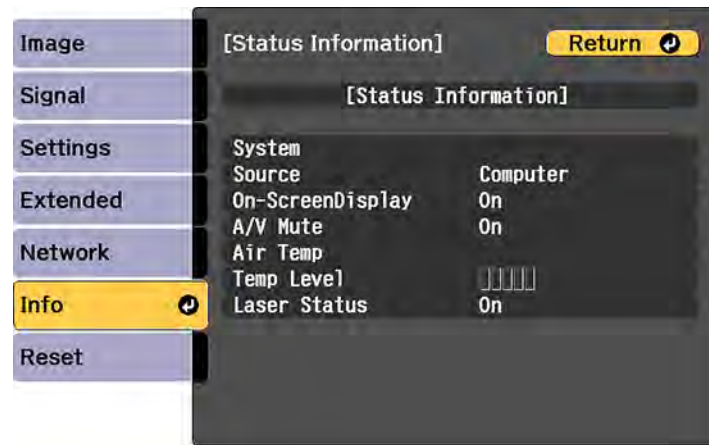

- **Status Information:** The projector's operating status
- **Source:** Input signal information
- **Signal Information:** Input digital signal information
- **Network Wired:** Wired LAN settings
- **Network Wireless:** Wireless LAN settings
- **Maintenance:** Operating time for the projector and light source

[Projector Status Display Messages](#)

Parent topic: [Solving Problems](#)

Projector Status Display Messages

Categories on the status display screens let you view information about the projector and its operation.

Status Information category

Information	Description
System	See the System status information table at the end of this topic
Source	Displays the source currently being used

Information	Description
On-Screen Display	Displays the settings for on-screen displays . When turned off, menus or messages are not displayed on the projected images
A/V Mute	Displays the A/V Mute status
Air Temp	Display the environmental temperature
Temp Level	
Laser Status	Display the operating status of the light source

Source category

Information	Description
Source	Displays the source currently being used
Resolution	Displays the resolution of the current input signal
Video Signal	Displays the current input video signal
Color Space	Displays the color space of the current input signal
H-Frequency	Displays the horizontal frequency of the current input signal
V-Frequency	Displays the vertical frequency of the current input signal
Sync Polarity	Displays the sync polarity
Sync Mode	Displays the sync type
Detected Mode	Displays the detected mode of the current input signal
Video Level	Displays the video level of the projector

Signal Information category

Information	Description
5V Detect	Displays the detection results of 5V signals

Information	Description
TMDS Clock	Displays the TMDS frequency of the current input signal
TMDS H-Frequency	Displays the horizontal frequency of the current input signal
TMDS V-Frequency	Displays the vertical frequency of the current input signal
DetChg 5CFHMP123	Displays the factors of signal changes
Stable Time	Displays the amount of operating time since the input source was determined
HDCP Status	Displays the HDCP status
HDCP Ver	Displays the HDCP version
AVI Info VIC	Displays the VIC information (AVI) of the current input signal
AVI InfoChecksum	Displays the checksum result for AVI
Signal Mode	Displays the signal mode
Pixel Encoding	Displays the color space information (AVI) of the current input signal
HDBaseT Quality	Displays the image signal information from the HDBaseT port

Network Wired category

Information	Description
Projector Name	Displays the name used to identify the projector when connected to a network
Connection Mode	Displays the connection path for the LAN
DHCP	Displays the DHCP display settings
IP Display	Displays the IP address display settings
IP Address	Displays the IP address
MAC Address	Displays the MAC address

Network Wireless category

Information	Description
Projector Name	Displays the name used to identify the projector when connected to a network
Connection Mode	Displays the connection mode to use when connecting the projector and a computer over a wireless LAN
SSID Display	Displays the SSID display settings
IP Display	Displays the IP address display settings
SSID	Displays the SSID
IP Address	Displays the IP address
DHCP	Displays the DHCP settings
MAC Address	Displays the MAC address
Security	Displays the security settings
Antenna Level	Displays the reception status for Wi-Fi

Maintenance category

Information	Description
Operation Time	Displays the projector's total operation time
Laser Op. Time	Displays the laser operating time for each Light Source Mode setting

Version category

Information	Description
Serial No.	Displays the projector's serial number

Information	Description
Main	Display the projector's firmware version information
Video2	
Sub	
Sub2	
HDBaseT	

System status information

Status	Description
OK	The projector is in normal operating mode
Warm-up	The projector is warming up
Standby	The projector is in standby mode
Cool Down	The projector is cooling down
Temp Error	A high temperature error occurred
Fan Error	A fan error occurred
Sensor Error	A sensor error occurred
Power Error	A power error occurred
Internal Error	An internal error occurred
Airflow Error	A filter airflow error occurred
Temp Warning	A high temperature warning occurred
Internal Warning	A warning regarding the internal system occurred
Airflow Decline	A low airflow error occurred
Power Warning	A power warning occurred
Clean Filter	An air filter notice occurred; clean the air filter
Lens Error	A lens error has occurred
Laser Error	A laser error has occurred
Laser Warning	A laser warning has occurred

Parent topic: [Viewing the Status Display](#)

Using the Projector Help Displays

You can display information to help you solve common problems using the projector's Help system.

1. Turn on the projector.
2. Press the **Home** button on the remote control.
3. Use the arrow buttons to select **Help**.
4. Press **Enter**.

You see the Help menu.

5. Use the up and down arrow buttons to highlight the problem you want to solve.
6. Press **Enter** to view the solutions.
7. When you are finished, do one of the following:
 - To select another problem to solve, press **Esc**.
 - To exit the help system, press **Home**.

Parent topic: [Solving Problems](#)

Solving Image or Sound Problems

Check the solutions in these sections if you have any problems with projected images or sound.

[Solutions When No Image Appears](#)

[Solutions When "No Signal" Message Appears](#)

[Solutions When "Not Supported" Message Appears](#)

[Solutions When Only a Partial Image Appears](#)

[Solutions When the Image is Not Rectangular](#)

[Solutions When the Image Contains Noise or Static](#)

[Solutions When the Image is Fuzzy or Blurry](#)

[Solutions When the Image Brightness or Colors are Incorrect](#)

[Solutions to Sound Problems](#)

Parent topic: [Solving Problems](#)

Solutions When No Image Appears

If no image appears, try the following solutions:

- Make sure the lens cap is off.
- Press the **A/V Mute** button on the remote control to see if the image was temporarily turned off.
- Make sure all necessary cables are securely connected and the power is on for the projector and connected video sources.
- Press the projector's power button to wake it from standby or sleep mode. Also see if your connected computer is in sleep mode or displaying a blank screen saver.
- Press the **Menu** button. If the projector menu is able to display, there may be a problem with the connected video source, cable connection, or port.
- Check the settings on the Signal menu to make sure they are correct for the current video source.
- Adjust the **Brightness Settings**.
- Check the **Display** setting to make sure **Messages** is set to **On**.
- If the projector does not respond when you press the control panel buttons, the buttons may be locked. Unlock the buttons.
- For images projected with Windows Media Center, reduce the screen size from full screen mode.
- For images projected from applications using Windows DirectX, turn off DirectX functions.
- If the other solutions do not solve the problem, reset all of the projector settings using the options on the **Reset** menu.

Parent topic: [Solving Image or Sound Problems](#)

Related concepts

[Projector Connections](#)

Related references

[Input Signal Settings - Signal Menu](#)

[Projector Setup Settings - Extended Menu](#)

Related tasks

[Adjusting the Brightness](#)

[Unlocking the Projector's Buttons](#)

Solutions When "No Signal" Message Appears

If the "No Signal" message appears, try the following solutions:

- Press the **Source Search** or **Search** button and wait a few seconds for an image to appear.
- Turn on the connected computer or video source, and press its play button to begin your presentation, if necessary.
- Check the connection from the projector to your video sources.
- If you are projecting from a laptop computer, make sure it is set up to display on an external monitor.
- If necessary, turn the projector and the connected computer or video source off and then on again.
- If the other solutions do not solve the problem, reset all of the projector settings using the options on the **Reset** menu.

[Displaying From a PC Laptop](#)

[Displaying From a Mac Laptop](#)

Parent topic: [Solving Image or Sound Problems](#)

Related concepts

[Projector Connections](#)

Displaying From a PC Laptop

If you see the "No Signal" message when you display from a PC laptop, you need to set up the laptop to display on an external monitor.

1. Hold down the laptop's **Fn** key and press the key labeled with a monitor icon or **CRT/LCD**. (See your laptop manual for details.) Wait a few seconds for an image to appear.
2. To display on both the laptop's monitor and the projector, try pressing the same keys again.
3. If the same image is not displayed by the laptop and projector, check the Windows **Display** utility to make sure the external monitor port is enabled and extended desktop mode is disabled. (See your computer or Windows manual for instructions.)
4. If necessary, check your video card settings and set the multiple display option to **Mirror** or **Duplicate**.

Parent topic: [Solutions When "No Signal" Message Appears](#)

Displaying From a Mac Laptop

If you see the "No Signal" message when you display from a Mac laptop, you need to set up the laptop for mirrored display. (See your laptop manual for details.)

1. Open the **System Preferences** utility and select **Displays**.

2. Click the **Arrangement** tab.
3. Select the **Mirror Displays** checkbox.

Parent topic: [Solutions When "No Signal" Message Appears](#)

Solutions When "Not Supported" Message Appears

If the "Not Supported" message appears, try the following solutions:

- Make sure the correct input signal is selected on the Signal menu.
- Make sure the computer's display resolution does not exceed the projector's resolution and frequency limit. If necessary, select a different display resolution for your computer. (See your computer manual for details.)
- As a test, try setting the computer's display resolution to the lowest possible setting, and then gradually increase it as necessary.

Parent topic: [Solving Image or Sound Problems](#)

Related references

[Input Signal Settings - Signal Menu](#)

[Supported Video Display Formats](#)

Solutions When Only a Partial Image Appears

If only a partial computer image appears, try the following solutions:

- Make sure you selected the correct **Screen Type** setting for the screen being used.
- Make sure the **Scale** setting in the Extended menu is turned off.
- Try adjusting the image position using the **Position** menu setting.
- Try adjusting the image position using the **Screen Position** menu setting.
- Press the **Aspect** button on the remote control to select a different image aspect ratio.
- If you zoomed into or out of the image using the **E-Zoom** buttons, press the **Esc** button until the projector returns to a full display.
- Check the cables connecting the computer or video source to the projector. Try connecting different cables.
- Check your computer display settings to disable dual display and set the resolution within the projector's limits. (See your computer manual for details.)
- Check the resolution assigned to your presentation files to see if they are created for a different resolution than you are projecting in. (See your software help for details.)

Parent topic: [Solving Image or Sound Problems](#)

Related concepts

[Projector Connections](#)

Related references

[Projector Setup Settings - Extended Menu](#)

[Input Signal Settings - Signal Menu](#)

[Supported Video Display Formats](#)

Related tasks

[Setting the Screen Type](#)

[Adjusting the Image Position Using Screen Position](#)

Solutions When the Image is Not Rectangular

If the projected image is not evenly rectangular, try the following solutions:

- Place the projector directly in front of the center of the screen, facing it squarely, if possible.
- Adjust the image shape using the **Geometry Correction** menu settings.

Parent topic: [Solving Image or Sound Problems](#)

Related references

[Projector Feature Settings - Settings Menu](#)

Solutions When the Image Contains Noise or Static

If the projected image seems to contain electronic interference (noise) or static, try the following solutions:

- Check the cables connecting your computer or video source to the projector. They should be:
 - Separated from the power cord to prevent interference
 - Securely connected at both ends
 - Not connected to an extension cable
 - No longer than 10 feet (3 m) for VGA/computer cables or 24 feet (7.3 m) for HDMI cables
- Check the settings on the projector's Signal menu to make sure they match the video source. If available for your video source, adjust the **Deinterlacing** and **Noise Reduction** settings.
- Select a computer video resolution and refresh rate that are compatible with the projector.

- If you are projecting from a computer, press the **Auto** button on the remote control to automatically adjust the tracking and sync. If the problem remains, display a uniformly patterned image on the screen and manually adjust the **Tracking** and **Sync** settings.
- If you adjusted the image shape using the projector controls, try decreasing the **Sharpness** setting to improve image quality.
- If you connected an extension power cable, try projecting without it to see if it caused interference in the signal.
- Try a different cable.
- Try turning off **Frame Interpolation**, or turn on **Image Enhancement** in the Image menu.

Parent topic: [Solving Image or Sound Problems](#)

Related references

[Image Quality Settings - Image Menu](#)

[Input Signal Settings - Signal Menu](#)

[Supported Video Display Formats](#)

Solutions When the Image is Fuzzy or Blurry

If the projected image is fuzzy or blurry, try the following solutions:

- Adjust the image focus.
- Clean the projector lens.

Note: To avoid condensation on the lens after bringing the projector in from a cold environment, let the projector warm up to room temperature before using it.

- Try connecting the projector to the highest quality connection available on your input source. For example, connect to an HDMI port or component video ports for a better quality input signal.
- Position the projector close enough to the screen.
- Position the projector so the keystone adjustment angle is not so wide that it distorts the image.
- Adjust the **Sharpness** setting to improve image quality.
- If you are projecting from a computer, press the **Auto** button on the remote control to automatically adjust the tracking and sync. If any bands or overall blurriness remain, display a uniformly patterned image on the screen and manually adjust the **Tracking** and **Sync** settings.
- If you are projecting from a computer, try using a lower resolution or try to match the projector's native resolution.

Parent topic: [Solving Image or Sound Problems](#)

Related concepts

[Projector Connections](#)

Related references

[Projector Setup and Installation Options](#)

[Image Quality Settings - Image Menu](#)

[General Projector Specifications](#)

[Supported Video Display Formats](#)

Related tasks

[Focusing the Image Using the Focus Button](#)

[Cleaning the Lens](#)

Solutions When the Image Brightness or Colors are Incorrect

If the projected image is too dark or light, or the colors are incorrect, try the following solutions:

- Press the **Color Mode** button on the remote control to try different color modes for the image and environment.
- Check your video source settings.
- Adjust the available settings on the Image menu for the current input source, such as **Brightness**, **Contrast**, **Tint**, **Advanced**, and **Color Saturation**.
- Make sure you selected the correct **Input Signal** or **Video Signal** setting on the Signal menu, if available for your image source.
- Make sure all the cables are securely connected to the projector and your video device. If you connected long cables, try connecting shorter cables.
- Make sure the **Brightness Settings** in the Settings menu is set correctly.
- Position the projector close enough to the screen.

Parent topic: [Solving Image or Sound Problems](#)

Related references

[Image Quality Settings - Image Menu](#)

[Input Signal Settings - Signal Menu](#)

[Projector Feature Settings - Settings Menu](#)

[Projection Distance](#)

Solutions to Sound Problems

If there is no sound when you expect it or the volume is too low or high, try the following solutions:

- Adjust the projector's volume settings.
- Press the **A/V Mute** button on the remote control to resume video and audio if they were temporarily stopped.
- Press the **Source Search** or **Search** button to switch to the correct input source, if necessary.
- Check your computer or video source to make sure the volume is turned up and the audio output is set for the correct source.
- Check the audio cable connections between the projector and your video source.
- If you do not hear sound from an HDMI source, set the connected device to PCM output.
- Make sure any connected audio cables are labeled "No Resistance".
- If you are using a Mac and you do not hear sound from an HDMI source, make sure your Mac supports audio through the HDMI port. If not, you need to connect an audio cable.
- If you want to use a connected audio source when the projector is off, set the **Standby Mode** option to **Communication On** and make sure the **A/V Settings** options are set correctly.
- You must connect external speakers to the projector to hear sound (Pro L1405U/L1500U/L1505U).
- Make sure the **Audio Settings** option is set to the correct audio port for your video device.
- If you connected an audio device to the projector's **Audio Out** port, the internal speaker is disabled. However, you can still control the volume level via the remote control.
- If you turn the projector on immediately after turning it off, the cooling fans may run at high speed momentarily and cause an unexpected noise. This is normal.

Parent topic: [Solving Image or Sound Problems](#)

Related references

[Projector Setup Settings - Extended Menu](#)

Related tasks

[Controlling the Volume with the Volume Buttons](#)

[Connecting to a Video Source for Sound](#)

[Connecting to a Computer for Sound](#)

[Connecting to External Speakers](#)

Solving Projector or Remote Control Operation Problems

Check the solutions in these sections if you have problems operating the projector or remote control.

[Solutions to Projector Power or Shut-Off Problems](#)

[Solutions to Problems with the Remote Control](#)

[Solutions to Password Problems](#)

Parent topic: [Solving Problems](#)

Solutions to Projector Power or Shut-Off Problems

If the projector does not come on when you press the power button or it shuts off unexpectedly, try the following solutions:

- Make sure the power cord is securely connected to the projector and to a working electrical outlet.
- The projector's buttons may be locked for security. Unlock the buttons or use the remote control to turn on the projector.
- If the projector's laser shuts off unexpectedly, it may have entered standby mode after a period of inactivity. Press the power button to wake the projector and adjust the Sleep Mode Timer setting to change the sleep interval.
- If the projector's laser shuts off, the Status light is flashing blue, and the Temp light is orange, the projector has overheated and shut off. Check the solutions for this light status.
- If the power button on the remote control does not turn on the projector, check its batteries and make sure the **Remote Receiver** setting is turned on in the projector's menu, if available.
- The power cord may be defective. Try another power cord. If that doesn't work, disconnect the cord and contact Epson.

Parent topic: [Solving Projector or Remote Control Operation Problems](#)

Related references

[Projector Setup Settings - Extended Menu](#)

[Projector Feature Settings - Settings Menu](#)

[Projector Light Status](#)

Related tasks

[Unlocking the Projector's Buttons](#)

Solutions to Problems with the Remote Control

If the projector does not respond to remote control commands, try the following solutions:

- Check that the remote control batteries are installed correctly and have power. If necessary, replace the batteries.
- Make sure you are operating the remote control within the reception angle and range of the projector.
- Make sure the projector is not warming up or shutting down.
- Check to see if a button on the remote control is stuck down, causing it to enter sleep mode. Release the button to wake the remote control up.
- Strong fluorescent lighting, direct sunlight, or infrared device signals may be interfering with the projector's remote receivers. Dim the lights or move the projector away from the sun or interfering equipment.
- Make sure the optional remote control cable set is not attached to the projector's **Remote** port. If you leave the cable connected to the port, the remote control cannot control the projector.
- If available, turn off one of the remote receivers in the projector's menu system, or check if all the remote receivers were turned off.
- If you assigned an ID number to the remote control to operate multiple projectors, you may need to check or change the ID setting (feature not available with all projectors).
- Make sure the **Remote Control Type** setting in the Extended menu is set to **Normal** if you are using the remote control that came with the projector.
- Make sure the **Control Communications** or **Extron XTP** setting in the Extended menu is set to **Off** if you are using the optional remote control cable set.
- If you lose the remote control, you can purchase another from an authorized Epson reseller.

Parent topic: [Solving Projector or Remote Control Operation Problems](#)

Related concepts

[Projector Identification System for Multiple Projector Control](#)

Related references

[Remote Control Operation](#)

[Projector Feature Settings - Settings Menu](#)

[Projector Setup Settings - Extended Menu](#)

Related tasks

[Replacing the Remote Control Batteries](#)

Solutions to Password Problems

If you cannot enter or remember a password, try the following solutions:

- You may have turned on password protection without first setting a password. Try entering **0000** using the remote control.
- If you have entered an incorrect password too many times and see a message displaying a request code, write down the code and contact Epson. Do not attempt to enter the password again. Provide the request code and proof of ownership for assistance in unlocking the projector.
- If you set a Web Control password and forgot the user ID or password, try entering the following:
 - User ID: **EPSONWEB**
 - Default password: **admin**
- If you set a Remote password (in Epson Web Control) and forgot the user ID or password, try entering the following:
 - User ID: **EPSONREMOTE**
 - Default password: **guest**
- If you lose the remote control, you cannot enter a password. Order a new one from Epson.

Parent topic: [Solving Projector or Remote Control Operation Problems](#)

Related concepts

[Password Security Types](#)

Solving Network Problems

Check the solutions in these sections if you have problems using the projector on a network.

[Solutions When You Cannot Access the Projector Through the Web](#)

[Solutions When Network Alert E-Mails are Not Received](#)

Parent topic: [Solving Problems](#)

Solutions When You Cannot Access the Projector Through the Web

If you are unable to access the projector through a web browser, make sure you are using the correct ID and password, which are case sensitive.

- For the user ID, enter **EPSONWEB**. (You cannot change the user ID.)
- For the password, enter the password set in the projector's Network menu. The default password is **admin**.

- Make sure you have access to the network the projector is on.

Note: The user ID and password are case sensitive.

Parent topic: [Solving Network Problems](#)

Related concepts

[Password Security Types](#)

Related tasks

[Controlling a Networked Projector Using a Web Browser](#)

Solutions When Network Alert E-Mails are Not Received

If you do not receive an e-mail alerting you to problems with a projector over the network, try the following solutions:

- Make sure the projector is turned on and connected to the network correctly. (If an error shut down the projector, it cannot send an e-mail.)
- Make sure you set up the projector e-mail alert settings correctly on the projector's network Mail menu or in the network software.
- Set the **Standby Mode** setting to **Communication On** so the network software can monitor the projector in standby mode.

Parent topic: [Solving Network Problems](#)

Related references

[Projector Network Settings - Network Menu](#)

[Projector Setup Settings - Extended Menu](#)

Where to Get Help

If you need to contact Epson for technical support services, use the following support options.

Internet Support

Visit Epson's support website at epson.com/support (U.S.) or epson.ca/support (Canada) for solutions to common problems with your projector. You can download utilities and documentation, get FAQs and troubleshooting advice, or e-mail Epson with your questions.

Speak to a Support Representative

To use the Epson PrivateLine Support service, call (800) 637-7661. This service is available for the duration of your warranty period. You may also speak with a projector support specialist by dialing (562) 276-4394 (U.S.) or (905) 709-3839 (Canada).

Support hours are 6 AM to 8 PM, Pacific Time, Monday through Friday and 7 AM to 4 PM, Pacific Time, Saturday.

Days and hours of support are subject to change without notice. Toll or long distance charges may apply.

Before you call, have the following information ready:

- Product name
- Product serial number (located on the bottom or rear of the projector, or in the menu system)
- Proof of purchase (such as a store receipt) and date of purchase
- Computer or video configuration
- Description of the problem

Purchase Supplies and Accessories

You can purchase screens, other optional accessories, and replacement parts from an Epson authorized reseller. To find the nearest reseller, call 800-GO-EPSON (800-463-7766). Or you can purchase online at epsonstore.com (U.S. sales) or epson.ca (Canadian sales).

To purchase a replacement remote control, call (562) 276-4394 (U.S.) or (905) 709-3839 (for dealer referral in Canada).

Parent topic: [Solving Problems](#)

Technical Specifications

These sections list the technical specifications of your projector.

[General Projector Specifications](#)

[Projector Light Source Specifications](#)

[Remote Control Specifications](#)

[Projector Dimension Specifications](#)

[Projector Electrical Specifications](#)

[Projector Environmental Specifications](#)

[Projector Safety and Approvals Specifications](#)

[Supported Video Display Formats](#)

General Projector Specifications

Type of display	Poly-silicon TFT active matrix
Resolution	1920 × 1200 pixels (WUXGA)
Lens	Pro L1100U/L1200U/L1300U/L1405U: F=1.7 to 2.3 Focal length: 24.02 to 38.24 mm Pro L1500U/L1505U: F=1.8 to 2.5 Focal length: 36 to 57.35 mm
Color reproduction	Full color, up to 1 billion colors

Brightness

Note: Color brightness (color light output) and white brightness (white light output) will vary depending on usage conditions. Color light output measured in accordance with IDMS 15.4; white light output measured in accordance with ISO 21118.

Pro L100U:

Normal Light Source Mode:

White light output 6000 lumens (ISO 21118 standard)

Color light output 6000 lumens

Quiet or Extended Light Source Mode:

White light output 4200 lumens (ISO 21118 standard)

Pro L1200U:

Normal Light Source Mode:

White light output 7000 lumens (ISO 21118 standard)

Color light output 7000 lumens

Quiet or Extended Light Source Mode:

White light output 4900 lumens (ISO 21118 standard)

Pro L1300U/L1405U:

Normal Light Source Mode:

White light output 8000 lumens (ISO 21118 standard)

Color light output 8000 lumens

Quiet or Extended Light Source Mode:

White light output 5600 lumens (ISO 21118 standard)

Pro L1500U/L1505U:

Normal Light Source Mode:

White light output 12000 lumens (ISO 21118 standard)

Color light output 12000 lumens

Quiet or Extended Light Source Mode:

White light output 8400 lumens (ISO 21118 standard)

Contrast ratio

Over 2,500,000:1 with Dynamic Color Mode, Normal Light Source Mode, Wide Zoom, Lens Shift centered, and Light Optimizer on

Image size (in native aspect ratio)	Pro L1100U/L1200U/L1300U/L1405U: 50 inches (1.27 m) to 300 inches (7.62 m) Pro L1500U/L1505U: 60 inches (1.52 m) to 500 inches (12.7 m)
Projection distance (in native aspect ratio)	Pro L1100U/L1200U/L1300U/L1405U: 60.2 inches (1.53 m) to 594.5 inches (15.10 m) Pro L1500U/L1505U: 78.3 inches (1.99 m) to 1093.31 inches (27.77 m)
Projection methods	Front, rear, ceiling-mounted
Optical aspect ratio (width-to-height)	16:10
Focus adjustment	Powered
Zoom adjustment	Powered
Zoom ratio (Tele-to-Wide)	Pro L1100U/L1200U/L1300U/L1405U: 1 to 1.6 Pro L1500U/L1505U: 1 to 1.61
Internal sound system	Pro L1100U/L1200U/L1300U/L1405U: 10 W monaural Pro L1500U/L1505U: N/A

Noise level	<p>Pro L1100U/L1200U: 34 dB (Normal Light Source Mode) 28 dB (Quiet Light Source Mode)</p> <p>Pro L1300U/L1405U: 35 dB (Normal Light Source Mode) 29 dB (Quiet Light Source Mode)</p> <p>Pro 1500U/L1505U: 39 dB (Normal Light Source Mode) 33 dB (Quiet Light Source Mode)</p>
Keystone correction angle	<p>± 45° vertical (Tele Zoom with Standard Zoom lens) ± 30° horizontal (Tele Zoom with Standard Zoom lens)</p>
USB Type B port compatibility	USB 1.1 and 2.0 compliant for firmware update or copying menu settings
USB Type A port compatibility	One USB 1.1 and 2.0 compliant port for wireless LAN, firmware update, or copying menu settings

Parent topic: [Technical Specifications](#)

Projector Light Source Specifications

Type	Laser Diode
Power consumption (Normal Light Source Mode)	<p>Pro L1100U: 290 W</p> <p>Pro L1200U: 385 W</p> <p>Pro L1300U/L1405U: 430 W</p> <p>Pro L1500U/L1505U: 670 W</p>

Light source output power	Pro L1100U: 108 W Pro L1200U: 144 W Pro L1300U/L1405U: 162 W Pro L1500U/L1505U: 252 W
Wavelength	450 to 460 nm
Light source life	Normal or Quiet Light Source Mode: Up to about 20000 hours Extended Light Source Mode: Up to about 30000 hours

Note: Turn off this product when not in use to prolong the life of the projector. Laser life will vary depending upon mode selected, environmental conditions, and usage. Brightness decreases over time.

Parent topic: [Technical Specifications](#)

Remote Control Specifications

Reception range	98.4 feet (30 m)
Batteries	Two alkaline or manganese AA

Parent topic: [Technical Specifications](#)

Projector Dimension Specifications

Height (excluding feet)	7.3 inches (185 mm)
Width	23.1 inches (586 mm)
Depth	19.4 inches (492 mm)

Weight**Pro L1100U:**

44.4 lb (20.1 kg)

Pro L1200U:

45.4 lb (20.6 kg)

Pro L1300U/L1405U:

45.5 lb (20.7 kg)

Pro L1500U/L1505U:

51.9 lb (23.5 kg)

Parent topic: [Technical Specifications](#)**Projector Electrical Specifications****Rated frequency**

50/60 Hz

Power supply100 to 240 VAC \pm 10%**Pro L100U:**

4.9 to 2.2 A

Pro L1200U:

6.0 to 2.7 A

Pro L1300U/L1405U:

6.7 to 3.0 A

Pro L1500U/L1505U:

9.6 to 4.2 A

Power consumption

(100 to 120 V)

Operating:

Pro L100U:

Normal Light Source Mode: 479 W

Extended Light Source Mode: 327 W

Pro L1200U:

Normal Light Source Mode: 594 W

Extended Light Source Mode: 400 W

Pro L1300U/L1405U:

Normal Light Source Mode: 658 W

Extended Light Source Mode: 434 W

Pro L1500U/L1505U:

Normal Light Source Mode: 955 W

Extended Light Source Mode: 597 W

Standby:

Pro L100U/L1200U/L1300U/L1405U:

0.22 W (Communication Off), 2.3 W (Communication On)

Pro L1500U/L1505U:

0.23 W (Communication Off), 2.2 W (Communication On)

Power consumption

(220 to 240 V)

Operating:

Pro L100U:

Normal Light Source Mode: 454 W

Extended Light Source Mode: 313 W

Pro L1200U:

Normal Light Source Mode: 566 W

Extended Light Source Mode: 384 W

Pro L1300U/L1405U:

Normal Light Source Mode: 625 W

Extended Light Source Mode: 417 W

Pro L1500U/L1505U:

Normal Light Source Mode: 908 W

Extended Light Source Mode: 597 W

Standby:

Pro L100U/L1200U/L1300U/L1405U:

0.28 W (Communication Off), 2.4 W (Communication On)

Pro L1500U/L1505U:

0.33 W (Communication Off), 2.3 W (Communication On)

Parent topic: [Technical Specifications](#)

Projector Environmental Specifications

Temperature	Operating: Up to 4921 feet (1500 m): 32 to 113 °F (0 to 45 °C) 4921 feet (1500 m) to 10000 feet (3048 m) with High Altitude Mode enabled: 32 to 104 °F (0 to 40 °C) Brightness automatically dims at these altitudes/operating temperatures: Up to 4921 feet (1500 m): 122 °F (50 °C) 4921 feet (1500 m) to 10000 feet (3048 m): 113 °F (45 °C) Storage: 14 to 140 °F (–10 to 60 °C)
Humidity (relative, non-condensing)	Operating: 20 to 80% Storage: 10 to 90%
Operating altitude	Up to 4921 feet (1500 m) Up to 10000 feet (3048 m) with High Altitude Mode enabled

Parent topic: [Technical Specifications](#)

Projector Safety and Approvals Specifications

United States	FCC Part 15 Class B UL60950-1 2nd edition (cTUVus Mark)
Canada	ICES-003 Class B CSA C22.2 No. 60950-1-07 (cTUVus Mark)

Parent topic: [Technical Specifications](#)

Supported Video Display Formats

For best results, your computer's monitor port or video card resolution should be set to display in the projector's native resolution. However, your projector includes Epson's SizeWise chip that supports other computer display resolutions, so your image will be resized to fit automatically.

Your computer's monitor port or video card refresh rate (vertical frequency) must be compatible with the projector. (See your computer or video card manual for details.)

The table here lists the compatible refresh rate and resolution for each compatible video display format.

Display format	Refresh rate (in Hz)	Resolution (in pixels)
Computer signals (analog RGB)		
VGA	60/72/75/85	640 × 480
SVGA	56/60/72/75/85	800 × 600
XGA	60/70/75/85	1024 × 768
WXGA	60	1280 × 768
	60	1366 × 768
	60/75/85	1280 × 800
WXGA+	60/75/85	1440 × 900
WXGA++	60	1600 × 900
SXGA	70/75/85	1152 × 864
	60/75/85	1280 × 960
	60/75/85	1280 × 1024
SXGA+	60/75	1400 × 1050
WSXGA+ ¹	60	1680 × 1050
UXGA	60	1600 × 1200
WUXGA ²	60	1920 × 1200
Component video		
SDTV (480i)	60	720 × 480
SDTV (576i)	50	720 × 576
SDTV (480p)	60	720 × 480
SDTV (576p)	50	720 × 576
HDTV (720p)	50/60	1280 × 720
HDTV (1080i)	50/60	1920 × 1080

Display format	Refresh rate (in Hz)	Resolution (in pixels)
HDTV (1080p) ³	50/60	1920 × 1080
HDMI, DVI-D, and HDBaseT input signals		
VGA	60	640 × 480
SVGA	60	800 × 600
XGA	60	1024 × 768
WXGA	60	1280 × 800
	60	1366 × 768
WXGA+	60	1440 × 900
WXGA++	60	1600 × 900
WSXGA+	60	1680 × 1050
SXGA	60	1280 × 960
	60	1280 × 1024
SXGA+	60	1400 × 1050
UXGA	60	1600 × 1200
WUXGA ³	60	1920 × 1200
QXGA ⁴	60	2048 × 1536
WQHD ⁴	60	2560 × 1440
WQXGA ^{3, 4}	60	2560 × 1600
SDTV (480i/480p)	60	720 × 480
SDTV (576i/576p)	50	720 × 576
HDTV (720p)	50/60	1280 × 720
HDTV (1080i)	50/60	1920 × 1080
HDTV (1080p)	24/30/50/60	1920 × 1080
4Kx2K ⁴	24/25/30/50/60	3840 × 2160
4Kx2K (SMPTE) ⁴	24/50/60	4096 × 2160
SDI input signals (Pro L1405U/L1500U/L1505U only)		

Display format	Refresh rate (in Hz)	Resolution (in pixels)
SDTV (480i)	59.94 (SD-SDI mode)	720 × 480
SDTV (576i)	50 (SD-SDI mode)	720 × 576
HDTV (720p)	50/59.94/60 (HD-SDI mode)	1280 × 720
HDTV (1080i)	50/59.94/60 (HD-SDI mode)	1920 × 1080
HDTV (1080p)	23.98/24/25/29.97/30 (HD-SDI mode)	1920 × 1080
	50.59.94/60 (3G-SDI mode; Level A)	1920 × 1080

¹ Only compatible when **Wide** is selected as the **Resolution** setting

² Compatible only with VESA CVT-RB (Reduced Blanking) input signal

³ Input signals only from the **Computer** port

⁴ HDMI input only

Parent topic: [Technical Specifications](#)

Notices

Check these sections for important notices about your projector.

[Recycling](#)

[Important Safety Information](#)

[Important Safety Instructions](#)

[List of Safety Symbols \(corresponding to IEC60950-1 A2\)](#)

[FCC Compliance Statement](#)

[Open Source Software License](#)

[Trademarks](#)

[Copyright Notice](#)

Recycling

Epson offers a recycling program for end of life products. Please go to [this site](#) for information on how to return your products for proper disposal.

Parent topic: [Notices](#)

Important Safety Information

Caution: Never look into the projector lens when the laser is turned on; the bright light can damage your eyes. Never let children look into the lens when it is on. Never open any cover on the projector, except the filter covers. Dangerous electrical voltages inside the projector can severely injure you. Except as specifically explained in this *User's Guide*, do not attempt to service this product yourself. Refer all servicing to qualified service personnel.

Warning: The projector and its accessories come packaged in plastic bags. Keep plastic bags away from small children to avoid any risk of suffocation.

Parent topic: [Notices](#)

Important Safety Instructions

Follow these safety instructions when setting up and using the projector:

- Do not look into the lens when the projector is on. The bright light can damage your eyes. Avoid standing in front of the projector so the bright light does not shine into your eyes.

- Do not place the projector on an unstable cart, stand, or table.
- If the projector is mounted on a ceiling or wall, it should be installed by qualified technicians using mounting hardware designed for use with this projector.
- When installing or adjusting a ceiling or wall mount, do not use adhesives to prevent the screws from loosening and do not use oils or lubricants. This may cause the projector case to crack and the projector to fall from its ceiling mount. This could cause serious injury to anyone under the mount and could damage the projector.
- Do not use the projector near water, sources of heat, high-voltage electrical wires, or sources of magnetic fields.
- Use the type of power source indicated on the projector. Use of a different power source may result in fire or electric shock. If you are not sure of the power available, consult your dealer or power company.
- Place the projector near a wall outlet where the plug can be easily unplugged.
- Take the following precautions when handling the plug: Do not hold the plug with wet hands. Do not insert the plug into a dusty outlet. Insert the plug firmly into the outlet. Do not pull the power cord when disconnecting the plug; always be sure to hold the plug when disconnecting it. Do not overload wall outlets, extension cords, or power strips. Failure to comply with these precautions could result in fire or electric shock.
- Do not place the projector where the cord can be walked on. This may result in fraying or damage to the plug.
- Unplug the projector from the wall outlet and allow to cool before cleaning. Use a dry cloth (or, for stubborn dirt or stains, a moist cloth that has been wrung dry) for cleaning. Do not use liquid or aerosol cleaners, any sprays containing flammable gas, or solvents such as alcohol, paint thinner, or benzene.
- Do not block the slots and openings in the projector case. They provide ventilation and prevent the projector from overheating. Do not operate the projector on a sofa, rug, or other soft surface, or set it on top of loose papers. Do not cover the projector with a blanket, curtain, or tablecloth. If you are setting up the projector near a wall, leave at least 7.9 inches (20 cm) of space between the wall and the projector.
- Do not operate the projector in a closed-in cabinet unless proper ventilation is provided.
- Never allow objects of any kind to enter any openings in the projector. Do not leave objects, especially flammable objects, near the projector. Never spill liquid of any kind into the projector.
- If you are using two or more projectors side-by-side, leave at least 20 inches (50 cm) of space between the projectors to allow for proper ventilation.
- You may need to clean the air filter and vent. A clogged air filter or vent can block ventilation needed to cool the projector. Do not use canned air, or the gases may leave a residue.

- Do not store the projector outdoors for an extended length of time.
- Except as specifically explained in this manual, do not attempt to service this product yourself. Refer all servicing to qualified personnel. Opening or removing covers may expose you to dangerous voltages and other hazards.
- Never open any covers on the projector except as specifically explained in this manual. Never attempt to disassemble or modify the projector. Refer all repairs to qualified service personnel.
- Unplug the projector from the wall outlet and refer servicing to qualified service personnel under the following conditions: if it does not operate normally when you follow the operating instructions, or exhibits a distinct change in performance; if smoke, strange odors, or strange noises come from the projector; if the power cord or plug is damaged or frayed; if liquid or foreign objects get inside the projector, or if it has been exposed to rain or water; if it has been dropped or the housing has been damaged.
- Do not touch the plug during an electrical storm. Otherwise, you may receive an electric shock.
- Unplug the projector when it will not be used for extended periods.
- Do not use the projector where it may be exposed to rain, water, or excessive humidity.
- Do not use or store the projector where it may be exposed to smoke, steam, corrosive gases, excessive dust, vibration, or shock.
- Do not use the projector where flammable or explosive gases may be present.
- Do not use or store the projector or remote control in a hot location, such as near a heater, in direct sunlight, or in a closed vehicle.
- If you use the projector in a country other than where you purchased it, use the correct power cord for that country.
- Do not stand on the projector or place heavy objects on it.
- Do not use the projector outside of the required temperature range below:
32 to 113 °F (0 to 45 °C) at an altitude of 4921 feet (1500 m) or less, or 32 to 104 °F (0 to 40 °C) at a higher altitude
Doing so may cause an unstable display and could lead to projector damage. Do not use or store the projector where it may be exposed to sudden changes in temperature.
- Do not store the projector outside of the required temperature range of 14 to 140 °F (–10 to 60 °C) or in direct sunlight for long periods of time. Doing so may cause damage to the case.
- Do not place anything that can become warped or damaged by heat near the exhaust vents. Do not bring your hands or face close to the vents while projection is in progress. Do not bring your face close to the projector while it is in use.

- Before you move the projector, make sure its power is turned off, the plug is disconnected from the outlet, and all cables are disconnected.
- Do not place the source of an open flame, such as a lit candle, on or near the projector.
- Do not block the lens during projection using a book or any other object. This could damage the projector or cause a fire.
- Do not modify the power cord. Do not place heavy objects on top of the power cord or bend, twist, or pull it excessively. Keep the power cord away from hot electrical appliances.
- Always attach the lens cover to the lens when not using the projector to prevent the lens from becoming dirty or damaged.

WARNING: The cords included with this product contain chemicals, including lead, known to the State of California to cause birth defects or other reproductive harm. ***Wash hands after handling.*** (This notice is provided in accordance with Proposition 65 in Cal. Health & Safety Code § 25249.5 and following.)

[Laser Safety Information](#)

[Laser Light Source Warning](#)

[Restriction of Use](#)

Parent topic: [Notices](#)

Laser Safety Information

This projector is a Class 3R laser product that complies with the IEC60825-1 international standard for lasers. Follow these safety instructions when using the projector.

- If an error occurs in the projector, turn off the power and unplug the projector immediately. Continuing to use the projector could result in an electric shock, fire, or visual impairment. Contact Epson support.
- Do not attempt to disassemble or modify the projector. The projector contains a high-power laser component. Serious injury could result.
- Do not look into the lens during projection. Also, do not look into the lens using optical devices, such as a magnifying glass or telescope. This could cause visual impairment.
- When turning on the projector at a distance using the remote control, make sure no one is looking into the lens.
- Do not allow small children to operate the projector. Children must be accompanied by an adult.
- Do not apply optical devices, such as a magnifying glass or reflector, to the projected image. Using the projector may result in physical harm, fire, or an accident.
- Before using the projector, make sure there is nothing in the area that could reflect the projected image.

- When disposing of the projector, do not disassemble it. Dispose of the projector in accordance with your local or national laws and regulations.

Labels are attached to the projector to indicate it is a Class 3R product and complies with FDA performance standards for laser products except for deviations pursuant to Laser Notice N. 50, dated June 24, 2007:

- **Inside**



- Top

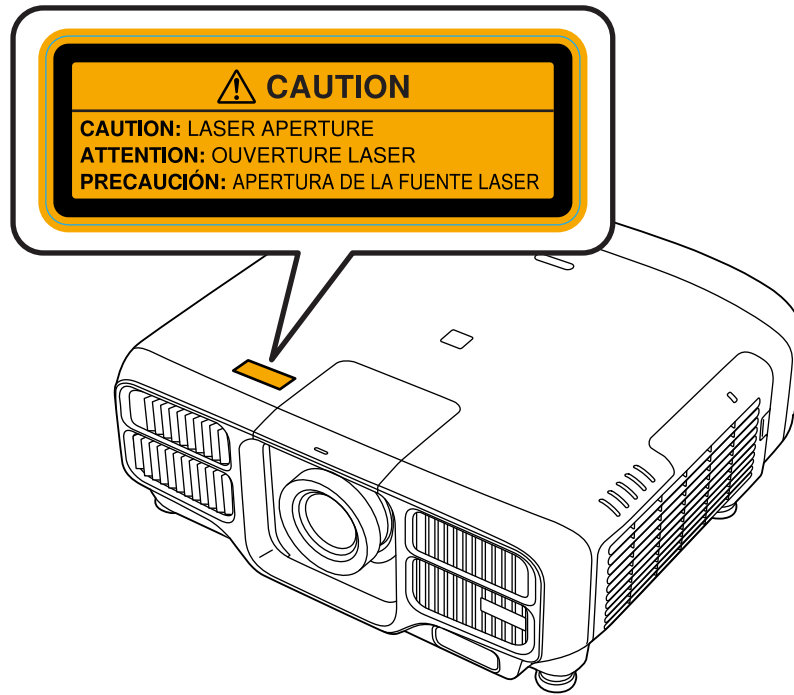

- Pro L1100U Side

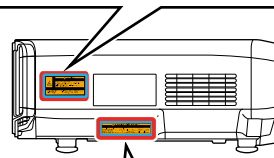
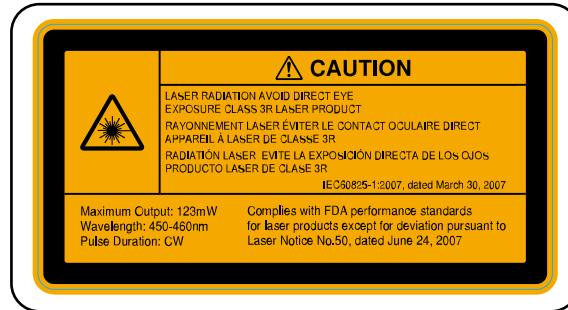

Pro L1200U Side

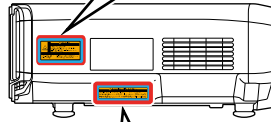
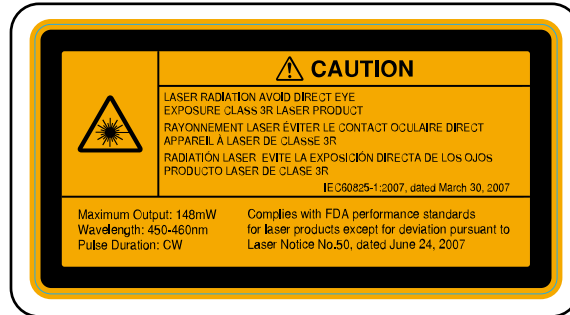

Pro L1300U/L1405U Side

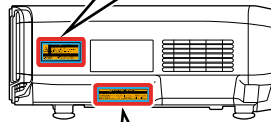
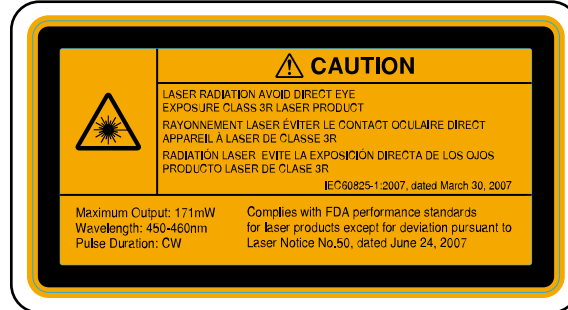

Pro L1500U/L1505U Side

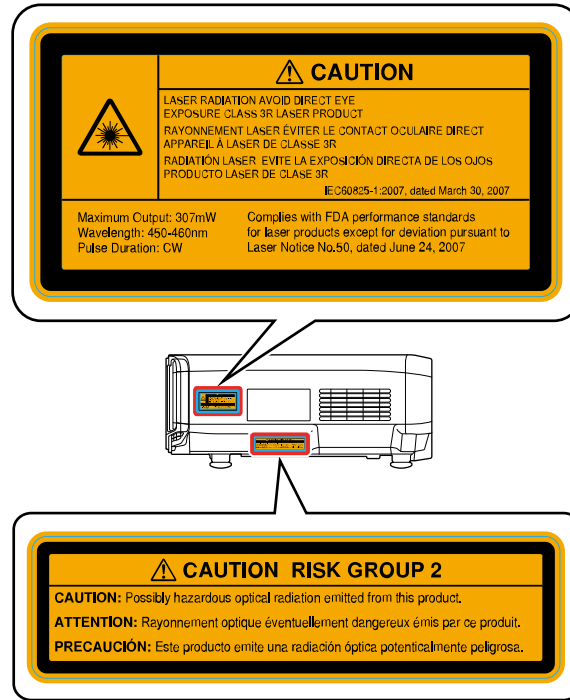

Parent topic: [Important Safety Instructions](#)

Laser Light Source Warning

Refer to the table here for the Exposure Hazard Values (EHV) in accordance with the IEC62471-2:2009 standard. The EHV indicates the hazard level for objects in front of the light source for 0.25 seconds at a distance of 7.9 inches (20 cm). The higher the value, the greater the hazard level.

Lens	Exposure Hazard Value			
	Pro L1100U	Pro L1200U	Pro L1300U Pro L1405U	Pro L1500U Pro L1505U
ELPLM08	0.5	0.5	0.5	0.5

Lens	Exposure Hazard Value			
	Pro L1100U	Pro L1200U	Pro L1300U Pro L1405U	Pro L1500U Pro L1505U
ELPLM09 ELPLS04	0.6	0.6	0.6	0.6
ELPLX01	<0.5	<0.5	<0.5	—
ELPLU03	<0.5	<0.5	<0.5	<0.5
ELPLU04 ELPLU02	<0.5	<0.5	<0.5	<0.5
ELPLW05	<0.5	<0.5	<0.5	<0.5
ELPLW06 ELPLW04	<0.5	<0.5	<0.5	<0.5
ELPLM10 ELPLM06	0.6	0.6	0.6	0.7
ELPLM11 ELPLM07	0.6	0.6	0.6	0.7
ELPLL08 ELPLL07	0.5	0.5	0.5	0.7

Parent topic: [Important Safety Instructions](#)

Restriction of Use







When this product is used for applications requiring high reliability/safety such as transportation devices related to aviation, rail, marine, automotive; disaster prevention devices; various safety devices; or functional/precision devices, you should use this product only after giving consideration to including fail-safes and redundancies into your design to maintain safety and total system reliability.







Because this product was not intended for use in applications requiring extremely high reliability/safety such as aerospace equipment, main communication equipment, nuclear power control equipment, or medical equipment related to direct medical care, please make your own judgment on this product's suitability after a full evaluation.



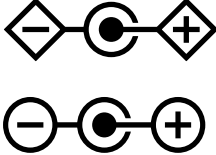

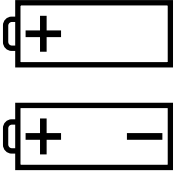

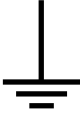
Parent topic: [Important Safety Instructions](#)



List of Safety Symbols (corresponding to IEC60950-1 A2)

The following table lists the meaning of the safety symbols labeled on the equipment.

No.	Symbol	Approved Standards	Description
1		IEC60417 No.5007	"ON" (power) To indicate connection to the mains.
2		IEC60417 No.5008	"OFF" (power) To indicate disconnection from the mains.
3		IEC60417 No.5009	Stand-by To identify the switch or switch position by means of which part of the equipment is switched on in order to bring it into the stand-by condition.
4		ISO7000 No.0434B IEC3864-B3.1	Caution To identify general caution when using the product.
5		IEC60417 No.5041	Caution, hot surface To indicate that the marked item can be hot and should not be touched without taking care.
6		IEC60417 No.6042 ISO3864-B3.6	Caution, risk of electric shock To identify equipment that has risk of electric shock.
7		IEC60417 No.5957	For indoor use only To identify electrical equipment designed primarily for indoor use.

No.	Symbol	Approved Standards	Description
8		IEC60417 No.5926	Polarity of DC power connector To identify the positive and negative connections (the polarity) on a piece of equipment to which a DC power supply may be connected.
9		IEC60417 No.5001B	Battery, general On battery powered equipment. To identify a device for instance a cover for the battery compartment, or the connector terminals.
10		IEC60417 No.5002	Positioning of cell To identify the battery holder itself and to identify the positioning of the cell(s) inside the battery holder.
11		IEC60417 No.5019	Protective earth To identify any terminal which is intended for connection to an external conductor for protection against electric shock in case of a fault, or the terminal of a protective earth electrode.
12		IEC60417 No.5017	Earth To identify an earth (ground) terminal in cases where neither the symbol No.13 is explicitly required.
13		IEC60417 No.5032	Alternating current To indicate on the rating plate that the equipment is suitable for alternating current only; to identify relevant terminals.

No.	Symbol	Approved Standards	Description
14		IEC60417 No.5031	Direct current To indicate on the rating plate that the equipment is suitable for direct current only; to identify relevant terminals.
15		IEC60417 No.5172	Class II equipment To identify equipment meeting the safety requirements specified for Class II equipment according to IEC 61140.
16		ISO 3864	General prohibition To identify actions or operations that are prohibited.
17		ISO 3864	Contact prohibition To indicate injury that could occur due to touching a specific part of the equipment.
18		—	Never look into the optical lens while the projector is on.
19		—	To indicate that the marked item don't place anything on projector.
20		ISO3864 IEC60825-1	Caution, laser radiation To indicate the equipment has a laser radiation part.
21		ISO 3864	Disassembly prohibition To indicate a risk of injury, such as electric shock, if the equipment is disassembled.

No.	Symbol	Approved Standards	Description
22		—	Never look into the lens while the LED for lighting is on.
23		IEC60417 No. 5266	Standby, partial standby To indicate that part of the equipment is in the ready status.
24		ISO3864 IEC60417 No. 5057	Caution, movable parts To indicate that you must keep away from movable parts according to protection standards.

Parent topic: [Notices](#)

FCC Compliance Statement

For United States Users

This equipment has been tested and found to comply with the limits for a Class B digital device, pursuant to Part 15 of the FCC Rules. These limits are designed to provide reasonable protection against harmful interference in a residential installation. This equipment generates, uses, and can radiate radio frequency energy and, if not installed and used in accordance with the instructions, may cause harmful interference to radio communications. However, there is no guarantee that interference will not occur in a particular installation. If this equipment does cause interference to radio and television reception, which can be determined by turning the equipment off and on, the user is encouraged to try to correct the interference by one or more of the following measures:

- Reorient or relocate the receiving antenna.
- Increase the separation between the equipment and receiver.
- Connect the equipment into an outlet on a circuit different from that to which the receiver is connected.
- Consult the dealer or an experienced radio/TV technician for help.

WARNING

The connection of a non-shielded equipment interface cable to this equipment will invalidate the FCC Certification or Declaration of this device and may cause interference levels which exceed the limits established by the FCC for this equipment. It is the responsibility of the user to obtain and use a shielded equipment interface cable with this device. If this equipment has more than one interface connector, do

not leave cables connected to unused interfaces. Changes or modifications not expressly approved by the manufacturer could void the user's authority to operate the equipment.

For Canadian Users

CAN ICES-3(B)/NMB-3(B)

Parent topic: [Notices](#)

Open Source Software License

GNU GPL

This projector product includes the open source software programs which apply the GNU General Public License Version 2 or later version ("GPL Programs").

We provide the source code of the GPL Programs until five (5) years after the discontinuation of same model of this projector product.

If you desire to receive the source code of the GPL Programs, contact Epson.

These GPL Programs are WITHOUT ANY WARRANTY; without even the implied warranty of MERCHANTABILITY AND FITNESS FOR A PARTICULAR PURPOSE. See the GNU General Public License for more details.

The list of GPL Programs is as follows and the names of author are described in the source code of the GPL Programs

The list of GPL Programs

- busybox-1.21.0
- iptables-1.4.20
- linux-3.4.49
- patches
- udhcp 0.9.8
- wireless_tools 29
- dbus-1.6.18
- EPSON original drivers
- Stonestreet One Drivers

The GNU General Public License Version 2 is as follows. You also can see the GNU General Public License Version 2 at <http://www.gnu.org/licenses/>.

GNU GENERAL PUBLIC LICENSE

Version 2, June 1991

Copyright (C) 1989, 1991 Free Software Foundation, Inc., 51 Franklin Street, Fifth Floor, Boston, MA 02110-1301 USA Everyone is permitted to copy and distribute verbatim copies of this license document, but changing it is not allowed.

Preamble

The licenses for most software are designed to take away your freedom to share and change it. By contrast, the GNU General Public License is intended to guarantee your freedom to share and change free software—to make sure the software is free for all its users. This General Public License applies to most of the Free Software Foundation's software and to any other program whose authors commit to using it. (Some other Free Software Foundation software is covered by the GNU Lesser General Public License instead.) You can apply it to your programs, too.

When we speak of free software, we are referring to freedom, not price. Our General Public Licenses are designed to make sure that you have the freedom to distribute copies of free software (and charge for this service if you wish), that you receive source code or can get it if you want it, that you can change the software or use pieces of it in new free programs; and that you know you can do these things.

To protect your rights, we need to make restrictions that forbid anyone to deny you these rights or to ask you to surrender the rights. These restrictions translate to certain responsibilities for you if you distribute copies of the software, or if you modify it.

For example, if you distribute copies of such a program, whether gratis or for a fee, you must give the recipients all the rights that you have. You must make sure that they, too, receive or can get the source code. And you must show them these terms so they know their rights.

We protect your rights with two steps: (1) copyright the software, and (2) offer you this license which gives you legal permission to copy, distribute and/or modify the software.

Also, for each author's protection and ours, we want to make certain that everyone understands that there is no warranty for this free software. If the software is modified by someone else and passed on, we want its recipients to know that what they have is not the original, so that any problems introduced by others will not reflect on the original authors' reputations.

Finally, any free program is threatened constantly by software patents. We wish to avoid the danger that redistributors of a free program will individually obtain patent licenses, in effect making the program proprietary. To prevent this, we have made it clear that any patent must be licensed for everyone's free use or not licensed at all.

The precise terms and conditions for copying, distribution and modification follow.

GNU GENERAL PUBLIC LICENSE TERMS AND CONDITIONS FOR COPYING, DISTRIBUTION AND MODIFICATION

0. This License applies to any program or other work which contains a notice placed by the copyright holder saying it may be distributed under the terms of this General Public License. The "Program", below, refers to any such program or work, and a "work based on the Program" means either the Program or any derivative work under copyright law: that is to say, a work containing the Program or a portion of it, either verbatim or with modifications and/or translated into another language. (Hereinafter, translation is included without limitation in the term "modification".) Each licensee is addressed as "you".

Activities other than copying, distribution and modification are not covered by this License; they are outside its scope. The act of running the Program is not restricted, and the output from the Program is covered only if its contents constitute a work based on the Program (independent of having been made by running the Program). Whether that is true depends on what the Program does.

1. You may copy and distribute verbatim copies of the Program's source code as you receive it, in any medium, provided that you conspicuously and appropriately publish on each copy an appropriate copyright notice and disclaimer of warranty; keep intact all the notices that refer to this License and to the absence of any warranty; and give any other recipients of the Program a copy of this License along with the Program.

You may charge a fee for the physical act of transferring a copy, and you may at your option offer warranty protection in exchange for a fee.

2. You may modify your copy or copies of the Program or any portion of it, thus forming a work based on the Program, and copy and distribute such modifications or work under the terms of Section 1 above, provided that you also meet all of these conditions:

a) You must cause the modified files to carry prominent notices stating that you changed the files and the date of any change.

b) You must cause any work that you distribute or publish, that in whole or in part contains or is derived from the Program or any part thereof, to be licensed as a whole at no charge to all third parties under the terms of this License.

c) If the modified program normally reads commands interactively when run, you must cause it, when started running for such interactive use in the most ordinary way, to print or display an announcement including an appropriate copyright notice and a notice that there is no warranty (or else, saying that you provide a warranty) and that users may redistribute the program under these conditions, and telling the user how to view a copy of this License. (Exception: if the Program itself is interactive but does not normally print such an announcement, your work based on the Program is not required to print an announcement.)

These requirements apply to the modified work as a whole. If identifiable sections of that work are not derived from the Program, and can be reasonably considered independent and separate works in themselves, then this License, and its terms, do not apply to those sections when you distribute them as

separate works. But when you distribute the same sections as part of a whole which is a work based on the Program, the distribution of the whole must be on the terms of this License, whose permissions for other licensees extend to the entire whole, and thus to each and every part regardless of who wrote it.

Thus, it is not the intent of this section to claim rights or contest your rights to work written entirely by you; rather, the intent is to exercise the right to control the distribution of derivative or collective works based on the Program.

In addition, mere aggregation of another work not based on the Program with the Program (or with a work based on the Program) on a volume of a storage or distribution medium does not bring the other work under the scope of this License.

3. You may copy and distribute the Program (or a work based on it, under Section 2) in object code or executable form under the terms of Sections 1 and 2 above provided that you also do one of the following:

- a) Accompany it with the complete corresponding machine-readable source code, which must be distributed under the terms of Sections 1 and 2 above on a medium customarily used for software interchange; or,
- b) Accompany it with a written offer, valid for at least three years, to give any third party, for a charge no more than your cost of physically performing source distribution, a complete machine-readable copy of the corresponding source code, to be distributed under the terms of Sections 1 and 2 above on a medium customarily used for software interchange; or,
- c) Accompany it with the information you received as to the offer to distribute corresponding source code. (This alternative is allowed only for noncommercial distribution and only if you received the program in object code or executable form with such an offer, in accord with Subsection b above.)

The source code for a work means the preferred form of the work for making modifications to it. For an executable work, complete source code means all the source code for all modules it contains, plus any associated interface definition files, plus the scripts used to control compilation and installation of the executable. However, as a special exception, the source code distributed need not include anything that is normally distributed (in either source or binary form) with the major components (compiler, kernel, and so on) of the operating system on which the executable runs, unless that component itself accompanies the executable.

If distribution of executable or object code is made by offering access to copy from a designated place, then offering equivalent access to copy the source code from the same place counts as distribution of the source code, even though third parties are not compelled to copy the source along with the object code.

4. You may not copy, modify, sublicense, or distribute the Program except as expressly provided under this License. Any attempt otherwise to copy, modify, sublicense or distribute the Program is void, and will automatically terminate your rights under this License. However, parties who have received copies, or

rights, from you under this License will not have their licenses terminated so long as such parties remain in full compliance.

5. You are not required to accept this License, since you have not signed it. However, nothing else grants you permission to modify or distribute the Program or its derivative works. These actions are prohibited by law if you do not accept this License. Therefore, by modifying or distributing the Program (or any work based on the Program), you indicate your acceptance of this License to do so, and all its terms and conditions for copying, distributing or modifying the Program or works based on it.

6. Each time you redistribute the Program (or any work based on the Program), the recipient automatically receives a license from the original licensor to copy, distribute or modify the Program subject to these terms and conditions. You may not impose any further restrictions on the recipients' exercise of the rights granted herein. You are not responsible for enforcing compliance by third parties to this License.

7. If, as a consequence of a court judgment or allegation of patent infringement or for any other reason (not limited to patent issues), conditions are imposed on you (whether by court order, agreement or otherwise) that contradict the conditions of this License, they do not excuse you from the conditions of this License. If you cannot distribute so as to satisfy simultaneously your obligations under this License and any other pertinent obligations, then as a consequence you may not distribute the Program at all. For example, if a patent license would not permit royalty-free redistribution of the Program by all those who receive copies directly or indirectly through you, then the only way you could satisfy both it and this License would be to refrain entirely from distribution of the Program.

If any portion of this section is held invalid or unenforceable under any particular circumstance, the balance of the section is intended to apply and the section as a whole is intended to apply in other circumstances.

It is not the purpose of this section to induce you to infringe any patents or other property right claims or to contest validity of any such claims; this section has the sole purpose of protecting the integrity of the free software distribution system, which is implemented by public license practices. Many people have made generous contributions to the wide range of software distributed through that system in reliance on consistent application of that system; it is up to the author/donor to decide if he or she is willing to distribute software through any other system and a licensee cannot impose that choice.

This section is intended to make thoroughly clear what is believed to be a consequence of the rest of this License.

8. If the distribution and/or use of the Program is restricted in certain countries either by patents or by copyrighted interfaces, the original copyright holder who places the Program under this License may add an explicit geographical distribution limitation excluding those countries, so that distribution is permitted only in or among countries not thus excluded. In such case, this License incorporates the limitation as if written in the body of this License.

9. The Free Software Foundation may publish revised and/or new versions of the General Public License from time to time. Such new versions will be similar in spirit to the present version, but may differ in detail to address new problems or concerns.

Each version is given a distinguishing version number. If the Program specifies a version number of this License which applies to it and "any later version", you have the option of following the terms and conditions either of that version or of any later version published by the Free Software Foundation. If the Program does not specify a version number of this License, you may choose any version ever published by the Free Software Foundation.

10. If you wish to incorporate parts of the Program into other free programs whose distribution conditions are different, write to the author to ask for permission. For software which is copyrighted by the Free Software Foundation, write to the Free Software Foundation; we sometimes make exceptions for this. Our decision will be guided by the two goals of preserving the free status of all derivatives of our free software and of promoting the sharing and reuse of software generally.

NO WARRANTY

11. BECAUSE THE PROGRAM IS LICENSED FREE OF CHARGE, THERE IS NO WARRANTY FOR THE PROGRAM, TO THE EXTENT PERMITTED BY APPLICABLE LAW. EXCEPT WHEN OTHERWISE STATED IN WRITING THE COPYRIGHT HOLDERS AND/OR OTHER PARTIES PROVIDE THE PROGRAM "AS IS" WITHOUT WARRANTY OF ANY KIND, EITHER EXPRESSED OR IMPLIED, INCLUDING, BUT NOT LIMITED TO, THE IMPLIED WARRANTIES OF MERCHANTABILITY AND FITNESS FOR A PARTICULAR PURPOSE. THE ENTIRE RISK AS TO THE QUALITY AND PERFORMANCE OF THE PROGRAM IS WITH YOU. SHOULD THE PROGRAM PROVE DEFECTIVE, YOU ASSUME THE COST OF ALL NECESSARY SERVICING, REPAIR OR CORRECTION.

12. IN NO EVENT UNLESS REQUIRED BY APPLICABLE LAW OR AGREED TO IN WRITING WILL ANY COPYRIGHT HOLDER, OR ANY OTHER PARTY WHO MAY MODIFY AND/OR REDISTRIBUTE THE PROGRAM AS PERMITTED ABOVE, BE LIABLE TO YOU FOR DAMAGES, INCLUDING ANY GENERAL, SPECIAL, INCIDENTAL OR CONSEQUENTIAL DAMAGES ARISING OUT OF THE USE OR INABILITY TO USE THE PROGRAM (INCLUDING BUT NOT LIMITED TO LOSS OF DATA OR DATA BEING RENDERED INACCURATE OR LOSSES SUSTAINED BY YOU OR THIRD PARTIES OR A FAILURE OF THE PROGRAM TO OPERATE WITH ANY OTHER PROGRAMS), EVEN IF SUCH HOLDER OR OTHER PARTY HAS BEEN ADVISED OF THE POSSIBILITY OF SUCH DAMAGES.

END OF TERMS AND CONDITIONS

How to Apply These Terms to Your New Programs

If you develop a new program, and you want it to be of the greatest possible use to the public, the best way to achieve this is to make it free software which everyone can redistribute and change under these terms.

To do so, attach the following notices to the program. It is safest to attach them to the start of each source file to most effectively convey the exclusion of warranty; and each file should have at least the "copyright" line and a pointer to where the full notice is found.

<one line to give the program's name and a brief idea of what it does.>

Copyright (C) <year> <name of author>

This program is free software; you can redistribute it and/or modify it under the terms of the GNU General Public License as published by the Free Software Foundation; either version 2 of the License, or (at your option) any later version.

This program is distributed in the hope that it will be useful, but WITHOUT ANY WARRANTY; without even the implied warranty of MERCHANTABILITY or FITNESS FOR A PARTICULAR PURPOSE. See the GNU General Public License for more details.

You should have received a copy of the GNU General Public License along with this program; if not, write to the Free Software Foundation, Inc., 51 Franklin Street, Fifth Floor, Boston, MA 02110-1301 USA.

Also add information on how to contact you by electronic and paper mail.

If the program is interactive, make it output a short notice like this when it starts in an interactive mode:

Gnomovision version 69, Copyright (C) year name of author Gnomovision comes with ABSOLUTELY NO WARRANTY; for details type `show w'. This is free software, and you are welcome to redistribute it under certain conditions; type `show c' for details.

The hypothetical commands `show w' and `show c' should show the appropriate parts of the General Public License. Of course, the commands you use may be called something other than `show w' and `show c'; they could even be mouse-clicks or menu items--whatever suits your program.

You should also get your employer (if you work as a programmer) or your school, if any, to sign a "copyright disclaimer" for the program, if necessary. Here is a sample; alter the names:

Yoyodyne, Inc., hereby disclaims all copyright interest in the program `Gnomovision' (which makes passes at compilers) written by James Hacker.

<signature of Ty Coon>, 1 April 1989

Ty Coon, President of Vice

This General Public License does not permit incorporating your program into proprietary programs. If your program is a subroutine library, you may consider it more useful to permit linking proprietary applications with the library. If this is what you want to do, use the GNU Lesser General Public License instead of this License.

GNU LGPL

This projector product includes the open source software programs which apply the GNU Lesser General Public License Version 2 or later version ("LGPL Programs").

We provide the source code of the LGPL Programs until five (5) years after the discontinuation of same model of this projector product.

If you desire to receive the source code of the LGPL Programs, please contact Epson.

These LGPL Programs are WITHOUT ANY WARRANTY; without even the implied warranty of MERCHANTABILITY AND FITNESS FOR A PARTICULAR PURPOSE. See the GNU General Public License for more details.

The list of LGPL Programs is as follows and the names of author are described in the source code of the LGPL Programs.

LGPL Programs

- SDL-1.2.15
- SDL-Image
- alsa-lib-1.0.27.2
- libdbus-c++-0.9.0
- gencode-3.4.2
- libnl-3.2.24
- libartnet-1.1.2

The GNU Lesser General Public License Version 2 is as follows. You also can see the GNU Lesser General Public License Version 2 at <http://www.gnu.org/licenses/>.

GNU LESSER GENERAL PUBLIC LICENSE

Version 2.1, February 1999

Copyright (C) 1991, 1999 Free Software Foundation, Inc. 51 Franklin Street, Fifth Floor, Boston, MA 02110-1301 USA Everyone is permitted to copy and distribute verbatim copies of this license document, but changing it is not allowed.

[This is the first released version of the Lesser GPL. It also counts as the successor of the GNU Library Public License, version 2, hence the version number 2.1.]

Preamble

The licenses for most software are designed to take away your freedom to share and change it. By contrast, the GNU General Public Licenses are intended to guarantee your freedom to share and change free software—to make sure the software is free for all its users.

This license, the Lesser General Public License, applies to some specially designated software packages—typically libraries—of the Free Software Foundation and other authors who decide to use it. You can use it too, but we suggest you first think carefully about whether this license or the ordinary General Public License is the better strategy to use in any particular case, based on the explanations below.

When we speak of free software, we are referring to freedom of use, not price. Our General Public Licenses are designed to make sure that you have the freedom to distribute copies of free software (and charge for this service if you wish); that you receive source code or can get it if you want it; that you can change the software and use pieces of it in new free programs; and that you are informed that you can do these things.

To protect your rights, we need to make restrictions that forbid distributors to deny you these rights or to ask you to surrender these rights. These restrictions translate to certain responsibilities for you if you distribute copies of the library or if you modify it.

For example, if you distribute copies of the library, whether gratis or for a fee, you must give the recipients all the rights that we gave you. You must make sure that they, too, receive or can get the source code. If you link other code with the library, you must provide complete object files to the recipients, so that they can relink them with the library after making changes to the library and recompiling it. And you must show them these terms so they know their rights.

We protect your rights with a two-step method: (1) we copyright the library, and (2) we offer you this license, which gives you legal permission to copy, distribute and/or modify the library.

To protect each distributor, we want to make it very clear that there is no warranty for the free library. Also, if the library is modified by someone else and passed on, the recipients should know that what they have is not the original version, so that the original author's reputation will not be affected by problems that might be introduced by others.

Finally, software patents pose a constant threat to the existence of any free program. We wish to make sure that a company cannot effectively restrict the users of a free program by obtaining a restrictive license from a patent holder. Therefore, we insist that any patent license obtained for a version of the library must be consistent with the full freedom of use specified in this license.

Most GNU software, including some libraries, is covered by the ordinary GNU General Public License. This license, the GNU Lesser General Public License, applies to certain designated libraries, and is quite different from the ordinary General Public License. We use this license for certain libraries in order to permit linking those libraries into non-free programs.

When a program is linked with a library, whether statically or using a shared library, the combination of the two is legally speaking a combined work, a derivative of the original library. The ordinary General Public License therefore permits such linking only if the entire combination fits its criteria of freedom. The Lesser General Public License permits more lax criteria for linking other code with the library.

We call this license the "Lesser" General Public License because it does Less to protect the user's freedom than the ordinary General Public License. It also provides other free software developers Less of an advantage over competing non-free programs. These disadvantages are the reason we use the ordinary General Public License for many libraries. However, the Lesser license provides advantages in certain special circumstances.

For example, on rare occasions, there may be a special need to encourage the widest possible use of a certain library, so that it becomes a de-facto standard. To achieve this, non-free programs must be allowed to use the library. A more frequent case is that a free library does the same job as widely used non-free libraries. In this case, there is little to gain by limiting the free library to free software only, so we use the Lesser General Public License.

In other cases, permission to use a particular library in non-free programs enables a greater number of people to use a large body of free software. For example, permission to use the GNU C Library in non-free programs enables many more people to use the whole GNU operating system, as well as its variant, the GNU/Linux operating system.

Although the Lesser General Public License is Less protective of the users' freedom, it does ensure that the user of a program that is linked with the Library has the freedom and the wherewithal to run that program using a modified version of the Library.

The precise terms and conditions for copying, distribution and modification follow. Pay close attention to the difference between a "work based on the library" and a "work that uses the library". The former contains code derived from the library, whereas the latter must be combined with the library in order to run.

GNU LESSER GENERAL PUBLIC LICENSE TERMS AND CONDITIONS FOR COPYING, DISTRIBUTION AND MODIFICATION

0. This License Agreement applies to any software library or other program which contains a notice placed by the copyright holder or other authorized party saying it may be distributed under the terms of this Lesser General Public License (also called "this License"). Each licensee is addressed as "you".

A "library" means a collection of software functions and/or data prepared so as to be conveniently linked with application programs (which use some of those functions and data) to form executables.

The "Library", below, refers to any such software library or work which has been distributed under these terms. A "work based on the Library" means either the Library or any derivative work under copyright law: that is to say, a work containing the Library or a portion of it, either verbatim or with modifications

and/or translated straightforwardly into another language. (Hereinafter, translation is included without limitation in the term "modification".)

"Source code" for a work means the preferred form of the work for making modifications to it. For a library, complete source code means all the source code for all modules it contains, plus any associated interface definition files, plus the scripts used to control compilation and installation of the library.

Activities other than copying, distribution and modification are not covered by this License; they are outside its scope. The act of running a program using the Library is not restricted, and output from such a program is covered only if its contents constitute a work based on the Library (independent of the use of the Library in a tool for writing it). Whether that is true depends on what the Library does and what the program that uses the Library does.

1. You may copy and distribute verbatim copies of the Library's complete source code as you receive it, in any medium, provided that you conspicuously and appropriately publish on each copy an appropriate copyright notice and disclaimer of warranty; keep intact all the notices that refer to this License and to the absence of any warranty; and distribute a copy of this License along with the Library.

You may charge a fee for the physical act of transferring a copy, and you may at your option offer warranty protection in exchange for a fee.

2. You may modify your copy or copies of the Library or any portion of it, thus forming a work based on the Library, and copy and distribute such modifications or work under the terms of Section 1 above, provided that you also meet all of these conditions:

a) The modified work must itself be a software library.

b) You must cause the files modified to carry prominent notices stating that you changed the files and the date of any change.

c) You must cause the whole of the work to be licensed at no charge to all third parties under the terms of this License.

d) If a facility in the modified Library refers to a function or a table of data to be supplied by an application program that uses the facility, other than as an argument passed when the facility is invoked, then you must make a good faith effort to ensure that, in the event an application does not supply such function or table, the facility still operates, and performs whatever part of its purpose remains meaningful.

(For example, a function in a library to compute square roots has a purpose that is entirely well-defined independent of the application. Therefore, Subsection 2d requires that any application-supplied function or table used by this function must be optional: if the application does not supply it, the square root function must still compute square roots.)

These requirements apply to the modified work as a whole. If identifiable sections of that work are not derived from the Library, and can be reasonably considered independent and separate works in themselves, then this License, and its terms, do not apply to those sections when you distribute them as separate works. But when you distribute the same sections as part of a whole which is a work based on

the Library, the distribution of the whole must be on the terms of this License, whose permissions for other licensees extend to the entire whole, and thus to each and every part regardless of who wrote it.

Thus, it is not the intent of this section to claim rights or contest your rights to work written entirely by you; rather, the intent is to exercise the right to control the distribution of derivative or collective works based on the Library.

In addition, mere aggregation of another work not based on the Library with the Library (or with a work based on the Library) on a volume of a storage or distribution medium does not bring the other work under the scope of this License.

3. You may opt to apply the terms of the ordinary GNU General Public License instead of this License to a given copy of the Library. To do this, you must alter all the notices that refer to this License, so that they refer to the ordinary GNU General Public License, version 2, instead of to this License. (If a newer version than version 2 of the ordinary GNU General Public License has appeared, then you can specify that version instead if you wish.) Do not make any other change in these notices.

Once this change is made in a given copy, it is irreversible for that copy, so the ordinary GNU General Public License applies to all subsequent copies and derivative works made from that copy.

This option is useful when you wish to copy part of the code of the Library into a program that is not a library.

4. You may copy and distribute the Library (or a portion or derivative of it, under Section 2) in object code or executable form under the terms of Sections 1 and 2 above provided that you accompany it with the complete corresponding machine-readable source code, which must be distributed under the terms of Sections 1 and 2 above on a medium customarily used for software interchange.

If distribution of object code is made by offering access to copy from a designated place, then offering equivalent access to copy the source code from the same place satisfies the requirement to distribute the source code, even though third parties are not compelled to copy the source along with the object code.

5. A program that contains no derivative of any portion of the Library, but is designed to work with the Library by being compiled or linked with it, is called a "work that uses the Library". Such a work, in isolation, is not a derivative work of the Library, and therefore falls outside the scope of this License.

However, linking a "work that uses the Library" with the Library creates an executable that is a derivative of the Library (because it contains portions of the Library), rather than a "work that uses the library". The executable is therefore covered by this License. Section 6 states terms for distribution of such executables.

When a "work that uses the Library" uses material from a header file that is part of the Library, the object code for the work may be a derivative work of the Library even though the source code is not. Whether this is true is especially significant if the work can be linked without the Library, or if the work is itself a library. The threshold for this to be true is not precisely defined by law.

If such an object file uses only numerical parameters, data structure layouts and accessors, and small macros and small inline functions (ten lines or less in length), then the use of the object file is unrestricted, regardless of whether it is legally a derivative work. (Executables containing this object code plus portions of the Library will still fall under Section 6.)

Otherwise, if the work is a derivative of the Library, you may distribute the object code for the work under the terms of Section 6. Any executables containing that work also fall under Section 6, whether or not they are linked directly with the Library itself.

6. As an exception to the Sections above, you may also combine or link a "work that uses the Library" with the Library to produce a work containing portions of the Library, and distribute that work under terms of your choice, provided that the terms permit modification of the work for the customer's own use and reverse engineering for debugging such modifications.

You must give prominent notice with each copy of the work that the Library is used in it and that the Library and its use are covered by this License. You must supply a copy of this License. If the work during execution displays copyright notices, you must include the copyright notice for the Library among them, as well as a reference directing the user to the copy of this License. Also, you must do one of these things:

a) Accompany the work with the complete corresponding machine-readable source code for the Library including whatever changes were used in the work (which must be distributed under Sections 1 and 2 above); and, if the work is an executable linked with the Library, with the complete machine-readable "work that uses the Library", as object code and/or source code, so that the user can modify the Library and then relink to produce a modified executable containing the modified Library. (It is understood that the user who changes the contents of definitions files in the Library will not necessarily be able to recompile the application to use the modified definitions.)

b) Use a suitable shared library mechanism for linking with the Library. A suitable mechanism is one that (1) uses at run time a copy of the library already present on the user's computer system, rather than copying library functions into the executable, and (2) will operate properly with a modified version of the library, if the user installs one, as long as the modified version is interface-compatible with the version that the work was made with.

c) Accompany the work with a written offer, valid for at least three years, to give the same user the materials specified in Subsection 6a, above, for a charge no more than the cost of performing this distribution.

d) If distribution of the work is made by offering access to copy from a designated place, offer equivalent access to copy the above specified materials from the same place.

e) Verify that the user has already received a copy of these materials or that you have already sent this user a copy.

For an executable, the required form of the "work that uses the Library" must include any data and utility programs needed for reproducing the executable from it. However, as a special exception, the materials

to be distributed need not include anything that is normally distributed (in either source or binary form) with the major components (compiler, kernel, and so on) of the operating system on which the executable runs, unless that component itself accompanies the executable.

It may happen that this requirement contradicts the license restrictions of other proprietary libraries that do not normally accompany the operating system. Such a contradiction means you cannot use both them and the Library together in an executable that you distribute.

7. You may place library facilities that are a work based on the Library side-by-side in a single library together with other library facilities not covered by this License, and distribute such a combined library, provided that the separate distribution of the work based on the Library and of the other library facilities is otherwise permitted, and provided that you do these two things:

a) Accompany the combined library with a copy of the same work based on the Library, uncombined with any other library facilities. This must be distributed under the terms of the Sections above.

b) Give prominent notice with the combined library of the fact that part of it is a work based on the Library, and explaining where to find the accompanying uncombined form of the same work.

8. You may not copy, modify, sublicense, link with, or distribute the Library except as expressly provided under this License. Any attempt otherwise to copy, modify, sublicense, link with, or distribute the Library is void, and will automatically terminate your rights under this License. However, parties who have received copies, or rights, from you under this License will not have their licenses terminated so long as such parties remain in full compliance.

9. You are not required to accept this License, since you have not signed it. However, nothing else grants you permission to modify or distribute the Library or its derivative works. These actions are prohibited by law if you do not accept this License. Therefore, by modifying or distributing the Library (or any work based on the Library), you indicate your acceptance of this License to do so, and all its terms and conditions for copying, distributing or modifying the Library or works based on it.

10. Each time you redistribute the Library (or any work based on the Library), the recipient automatically receives a license from the original licensor to copy, distribute, link with or modify the Library subject to these terms and conditions. You may not impose any further restrictions on the recipients' exercise of the rights granted herein. You are not responsible for enforcing compliance by third parties with this License.

11. If, as a consequence of a court judgment or allegation of patent infringement or for any other reason (not limited to patent issues), conditions are imposed on you (whether by court order, agreement or otherwise) that contradict the conditions of this License, they do not excuse you from the conditions of this License. If you cannot distribute so as to satisfy simultaneously your obligations under this License and any other pertinent obligations, then as a consequence you may not distribute the Library at all. For example, if a patent license would not permit royalty-free redistribution of the Library by all those who receive copies directly or indirectly through you, then the only way you could satisfy both it and this License would be to refrain entirely from distribution of the Library.

If any portion of this section is held invalid or unenforceable under any particular circumstance, the balance of the section is intended to apply, and the section as a whole is intended to apply in other circumstances.

It is not the purpose of this section to induce you to infringe any patents or other property right claims or to contest validity of any such claims; this section has the sole purpose of protecting the integrity of the free software distribution system which is implemented by public license practices. Many people have made generous contributions to the wide range of software distributed through that system in reliance on consistent application of that system; it is up to the author/donor to decide if he or she is willing to distribute software through any other system and a licensee cannot impose that choice.

This section is intended to make thoroughly clear what is believed to be a consequence of the rest of this License.

12. If the distribution and/or use of the Library is restricted in certain countries either by patents or by copyrighted interfaces, the original copyright holder who places the Library under this License may add an explicit geographical distribution limitation excluding those countries, so that distribution is permitted only in or among countries not thus excluded. In such case, this License incorporates the limitation as if written in the body of this License.

13. The Free Software Foundation may publish revised and/or new versions of the Lesser General Public License from time to time. Such new versions will be similar in spirit to the present version, but may differ in detail to address new problems or concerns.

Each version is given a distinguishing version number. If the Library specifies a version number of this License which applies to it and "any later version", you have the option of following the terms and conditions either of that version or of any later version published by the Free Software Foundation. If the Library does not specify a license version number, you may choose any version ever published by the Free Software Foundation.

14. If you wish to incorporate parts of the Library into other free programs whose distribution conditions are incompatible with these, write to the author to ask for permission. For software which is copyrighted by the Free Software Foundation, write to the Free Software Foundation; we sometimes make exceptions for this. Our decision will be guided by the two goals of preserving the free status of all derivatives of our free software and of promoting the sharing and reuse of software generally.

NO WARRANTY

15. BECAUSE THE LIBRARY IS LICENSED FREE OF CHARGE, THERE IS NO WARRANTY FOR THE LIBRARY, TO THE EXTENT PERMITTED BY APPLICABLE LAW. EXCEPT WHEN OTHERWISE STATED IN WRITING THE COPYRIGHT HOLDERS AND/OR OTHER PARTIES PROVIDE THE LIBRARY "AS IS" WITHOUT WARRANTY OF ANY KIND, EITHER EXPRESSED OR IMPLIED, INCLUDING, BUT NOT LIMITED TO, THE IMPLIED WARRANTIES OF MERCHANTABILITY AND FITNESS FOR A PARTICULAR PURPOSE. THE ENTIRE RISK AS TO THE QUALITY AND

PERFORMANCE OF THE LIBRARY IS WITH YOU. SHOULD THE LIBRARY PROVE DEFECTIVE, YOU ASSUME THE COST OF ALL NECESSARY SERVICING, REPAIR OR CORRECTION.

16. IN NO EVENT UNLESS REQUIRED BY APPLICABLE LAW OR AGREED TO IN WRITING WILL ANY COPYRIGHT HOLDER, OR ANY OTHER PARTY WHO MAY MODIFY AND/OR REDISTRIBUTE THE LIBRARY AS PERMITTED ABOVE, BE LIABLE TO YOU FOR DAMAGES, INCLUDING ANY GENERAL, SPECIAL, INCIDENTAL OR CONSEQUENTIAL DAMAGES ARISING OUT OF THE USE OR INABILITY TO USE THE LIBRARY (INCLUDING BUT NOT LIMITED TO LOSS OF DATA OR DATA BEING RENDERED INACCURATE OR LOSSES SUSTAINED BY YOU OR THIRD PARTIES OR A FAILURE OF THE LIBRARY TO OPERATE WITH ANY OTHER SOFTWARE), EVEN IF SUCH HOLDER OR OTHER PARTY HAS BEEN ADVISED OF THE POSSIBILITY OF SUCH DAMAGES.

END OF TERMS AND CONDITIONS

How to Apply These Terms to Your New Libraries

If you develop a new library, and you want it to be of the greatest possible use to the public, we recommend making it free software that everyone can redistribute and change. You can do so by permitting redistribution under these terms (or, alternatively, under the terms of the ordinary General Public License).

To apply these terms, attach the following notices to the library. It is safest to attach them to the start of each source file to most effectively convey the exclusion of warranty; and each file should have at least the "copyright" line and a pointer to where the full notice is found.

<one line to give the library's name and a brief idea of what it does.>

Copyright (C) <year> <name of author>

This library is free software; you can redistribute it and/or modify it under the terms of the GNU Lesser General Public License as published by the Free Software Foundation; either version 2.1 of the License, or (at your option) any later version.

This library is distributed in the hope that it will be useful, but WITHOUT ANY WARRANTY; without even the implied warranty of MERCHANTABILITY or FITNESS FOR A PARTICULAR PURPOSE. See the GNU Lesser General Public License for more details.

You should have received a copy of the GNU Lesser General Public License along with this library; if not, write to the Free Software Foundation, Inc., 51 Franklin Street, Fifth Floor, Boston, MA 02110-1301 USA

Also add information on how to contact you by electronic and paper mail.

You should also get your employer (if you work as a programmer) or your school, if any, to sign a "copyright disclaimer" for the library, if necessary. Here is a sample; alter the names:

Yoyodyne, Inc., hereby disclaims all copyright interest in the library `Frob' (a library for tweaking knobs) written by James Random Hacker.

<signature of Ty Coon>, 1 April 1990

Ty Coon, President of Vice

That's all there is to it!

libjpeg

This projector product includes the open source software program "libjpeg" which applies the terms and conditions provided by owner of the copyright to the "libjpeg".

The "libjpeg" are WITHOUT ANY WARRANTY; without even the implied warranty of MERCHANTABILITY AND FITNESS FOR A PARTICULAR PURPOSE.

List of libjpeg programs

- libjpeg-6b

License terms of conditions of each program which are provided by owner of the copyright to the "libjpeg" are as follows.

Copyright (C) 1994-1997, Thomas G. Lane. This file is part of the Independent JPEG Group's software. For conditions of distribution and use, see the accompanying README file.

This distribution contains the sixth public release of the Independent JPEG Group's free JPEG software. You are welcome to redistribute this software and to use it for any purpose, subject to the conditions under LEGAL ISSUES, below.

LEGAL ISSUES

=====

In plain English:

1. We don't promise that this software works. (But if you find any bugs, please let us know!)
2. You can use this software for whatever you want. You don't have to pay us.
3. You may not pretend that you wrote this software. If you use it in a program, you must acknowledge somewhere in your documentation that you've used the IJG code.

In legalese:

The authors make NO WARRANTY or representation, either express or implied, with respect to this software, its quality, accuracy, merchantability, or fitness for a particular purpose. This software is provided "AS IS", and you, its user, assume the entire risk as to its quality and accuracy.

This software is copyright (C) 1991-1998, Thomas G. Lane. All Rights Reserved except as specified below.

Permission is hereby granted to use, copy, modify, and distribute this software (or portions thereof) for any purpose, without fee, subject to these conditions:

(1) If any part of the source code for this software is distributed, then this README file must be included, with this copyright and no-warranty notice unaltered; and any additions, deletions, or changes to the original files must be clearly indicated in accompanying documentation.

(2) If only executable code is distributed, then the accompanying documentation must state that "this software is based in part on the work of the Independent JPEG Group".

(3) Permission for use of this software is granted only if the user accepts full responsibility for any undesirable consequences; the authors accept NO LIABILITY for damages of any kind.

These conditions apply to any software derived from or based on the IJG code, not just to the unmodified library. If you use our work, you ought to acknowledge us.

Permission is NOT granted for the use of any IJG author's name or company name in advertising or publicity relating to this software or products derived from it. This software may be referred to only as "the Independent JPEG Group's software".

We specifically permit and encourage the use of this software as the basis of commercial products, provided that all warranty or liability claims are assumed by the product vendor.

ansi2knr.c is included in this distribution by permission of L. Peter Deutsch, sole proprietor of its copyright holder, Aladdin Enterprises of Menlo Park, CA. ansi2knr.c is NOT covered by the above copyright and conditions, but instead by the usual distribution terms of the Free Software Foundation; principally, that you must include source code if you redistribute it. (See the file ansi2knr.c for full details.) However, since ansi2knr.c is not needed as part of any program generated from the IJG code, this does not limit you more than the foregoing paragraphs do.

The Unix configuration script "configure" was produced with GNU Autoconf. It is copyright by the Free Software Foundation but is freely distributable. The same holds for its supporting scripts (config.guess, config.sub, ltconfig, ltmain.sh). Another support script, install-sh, is copyright by M.I.T. but is also freely distributable.

It appears that the arithmetic coding option of the JPEG spec is covered by patents owned by IBM, AT&T, and Mitsubishi. Hence arithmetic coding cannot legally be used without obtaining one or more licenses. For this reason, support for arithmetic coding has been removed from the free JPEG software. (Since arithmetic coding provides only a marginal gain over the unpatented Huffman mode, it is unlikely that very many implementations will support it.) So far as we are aware, there are no patent restrictions on the remaining code.

The IJG distribution formerly included code to read and write GIF files. To avoid entanglement with the Unisys LZW patent, GIF reading support has been removed altogether, and the GIF writer has been

simplified to produce "uncompressed GIFs". This technique does not use the LZW algorithm; the resulting GIF files are larger than usual, but are readable by all standard GIF decoders.

We are required to state that "The Graphics Interchange Format(c) is the Copyright property of CompuServe Incorporated. GIF(sm) is a Service Mark property of CompuServe Incorporated."

libpng

This projector product includes the open source software program "libpng" which applies the terms and conditions provided by owner of the copyright to the "libpng".

The "libpng" are WITHOUT ANY WARRANTY; without even the implied warranty of MERCHANTABILITY AND FITNESS FOR A PARTICULAR PURPOSE.

List of libpng programs

- libpng-1.2.49

License terms of conditions of each program which are provided by owner of the copyright to the "libpng" are as follows.

This copy of the libpng notices is provided for your convenience. In case of any discrepancy between this copy and the notices in the file png.h that is included in the libpng distribution, the latter shall prevail.

COPYRIGHT NOTICE, DISCLAIMER, and LICENSE:

If you modify libpng you may insert additional notices immediately following this sentence.

This code is released under the libpng license.

libpng versions 1.2.6, August 15, 2004, through 1.2.49, March 29, 2012, are Copyright (c) 2004, 2006-2009 Glenn Randers-Pehrson, and are distributed according to the same disclaimer and license as libpng-1.2.5 with the following individual added to the list of Contributing Authors

Cosmin Truta

libpng versions 1.0.7, July 1, 2000, through 1.2.5 - October 3, 2002, are Copyright (c) 2000-2002 Glenn Randers-Pehrson, and are distributed according to the same disclaimer and license as libpng-1.0.6 with the following individuals added to the list of Contributing Authors

Simon-Pierre Cadieux

Eric S. Raymond

Gilles Vollant

and with the following additions to the disclaimer:

There is no warranty against interference with your enjoyment of the library or against infringement. There is no warranty that our efforts or the library will fulfill any of your particular purposes or needs. This

library is provided with all faults, and the entire risk of satisfactory quality, performance, accuracy, and effort is with the user.

libpng versions 0.97, January 1998, through 1.0.6, March 20, 2000, are Copyright (c) 1998, 1999 Glenn Randers-Pehrson, and are distributed according to the same disclaimer and license as libpng-0.96, with the following individuals added to the list of Contributing Authors:

Tom Lane

Glenn Randers-Pehrson

Willem van Schaik

libpng versions 0.89, June 1996, through 0.96, May 1997, are Copyright (c) 1996, 1997 Andreas Dilger Distributed according to the same disclaimer and license as libpng-0.88, with the following individuals added to the list of Contributing Authors:

John Bowler

Kevin Bracey

Sam Bushell

Magnus Holmgren

Greg Roelofs

Tom Tanner

libpng versions 0.5, May 1995, through 0.88, January 1996, are Copyright (c) 1995, 1996 Guy Eric Schalnat, Group 42, Inc.

For the purposes of this copyright and license, "Contributing Authors" is defined as the following set of individuals:

Andreas Dilger

Dave Martindale

Guy Eric Schalnat

Paul Schmidt

Tim Wegner

The PNG Reference Library is supplied "AS IS". The Contributing Authors and Group 42, Inc. disclaim all warranties, expressed or implied, including, without limitation, the warranties of merchantability and of fitness for any purpose. The Contributing Authors and Group 42, Inc. assume no liability for direct, indirect, incidental, special, exemplary, or consequential damages, which may result from the use of the PNG Reference Library, even if advised of the possibility of such damage.

Permission is hereby granted to use, copy, modify, and distribute this source code, or portions hereof, for any purpose, without fee, subject to the following restrictions:

1. The origin of this source code must not be misrepresented.
2. Altered versions must be plainly marked as such and must not be misrepresented as being the original source.
3. This Copyright notice may not be removed or altered from any source or altered source distribution.

The Contributing Authors and Group 42, Inc. specifically permit, without fee, and encourage the use of this source code as a component to supporting the PNG file format in commercial products. If you use this source code in a product, acknowledgment is not required but would be appreciated.

A "png_get_copyright" function is available, for convenient use in "about" boxes and the like:

```
printf("%s",png_get_copyright(NULL));
```

Also, the PNG logo (in PNG format, of course) is supplied in the files "pngbar.png" and "pngbar.jpg" (88x31) and "pngnow.png" (98x31).

Libpng is OSI Certified Open Source Software. OSI Certified Open Source is a certification mark of the Open Source Initiative.

Glenn Randers-Pehrson

glennrp at users.sourceforge.net

March 29, 2012

zlib

This projector product includes the open source software program "zlib" which applies the terms and conditions provided by owner of the copyright to the "zlib".

The "zlib" are WITHOUT ANY WARRANTY; without even the implied warranty of MERCHANTABILITY AND FITNESS FOR A PARTICULAR PURPOSE.

List of zlib programs

- zlib-1.1.4

License terms of conditions of each program which are provided by owner of the copyright to the "zlib" are as follows.

Copyright notice:

(C) 1995-1998 Jean-loup Gailly and Mark Adler

This software is provided 'as-is', without any express or implied warranty. In no event will the authors be held liable for any damages arising from the use of this software.

Permission is granted to anyone to use this software for any purpose, including commercial applications, and to alter it and redistribute it freely, subject to the following restrictions:

1. The origin of this software must not be misrepresented; you must not claim that you wrote the original software. If you use this software in a product, an acknowledgment in the product documentation would be appreciated but is not required.
2. Altered source versions must be plainly marked as such, and must not be misrepresented as being the original software.
3. This notice may not be removed or altered from any source distribution.

Jean-loup Gailly

jloup@gzip.org

Mark Adler

madler@alumni.caltech.edu

If you use the zlib library in a product, we would appreciate *not* receiving lengthy legal documents to sign. The sources are provided for free but without warranty of any kind. The library has been entirely written by Jean-loup Gailly and Mark Adler; it does not include third-party code.

If you redistribute modified sources, we would appreciate that you include in the file ChangeLog history information documenting your changes.

aes-src-29-04-09

This projector product includes the open source software program "aes-src-29-04-09" which applies the terms and conditions provided by owner of the copyright to the "aes-src-29-04-09".

The "aes-src-29-04-09" are WITHOUT ANY WARRANTY; without even the implied warranty of MERCHANTABILITY AND FITNESS FOR A PARTICULAR PURPOSE.

List of aes-src-29-04-09 programs

- aes-src-29-04-09

License terms of conditions of each program which are provided by owner of the copyright to the "aes-src-29-04-09" are as follows.

Copyright (c) 1998-2008, Brian Gladman, Worcester, UK. All rights reserved.

LICENSE TERMS

The redistribution and use of this software (with or without changes) is allowed without the payment of fees or royalties provided that:

1. source code distributions include the above copyright notice, this list of conditions and the following disclaimer;

2. binary distributions include the above copyright notice, this list of conditions and the following disclaimer in their documentation;

3. the name of the copyright holder is not used to endorse products built using this software without specific written permission.

DISCLAIMER

This software is provided 'as is' with no explicit or implied warranties in respect of its properties, including, but not limited to, correctness and/or fitness for purpose.

newlib

This projector product includes the open source software program "newlib" which applies the terms and conditions provided by owner of the copyright to the "newlib".

The "newlib" are WITHOUT ANY WARRANTY; without even the implied warranty of MERCHANTABILITY AND FITNESS FOR A PARTICULAR PURPOSE.

List of newlib programs

- newlib 1.17.0

License terms of conditions of each program which are provided by owner of the copyright to the "newlib" are as follows.

The newlib subdirectory is a collection of software from several sources.

Each file may have its own copyright/license that is embedded in the source file. Unless otherwise noted in the body of the source file(s), the following copyright notices will apply to the contents of the newlib subdirectory:

(1) Red Hat Incorporated

Copyright (c) 1994-2007 Red Hat, Inc. All rights reserved.

This copyrighted material is made available to anyone wishing to use, modify, copy, or redistribute it subject to the terms and conditions of the BSD License. This program is distributed in the hope that it will be useful, but WITHOUT ANY WARRANTY expressed or implied, including the implied warranties of MERCHANTABILITY or FITNESS FOR A PARTICULAR PURPOSE. A copy of this license is available at <http://www.opensource.org/licenses>. Any Red Hat trademarks that are incorporated in the source code or documentation are not subject to the BSD License and may only be used or replicated with the express permission of Red Hat, Inc.

(2) University of California, Berkeley

Copyright (c) 1981-2000 The Regents of the University of California.

All rights reserved.

Redistribution and use in source and binary forms, with or without modification, are permitted provided that the following conditions are met:

* Redistributions of source code must retain the above copyright notice, this list of conditions and the following disclaimer.

* Redistributions in binary form must reproduce the above copyright notice, this list of conditions and the following disclaimer in the documentation and/or other materials provided with the distribution.

* Neither the name of the University nor the names of its contributors may be used to endorse or promote products derived from this software without specific prior written permission.

THIS SOFTWARE IS PROVIDED BY THE COPYRIGHT HOLDERS AND CONTRIBUTORS "AS IS" AND ANY EXPRESS OR IMPLIED WARRANTIES, INCLUDING, BUT NOT LIMITED TO, THE IMPLIED WARRANTIES OF MERCHANTABILITY AND FITNESS FOR A PARTICULAR PURPOSE ARE DISCLAIMED. IN NO EVENT SHALL THE COPYRIGHT OWNER OR CONTRIBUTORS BE LIABLE FOR ANY DIRECT, INDIRECT, INCIDENTAL, SPECIAL, EXEMPLARY, OR CONSEQUENTIAL DAMAGES (INCLUDING, BUT NOT LIMITED TO, PROCUREMENT OF SUBSTITUTE GOODS OR SERVICES; LOSS OF USE, DATA, OR PROFITS; OR BUSINESS INTERRUPTION) HOWEVER CAUSED AND ON ANY THEORY OF LIABILITY, WHETHER IN CONTRACT, STRICT LIABILITY, OR TORT (INCLUDING NEGLIGENCE OR OTHERWISE) ARISING IN ANY WAY OUT OF THE USE OF THIS SOFTWARE, EVEN IF ADVISED OF THE POSSIBILITY OF SUCH DAMAGE.

(3) David M. Gay (AT&T 1991, Lucent 1998)

The author of this software is David M. Gay.

Copyright (c) 1991 by AT&T.

Permission to use, copy, modify, and distribute this software for any purpose without fee is hereby granted, provided that this entire notice is included in all copies of any software which is or includes a copy or modification of this software and in all copies of the supporting documentation for such software.

THIS SOFTWARE IS BEING PROVIDED "AS IS", WITHOUT ANY EXPRESS OR IMPLIED WARRANTY. IN PARTICULAR, NEITHER THE AUTHOR NOR AT&T MAKES ANY REPRESENTATION OR WARRANTY OF ANY KIND CONCERNING THE MERCHANTABILITY OF THIS SOFTWARE OR ITS FITNESS FOR ANY PARTICULAR PURPOSE.

The author of this software is David M. Gay.

Copyright (C) 1998-2001 by Lucent Technologies

All Rights Reserved

Permission to use, copy, modify, and distribute this software and its documentation for any purpose and without fee is hereby granted, provided that the above copyright notice appear in all copies and that both

that the copyright notice and this permission notice and warranty disclaimer appear in supporting documentation, and that the name of Lucent or any of its entities not be used in advertising or publicity pertaining to distribution of the software without specific, written prior permission.

LUCENT DISCLAIMS ALL WARRANTIES WITH REGARD TO THIS SOFTWARE, INCLUDING ALL IMPLIED WARRANTIES OF MERCHANTABILITY AND FITNESS. IN NO EVENT SHALL LUCENT OR ANY OF ITS ENTITIES BE LIABLE FOR ANY SPECIAL, INDIRECT OR CONSEQUENTIAL DAMAGES OR ANY DAMAGES WHATSOEVER RESULTING FROM LOSS OF USE, DATA OR PROFITS, WHETHER IN AN ACTION OF CONTRACT, NEGLIGENCE OR OTHER TORTIOUS ACTION, ARISING OUT OF OR IN CONNECTION WITH THE USE OR PERFORMANCE OF THIS SOFTWARE.

(4) Advanced Micro Devices

Copyright 1989, 1990 Advanced Micro Devices, Inc.

This software is the property of Advanced Micro Devices, Inc (AMD) which specifically grants the user the right to modify, use and distribute this software provided this notice is not removed or altered. All other rights are reserved by AMD.

AMD MAKES NO WARRANTY OF ANY KIND, EXPRESS OR IMPLIED, WITH REGARD TO THIS SOFTWARE. IN NO EVENT SHALL AMD BE LIABLE FOR INCIDENTAL OR CONSEQUENTIAL DAMAGES IN CONNECTION WITH OR ARISING FROM THE FURNISHING, PERFORMANCE, OR USE OF THIS SOFTWARE.

So that all may benefit from your experience, please report any problems or suggestions about this software to the 29K Technical Support Center at 800-29-29-AMD (800-292-9263) in the USA, or 0800-89-1131 in the UK, or 0031-11-1129 in Japan, toll free. The direct dial number is 512-462-4118.

Advanced Micro Devices, Inc.

29K Support Products

Mail Stop 573

5900 E. Ben White Blvd.

Austin, TX 78741

800-292-9263

(5) C.W. Sandmann

Copyright (C) 1993 C.W. Sandmann

This file may be freely distributed as long as the author's name remains.

(6) Eric Backus

(C) Copyright 1992 Eric Backus

This software may be used freely so long as this copyright notice is left intact. There is no warrantee on this software.

(7) Sun Microsystems

Copyright (C) 1993 by Sun Microsystems, Inc. All rights reserved.

Developed at SunPro, a Sun Microsystems, Inc. business. Permission to use, copy, modify, and distribute this software is freely granted, provided that this notice is preserved.

(8) Hewlett Packard

(c) Copyright 1986 HEWLETT-PACKARD COMPANY

To anyone who acknowledges that this file is provided "AS IS" without any express or implied warranty: permission to use, copy, modify, and distribute this file for any purpose is hereby granted without fee, provided that the above copyright notice and this notice appears in all copies, and that the name of Hewlett-Packard Company not be used in advertising or publicity pertaining to distribution of the software without specific, written prior permission. Hewlett-Packard Company makes no representations about the suitability of this software for any purpose.

(9) Hans-Peter Nilsson

Copyright (C) 2001 Hans-Peter Nilsson

Permission to use, copy, modify, and distribute this software is freely granted, provided that the above copyright notice, this notice and the following disclaimer are preserved with no changes.

THIS SOFTWARE IS PROVIDED "AS IS" AND WITHOUT ANY EXPRESS OR IMPLIED WARRANTIES, INCLUDING, WITHOUT LIMITATION, THE IMPLIED WARRANTIES OF MERCHANTABILITY AND FITNESS FOR A PARTICULAR PURPOSE.

(11) Christopher G. Demetriou

Copyright (c) 2001 Christopher G. Demetriou

All rights reserved.

Redistribution and use in source and binary forms, with or without modification, are permitted provided that the following conditions are met:

1. Redistributions of source code must retain the above copyright notice, this list of conditions and the following disclaimer.
2. Redistributions in binary form must reproduce the above copyright notice, this list of conditions and the following disclaimer in the documentation and/or other materials provided with the distribution.
3. The name of the author may not be used to endorse or promote products derived from this software without specific prior written permission.

THIS SOFTWARE IS PROVIDED BY THE AUTHOR "AS IS" AND ANY EXPRESS OR IMPLIED WARRANTIES, INCLUDING, BUT NOT LIMITED TO, THE IMPLIED WARRANTIES OF MERCHANTABILITY AND FITNESS FOR A PARTICULAR PURPOSE ARE DISCLAIMED. IN NO EVENT SHALL THE AUTHOR BE LIABLE FOR ANY DIRECT, INDIRECT, INCIDENTAL, SPECIAL, EXEMPLARY, OR CONSEQUENTIAL DAMAGES (INCLUDING, BUT NOT LIMITED TO, PROCUREMENT OF SUBSTITUTE GOODS OR SERVICES; LOSS OF USE, DATA, OR PROFITS; OR BUSINESS INTERRUPTION) HOWEVER CAUSED AND ON ANY THEORY OF LIABILITY, WHETHER IN CONTRACT, STRICT LIABILITY, OR TORT (INCLUDING NEGLIGENCE OR OTHERWISE) ARISING IN ANY WAY OUT OF THE USE OF THIS SOFTWARE, EVEN IF ADVISED OF THE POSSIBILITY OF SUCH DAMAGE.

(12) SuperH, Inc.

Copyright 2002 SuperH, Inc. All rights reserved

This software is the property of SuperH, Inc (SuperH) which specifically grants the user the right to modify, use and distribute this software provided this notice is not removed or altered. All other rights are reserved by SuperH.

SUPERH MAKES NO WARRANTY OF ANY KIND, EXPRESS OR IMPLIED, WITH REGARD TO THIS SOFTWARE. IN NO EVENT SHALL SUPERH BE LIABLE FOR INDIRECT, SPECIAL, INCIDENTAL OR CONSEQUENTIAL DAMAGES IN CONNECTION WITH OR ARISING FROM THE FURNISHING, PERFORMANCE, OR USE OF THIS SOFTWARE.

So that all may benefit from your experience, please report any problems or suggestions about this software to the SuperH Support Center via e-mail at softwaresupport@superh.com.

SuperH, Inc.

405 River Oaks Parkway

San Jose

CA 95134

USA

(13) Royal Institute of Technology

Copyright (c) 1999 Kungliga Tekniska Högskolan (Royal Institute of Technology, Stockholm, Sweden).

All rights reserved.

Redistribution and use in source and binary forms, with or without modification, are permitted provided that the following conditions are met:

1. Redistributions of source code must retain the above copyright notice, this list of conditions and the following disclaimer.

2. Redistributions in binary form must reproduce the above copyright notice, this list of conditions and the following disclaimer in the documentation and/or other materials provided with the distribution.

3. Neither the name of KTH nor the names of its contributors may be used to endorse or promote products derived from this software without specific prior written permission.

THIS SOFTWARE IS PROVIDED BY KTH AND ITS CONTRIBUTORS "AS IS" AND ANY EXPRESS OR IMPLIED WARRANTIES, INCLUDING, BUT NOT LIMITED TO, THE IMPLIED WARRANTIES OF MERCHANTABILITY AND FITNESS FOR A PARTICULAR PURPOSE ARE DISCLAIMED. IN NO EVENT SHALL KTH OR ITS CONTRIBUTORS BE LIABLE FOR ANY DIRECT, INDIRECT, INCIDENTAL, SPECIAL, EXEMPLARY, OR CONSEQUENTIAL DAMAGES (INCLUDING, BUT NOT LIMITED TO, PROCUREMENT OF SUBSTITUTE GOODS OR SERVICES; LOSS OF USE, DATA, OR PROFITS; OR BUSINESS INTERRUPTION) HOWEVER CAUSED AND ON ANY THEORY OF LIABILITY, WHETHER IN CONTRACT, STRICT LIABILITY, OR TORT (INCLUDING NEGLIGENCE OR OTHERWISE) ARISING IN ANY WAY OUT OF THE USE OF THIS SOFTWARE, EVEN IF ADVISED OF THE POSSIBILITY OF SUCH DAMAGE.

(14) Alexey Zelkin

Copyright (c) 2000, 2001 Alexey Zelkin <phantom@FreeBSD.org>

All rights reserved.

Redistribution and use in source and binary forms, with or without modification, are permitted provided that the following conditions are met:

1. Redistributions of source code must retain the above copyright notice, this list of conditions and the following disclaimer.

2. Redistributions in binary form must reproduce the above copyright notice, this list of conditions and the following disclaimer in the documentation and/or other materials provided with the distribution.

THIS SOFTWARE IS PROVIDED BY THE AUTHOR AND CONTRIBUTORS "AS IS" AND ANY EXPRESS OR IMPLIED WARRANTIES, INCLUDING, BUT NOT LIMITED TO, THE IMPLIED WARRANTIES OF MERCHANTABILITY AND FITNESS FOR A PARTICULAR PURPOSE ARE DISCLAIMED. IN NO EVENT SHALL THE AUTHOR OR CONTRIBUTORS BE LIABLE FOR ANY DIRECT, INDIRECT, INCIDENTAL, SPECIAL, EXEMPLARY, OR CONSEQUENTIAL DAMAGES (INCLUDING, BUT NOT LIMITED TO, PROCUREMENT OF SUBSTITUTE GOODS OR SERVICES; LOSS OF USE, DATA, OR PROFITS; OR BUSINESS INTERRUPTION) HOWEVER CAUSED AND ON ANY THEORY OF LIABILITY, WHETHER IN CONTRACT, STRICT LIABILITY, OR TORT (INCLUDING NEGLIGENCE OR OTHERWISE) ARISING IN ANY WAY OUT OF THE USE OF THIS SOFTWARE, EVEN IF ADVISED OF THE POSSIBILITY OF SUCH DAMAGE.

(15) Andrey A. Chernov

Copyright (C) 1997 by Andrey A. Chernov, Moscow, Russia.

All rights reserved.

Redistribution and use in source and binary forms, with or without modification, are permitted provided that the following conditions are met:

1. Redistributions of source code must retain the above copyright notice, this list of conditions and the following disclaimer.
2. Redistributions in binary form must reproduce the above copyright notice, this list of conditions and the following disclaimer in the documentation and/or other materials provided with the distribution.

THIS SOFTWARE IS PROVIDED BY THE AUTHOR "AS IS" AND ANY EXPRESS OR IMPLIED WARRANTIES, INCLUDING, BUT NOT LIMITED TO, THE IMPLIED WARRANTIES OF MERCHANTABILITY AND FITNESS FOR A PARTICULAR PURPOSE ARE DISCLAIMED. IN NO EVENT SHALL THE REGENTS OR CONTRIBUTORS BE LIABLE FOR ANY DIRECT, INDIRECT, INCIDENTAL, SPECIAL, EXEMPLARY, OR CONSEQUENTIAL DAMAGES (INCLUDING, BUT NOT LIMITED TO, PROCUREMENT OF SUBSTITUTE GOODS OR SERVICES; LOSS OF USE, DATA, OR PROFITS; OR BUSINESS INTERRUPTION) HOWEVER CAUSED AND ON ANY THEORY OF LIABILITY, WHETHER IN CONTRACT, STRICT LIABILITY, OR TORT (INCLUDING NEGLIGENCE OR OTHERWISE) ARISING IN ANY WAY OUT OF THE USE OF THIS SOFTWARE, EVEN IF ADVISED OF THE POSSIBILITY OF SUCH DAMAGE.

(16) FreeBSD

Copyright (c) 1997-2002 FreeBSD Project.

All rights reserved.

Redistribution and use in source and binary forms, with or without modification, are permitted provided that the following conditions are met:

1. Redistributions of source code must retain the above copyright notice, this list of conditions and the following disclaimer.
2. Redistributions in binary form must reproduce the above copyright notice, this list of conditions and the following disclaimer in the documentation and/or other materials provided with the distribution.

THIS SOFTWARE IS PROVIDED BY THE AUTHOR AND CONTRIBUTORS "AS IS" AND ANY EXPRESS OR IMPLIED WARRANTIES, INCLUDING, BUT NOT LIMITED TO, THE IMPLIED WARRANTIES OF MERCHANTABILITY AND FITNESS FOR A PARTICULAR PURPOSE ARE DISCLAIMED. IN NO EVENT SHALL THE AUTHOR OR CONTRIBUTORS BE LIABLE FOR ANY DIRECT, INDIRECT, INCIDENTAL, SPECIAL, EXEMPLARY, OR CONSEQUENTIAL DAMAGES (INCLUDING, BUT NOT LIMITED TO, PROCUREMENT OF SUBSTITUTE GOODS OR SERVICES; LOSS OF USE, DATA, OR PROFITS; OR BUSINESS INTERRUPTION) HOWEVER CAUSED AND ON ANY THEORY OF LIABILITY, WHETHER IN CONTRACT, STRICT LIABILITY, OR TORT (INCLUDING NEGLIGENCE OR OTHERWISE) ARISING IN ANY WAY OUT OF THE USE OF THIS SOFTWARE, EVEN IF ADVISED OF THE POSSIBILITY OF SUCH DAMAGE.

(17) S. L. Moshier

Author: S. L. Moshier.

Copyright (c) 1984,2000 S.L. Moshier

Permission to use, copy, modify, and distribute this software for any purpose without fee is hereby granted, provided that this entire notice is included in all copies of any software which is or includes a copy or modification of this software and in all copies of the supporting documentation for such software.

THIS SOFTWARE IS BEING PROVIDED "AS IS", WITHOUT ANY EXPRESS OR IMPLIED WARRANTY. IN PARTICULAR, THE AUTHOR MAKES NO REPRESENTATION OR WARRANTY OF ANY KIND CONCERNING THE MERCHANTABILITY OF THIS SOFTWARE OR ITS FITNESS FOR ANY PARTICULAR PURPOSE.

(18) Citrus Project

Copyright (c)1999 Citrus Project,

All rights reserved.

Redistribution and use in source and binary forms, with or without modification, are permitted provided that the following conditions are met:

1. Redistributions of source code must retain the above copyright notice, this list of conditions and the following disclaimer.
2. Redistributions in binary form must reproduce the above copyright notice, this list of conditions and the following disclaimer in the documentation and/or other materials provided with the distribution.

THIS SOFTWARE IS PROVIDED BY THE AUTHOR AND CONTRIBUTORS "AS IS" AND ANY EXPRESS OR IMPLIED WARRANTIES, INCLUDING, BUT NOT LIMITED TO, THE IMPLIED WARRANTIES OF MERCHANTABILITY AND FITNESS FOR A PARTICULAR PURPOSE ARE DISCLAIMED. IN NO EVENT SHALL THE AUTHOR OR CONTRIBUTORS BE LIABLE FOR ANY DIRECT, INDIRECT, INCIDENTAL, SPECIAL, EXEMPLARY, OR CONSEQUENTIAL DAMAGES (INCLUDING, BUT NOT LIMITED TO, PROCUREMENT OF SUBSTITUTE GOODS OR SERVICES; LOSS OF USE, DATA, OR PROFITS; OR BUSINESS INTERRUPTION) HOWEVER CAUSED AND ON ANY THEORY OF LIABILITY, WHETHER IN CONTRACT, STRICT LIABILITY, OR TORT (INCLUDING NEGLIGENCE OR OTHERWISE) ARISING IN ANY WAY OUT OF THE USE OF THIS SOFTWARE, EVEN IF ADVISED OF THE POSSIBILITY OF SUCH DAMAGE.

(19) Todd C. Miller

Copyright (c) 1998 Todd C. Miller <Todd.Miller@courtesan.com>

All rights reserved.

Redistribution and use in source and binary forms, with or without modification, are permitted provided that the following conditions are met:

1. Redistributions of source code must retain the above copyright notice, this list of conditions and the following disclaimer.
2. Redistributions in binary form must reproduce the above copyright notice, this list of conditions and the following disclaimer in the documentation and/or other materials provided with the distribution.
3. The name of the author may not be used to endorse or promote products derived from this software without specific prior written permission.

THIS SOFTWARE IS PROVIDED "AS IS" AND ANY EXPRESS OR IMPLIED WARRANTIES, INCLUDING, BUT NOT LIMITED TO, THE IMPLIED WARRANTIES OF MERCHANTABILITY AND FITNESS FOR A PARTICULAR PURPOSE ARE DISCLAIMED. IN NO EVENT SHALL THE AUTHOR BE LIABLE FOR ANY DIRECT, INDIRECT, INCIDENTAL, SPECIAL, EXEMPLARY, OR CONSEQUENTIAL DAMAGES (INCLUDING, BUT NOT LIMITED TO, PROCUREMENT OF SUBSTITUTE GOODS OR SERVICES; LOSS OF USE, DATA, OR PROFITS; OR BUSINESS INTERRUPTION) HOWEVER CAUSED AND ON ANY THEORY OF LIABILITY, WHETHER IN CONTRACT, STRICT LIABILITY, OR TORT (INCLUDING NEGLIGENCE OR OTHERWISE) ARISING IN ANY WAY OUT OF THE USE OF THIS SOFTWARE, EVEN IF ADVISED OF THE POSSIBILITY OF SUCH DAMAGE.

(20) DJ Delorie (i386)

Copyright (C) 1991 DJ Delorie

All rights reserved.

Redistribution and use in source and binary forms is permitted provided that the above copyright notice and following paragraph are duplicated in all such forms.

This file is distributed WITHOUT ANY WARRANTY; without even the implied warranty of MERCHANTABILITY or FITNESS FOR A PARTICULAR PURPOSE.

(23) Intel (i960)

Copyright (c) 1993 Intel Corporation

Intel hereby grants you permission to copy, modify, and distribute this software and its documentation. Intel grants this permission provided that the above copyright notice appears in all copies and that both the copyright notice and this permission notice appear in supporting documentation. In addition, Intel grants this permission provided that you prominently mark as "not part of the original" any modifications made to this software or documentation, and that the name of Intel Corporation not be used in advertising or publicity pertaining to distribution of the software or the documentation without specific, written prior permission.

Intel Corporation provides this AS IS, WITHOUT ANY WARRANTY, EXPRESS OR IMPLIED, INCLUDING, WITHOUT LIMITATION, ANY WARRANTY OF MERCHANTABILITY OR FITNESS FOR A PARTICULAR PURPOSE. Intel makes no guarantee or representations regarding the use of, or the

results of the use of, the software and documentation in terms of correctness, accuracy, reliability, currentness, or otherwise; and you rely on the software, documentation and results solely at your own risk.

IN NO EVENT SHALL INTEL BE LIABLE FOR ANY LOSS OF USE, LOSS OF BUSINESS, LOSS OF PROFITS, INDIRECT, INCIDENTAL, SPECIAL OR CONSEQUENTIAL DAMAGES OF ANY KIND. IN NO EVENT SHALL INTEL'S TOTAL LIABILITY EXCEED THE SUM PAID TO INTEL FOR THE PRODUCT LICENSED HEREUNDER.

(26) Mike Barcroft

Copyright (c) 2001 Mike Barcroft <mike@FreeBSD.org>

All rights reserved.

Redistribution and use in source and binary forms, with or without modification, are permitted provided that the following conditions are met:

1. Redistributions of source code must retain the above copyright notice, this list of conditions and the following disclaimer.
2. Redistributions in binary form must reproduce the above copyright notice, this list of conditions and the following disclaimer in the documentation and/or other materials provided with the distribution.

THIS SOFTWARE IS PROVIDED BY THE AUTHOR AND CONTRIBUTORS "AS IS" AND ANY EXPRESS OR IMPLIED WARRANTIES, INCLUDING, BUT NOT LIMITED TO, THE IMPLIED WARRANTIES OF MERCHANTABILITY AND FITNESS FOR A PARTICULAR PURPOSE ARE DISCLAIMED. IN NO EVENT SHALL THE AUTHOR OR CONTRIBUTORS BE LIABLE FOR ANY DIRECT, INDIRECT, INCIDENTAL, SPECIAL, EXEMPLARY, OR CONSEQUENTIAL DAMAGES (INCLUDING, BUT NOT LIMITED TO, PROCUREMENT OF SUBSTITUTE GOODS OR SERVICES; LOSS OF USE, DATA, OR PROFITS; OR BUSINESS INTERRUPTION) HOWEVER CAUSED AND ON ANY THEORY OF LIABILITY, WHETHER IN CONTRACT, STRICT LIABILITY, OR TORT (INCLUDING NEGLIGENCE OR OTHERWISE) ARISING IN ANY WAY OUT OF THE USE OF THIS SOFTWARE, EVEN IF ADVISED OF THE POSSIBILITY OF SUCH DAMAGE.

(27) Konstantin Chuguev (--enable-newlib-iconv)

Copyright (c) 1999, 2000

Konstantin Chuguev. All rights reserved.

Redistribution and use in source and binary forms, with or without modification, are permitted provided that the following conditions are met:

1. Redistributions of source code must retain the above copyright notice, this list of conditions and the following disclaimer.

2. Redistributions in binary form must reproduce the above copyright notice, this list of conditions and the following disclaimer in the documentation and/or other materials provided with the distribution.

THIS SOFTWARE IS PROVIDED BY THE AUTHOR AND CONTRIBUTORS "AS IS" AND ANY EXPRESS OR IMPLIED WARRANTIES, INCLUDING, BUT NOT LIMITED TO, THE IMPLIED WARRANTIES OF MERCHANTABILITY AND FITNESS FOR A PARTICULAR PURPOSE ARE DISCLAIMED. IN NO EVENT SHALL THE AUTHOR OR CONTRIBUTORS BE LIABLE FOR ANY DIRECT, INDIRECT, INCIDENTAL, SPECIAL, EXEMPLARY, OR CONSEQUENTIAL DAMAGES (INCLUDING, BUT NOT LIMITED TO, PROCUREMENT OF SUBSTITUTE GOODS OR SERVICES; LOSS OF USE, DATA, OR PROFITS; OR BUSINESS INTERRUPTION) HOWEVER CAUSED AND ON ANY THEORY OF LIABILITY, WHETHER IN CONTRACT, STRICT LIABILITY, OR TORT (INCLUDING NEGLIGENCE OR OTHERWISE) ARISING IN ANY WAY OUT OF THE USE OF THIS SOFTWARE, EVEN IF ADVISED OF THE POSSIBILITY OF SUCH DAMAGE.

iconv (Charset Conversion Library) v2.0

(28) Artem Bityuckiy (--enable-newlib-iconv)

Copyright (c) 2003, Artem B. Bityuckiy, SoftMine Corporation. Rights transferred to Franklin Electronic Publishers.

Redistribution and use in source and binary forms, with or without modification, are permitted provided that the following conditions are met:

1. Redistributions of source code must retain the above copyright notice, this list of conditions and the following disclaimer.

2. Redistributions in binary form must reproduce the above copyright notice, this list of conditions and the following disclaimer in the documentation and/or other materials provided with the distribution.

THIS SOFTWARE IS PROVIDED BY THE AUTHOR AND CONTRIBUTORS "AS IS" AND ANY EXPRESS OR IMPLIED WARRANTIES, INCLUDING, BUT NOT LIMITED TO, THE IMPLIED WARRANTIES OF MERCHANTABILITY AND FITNESS FOR A PARTICULAR PURPOSE ARE DISCLAIMED. IN NO EVENT SHALL THE AUTHOR OR CONTRIBUTORS BE LIABLE FOR ANY DIRECT, INDIRECT, INCIDENTAL, SPECIAL, EXEMPLARY, OR CONSEQUENTIAL DAMAGES (INCLUDING, BUT NOT LIMITED TO, PROCUREMENT OF SUBSTITUTE GOODS OR SERVICES; LOSS OF USE, DATA, OR PROFITS; OR BUSINESS INTERRUPTION) HOWEVER CAUSED AND ON ANY THEORY OF LIABILITY, WHETHER IN CONTRACT, STRICT LIABILITY, OR TORT (INCLUDING NEGLIGENCE OR OTHERWISE) ARISING IN ANY WAY OUT OF THE USE OF THIS SOFTWARE, EVEN IF ADVISED OF THE POSSIBILITY OF SUCH DAMAGE.

(30) - Alex Tatmanjants (targets using libc/posix)

Copyright (c) 1995 Alex Tatmanjants <alex@elvisti.kiev.ua>

at Electronni Visti IA, Kiev, Ukraine.

All rights reserved.

Redistribution and use in source and binary forms, with or without modification, are permitted provided that the following conditions are met:

1. Redistributions of source code must retain the above copyright notice, this list of conditions and the following disclaimer.
2. Redistributions in binary form must reproduce the above copyright notice, this list of conditions and the following disclaimer in the documentation and/or other materials provided with the distribution.

THIS SOFTWARE IS PROVIDED BY THE AUTHOR "AS IS" AND ANY EXPRESS OR IMPLIED WARRANTIES, INCLUDING, BUT NOT LIMITED TO, THE IMPLIED WARRANTIES OF MERCHANTABILITY AND FITNESS FOR A PARTICULAR PURPOSE ARE DISCLAIMED. IN NO EVENT SHALL THE AUTHOR BE LIABLE FOR ANY DIRECT, INDIRECT, INCIDENTAL, SPECIAL, EXEMPLARY, OR CONSEQUENTIAL DAMAGES (INCLUDING, BUT NOT LIMITED TO, PROCUREMENT OF SUBSTITUTE GOODS OR SERVICES; LOSS OF USE, DATA, OR PROFITS; OR BUSINESS INTERRUPTION) HOWEVER CAUSED AND ON ANY THEORY OF LIABILITY, WHETHER IN CONTRACT, STRICT LIABILITY, OR TORT (INCLUDING NEGLIGENCE OR OTHERWISE) ARISING IN ANY WAY OUT OF THE USE OF THIS SOFTWARE, EVEN IF ADVISED OF THE POSSIBILITY OF SUCH DAMAGE.

(31) - M. Warner Losh (targets using libc/posix)

Copyright (c) 1998, M. Warner Losh <imp@freebsd.org>

All rights reserved.

Redistribution and use in source and binary forms, with or without modification, are permitted provided that the following conditions are met:

1. Redistributions of source code must retain the above copyright notice, this list of conditions and the following disclaimer.
2. Redistributions in binary form must reproduce the above copyright notice, this list of conditions and the following disclaimer in the documentation and/or other materials provided with the distribution.

THIS SOFTWARE IS PROVIDED BY THE AUTHOR AND CONTRIBUTORS "AS IS" AND ANY EXPRESS OR IMPLIED WARRANTIES, INCLUDING, BUT NOT LIMITED TO, THE IMPLIED WARRANTIES OF MERCHANTABILITY AND FITNESS FOR A PARTICULAR PURPOSE ARE DISCLAIMED. IN NO EVENT SHALL THE AUTHOR OR CONTRIBUTORS BE LIABLE FOR ANY DIRECT, INDIRECT, INCIDENTAL, SPECIAL, EXEMPLARY, OR CONSEQUENTIAL DAMAGES (INCLUDING, BUT NOT LIMITED TO, PROCUREMENT OF SUBSTITUTE GOODS OR SERVICES; LOSS OF USE, DATA, OR PROFITS; OR BUSINESS INTERRUPTION) HOWEVER CAUSED AND ON ANY THEORY OF LIABILITY, WHETHER IN CONTRACT, STRICT LIABILITY, OR TORT (INCLUDING NEGLIGENCE OR OTHERWISE) ARISING IN ANY WAY OUT OF THE USE OF THIS SOFTWARE, EVEN IF ADVISED OF THE POSSIBILITY OF SUCH DAMAGE.

(32) - Andrey A. Chernov (targets using libc/posix)

Copyright (C) 1996 by Andrey A. Chernov, Moscow, Russia.

All rights reserved.

Redistribution and use in source and binary forms, with or without modification, are permitted provided that the following conditions are met:

1. Redistributions of source code must retain the above copyright notice, this list of conditions and the following disclaimer.
2. Redistributions in binary form must reproduce the above copyright notice, this list of conditions and the following disclaimer in the documentation and/or other materials provided with the distribution.

THIS SOFTWARE IS PROVIDED BY THE AUTHOR "AS IS" AND ANY EXPRESS OR IMPLIED WARRANTIES, INCLUDING, BUT NOT LIMITED TO, THE IMPLIED WARRANTIES OF MERCHANTABILITY AND FITNESS FOR A PARTICULAR PURPOSE ARE DISCLAIMED. IN NO EVENT SHALL THE REGENTS OR CONTRIBUTORS BE LIABLE FOR ANY DIRECT, INDIRECT, INCIDENTAL, SPECIAL, EXEMPLARY, OR CONSEQUENTIAL DAMAGES (INCLUDING, BUT NOT LIMITED TO, PROCUREMENT OF SUBSTITUTE GOODS OR SERVICES; LOSS OF USE, DATA, OR PROFITS; OR BUSINESS INTERRUPTION) HOWEVER CAUSED AND ON ANY THEORY OF LIABILITY, WHETHER IN CONTRACT, STRICT LIABILITY, OR TORT (INCLUDING NEGLIGENCE OR OTHERWISE) ARISING IN ANY WAY OUT OF THE USE OF THIS SOFTWARE, EVEN IF ADVISED OF THE POSSIBILITY OF SUCH DAMAGE.

(33) - Daniel Eischen (targets using libc/posix)

Copyright (c) 2001 Daniel Eischen <deischen@FreeBSD.org>.

All rights reserved.

Redistribution and use in source and binary forms, with or without modification, are permitted provided that the following conditions are met:

1. Redistributions of source code must retain the above copyright notice, this list of conditions and the following disclaimer.
2. Redistributions in binary form must reproduce the above copyright notice, this list of conditions and the following disclaimer in the documentation and/or other materials provided with the distribution.

THIS SOFTWARE IS PROVIDED BY THE AUTHOR AND CONTRIBUTORS "AS IS" AND ANY EXPRESS OR IMPLIED WARRANTIES, INCLUDING, BUT NOT LIMITED TO, THE IMPLIED WARRANTIES OF MERCHANTABILITY AND FITNESS FOR A PARTICULAR PURPOSE ARE DISCLAIMED. IN NO EVENT SHALL THE REGENTS OR CONTRIBUTORS BE LIABLE FOR ANY DIRECT, INDIRECT, INCIDENTAL, SPECIAL, EXEMPLARY, OR CONSEQUENTIAL DAMAGES (INCLUDING, BUT NOT LIMITED TO, PROCUREMENT OF SUBSTITUTE GOODS OR SERVICES; LOSS OF USE, DATA, OR PROFITS; OR BUSINESS INTERRUPTION) HOWEVER CAUSED AND ON

ANY THEORY OF LIABILITY, WHETHER IN CONTRACT, STRICT LIABILITY, OR TORT (INCLUDING NEGLIGENCE OR OTHERWISE) ARISING IN ANY WAY OUT OF THE USE OF THIS SOFTWARE, EVEN IF ADVISED OF THE POSSIBILITY OF SUCH DAMAGE.

(35) - ARM Ltd (arm and thumb variant targets only)

Copyright (c) 2009 ARM Ltd

All rights reserved.

Redistribution and use in source and binary forms, with or without modification, are permitted provided that the following conditions are met:

1. Redistributions of source code must retain the above copyright notice, this list of conditions and the following disclaimer.
2. Redistributions in binary form must reproduce the above copyright notice, this list of conditions and the following disclaimer in the documentation and/or other materials provided with the distribution.
3. The name of the company may not be used to endorse or promote products derived from this software without specific prior written permission.

THIS SOFTWARE IS PROVIDED BY ARM LTD "AS IS" AND ANY EXPRESS OR IMPLIED WARRANTIES, INCLUDING, BUT NOT LIMITED TO, THE IMPLIED WARRANTIES OF MERCHANTABILITY AND FITNESS FOR A PARTICULAR PURPOSE ARE DISCLAIMED. IN NO EVENT SHALL ARM LTD BE LIABLE FOR ANY DIRECT, INDIRECT, INCIDENTAL, SPECIAL, EXEMPLARY, OR CONSEQUENTIAL DAMAGES (INCLUDING, BUT NOT LIMITED TO, PROCUREMENT OF SUBSTITUTE GOODS OR SERVICES; LOSS OF USE, DATA, OR PROFITS; OR BUSINESS INTERRUPTION) HOWEVER CAUSED AND ON ANY THEORY OF LIABILITY, WHETHER IN CONTRACT, STRICT LIABILITY, OR TORT (INCLUDING NEGLIGENCE OR OTHERWISE) ARISING IN ANY WAY OUT OF THE USE OF THIS SOFTWARE, EVEN IF ADVISED OF THE POSSIBILITY OF SUCH DAMAGE.

(36) - CodeSourcery, Inc.

Copyright (c) 2009 CodeSourcery, Inc.

All rights reserved.

Redistribution and use in source and binary forms, with or without modification, are permitted provided that the following conditions are met:

- * Redistributions of source code must retain the above copyright notice, this list of conditions and the following disclaimer.
- * Redistributions in binary form must reproduce the above copyright notice, this list of conditions and the following disclaimer in the documentation and/or other materials provided with the distribution.

* Neither the name of CodeSourcery nor the names of its contributors may be used to endorse or promote products derived from this software without specific prior written permission.

THIS SOFTWARE IS PROVIDED BY CODESOURCERY, INC. "AS IS" AND ANY EXPRESS OR IMPLIED WARRANTIES, INCLUDING, BUT NOT LIMITED TO, THE IMPLIED WARRANTIES OF MERCHANTABILITY AND FITNESS FOR A PARTICULAR PURPOSE ARE DISCLAIMED. IN NO EVENT SHALL CODESOURCERY BE LIABLE FOR ANY DIRECT, INDIRECT, INCIDENTAL, SPECIAL, EXEMPLARY, OR CONSEQUENTIAL DAMAGES (INCLUDING, BUT NOT LIMITED TO, PROCUREMENT OF SUBSTITUTE GOODS OR SERVICES; LOSS OF USE, DATA, OR PROFITS; OR BUSINESS INTERRUPTION) HOWEVER CAUSED AND ON ANY THEORY OF LIABILITY, WHETHER IN CONTRACT, STRICT LIABILITY, OR TORT (INCLUDING NEGLIGENCE OR OTHERWISE) ARISING IN ANY WAY OUT OF THE USE OF THIS SOFTWARE, EVEN IF ADVISED OF THE POSSIBILITY OF SUCH DAMAGE.

(37) MIPS Technologies, Inc

/*

* Copyright (c) 2009 MIPS Technologies, Inc.

* All rights reserved.

* Redistribution and use in source and binary forms, with or without modification, are permitted provided that the following conditions are met:

* * Redistributions of source code must retain the above copyright notice, this list of conditions and the following disclaimer.

* * Redistributions in binary form must reproduce the above copyright notice, this list of conditions and the following disclaimer in the documentation and/or other materials provided with the distribution.

* * Neither the name of MIPS Technologies Inc. nor the names of its contributors may be used to endorse or promote products derived from this software without specific prior written permission.

* THIS SOFTWARE IS PROVIDED BY THE COPYRIGHT HOLDERS AND CONTRIBUTORS "AS IS" AND ANY EXPRESS OR IMPLIED WARRANTIES, INCLUDING, BUT NOT LIMITED TO, THE IMPLIED WARRANTIES OF MERCHANTABILITY AND FITNESS FOR A PARTICULAR PURPOSE ARE DISCLAIMED. IN NO EVENT SHALL THE COPYRIGHT OWNER OR CONTRIBUTORS BE LIABLE FOR ANY DIRECT, INDIRECT, INCIDENTAL, SPECIAL, EXEMPLARY, OR CONSEQUENTIAL DAMAGES (INCLUDING, BUT NOT LIMITED TO, PROCUREMENT OF SUBSTITUTE GOODS OR SERVICES; LOSS OF USE, DATA, OR PROFITS; OR BUSINESS INTERRUPTION) HOWEVER CAUSED AND ON ANY THEORY OF LIABILITY, WHETHER IN CONTRACT, STRICT LIABILITY, OR TORT (INCLUDING NEGLIGENCE OR OTHERWISE) ARISING IN ANY WAY OUT OF THE USE OF THIS SOFTWARE, EVEN IF ADVISED OF THE POSSIBILITY OF SUCH DAMAGE.

*/

MIT License

This projector product includes the open source software program which applies the terms and conditions provided by owner of the copyright to the "MIT License".

The "MIT License" are WITHOUT ANY WARRANTY; without even the implied warranty of MERCHANTABILITY AND FITNESS FOR A PARTICULAR PURPOSE.

List of MIT License programs

- jquery-1.7.2.min.js
- jquery-ui-1.8.20
- jquery.ui.touch-punch.js
- jquery.upload-1.0.2.min.js
- jquery-1.11.3.min.js
- jquery-ui-1.11.4
- normalize.css

License terms of conditions of each program which are provided by owner of the copyright to the "MIT License" are as follows.

Copyright (c) 2012 jQuery Foundation and other contributors,

<http://jquery.com/>

Copyright (c) Nicolas Gallagher and Jonathan Neal

Permission is hereby granted, free of charge, to any person obtaining a copy of this software and associated documentation files (the "Software"), to deal in the Software without restriction, including without limitation the rights to use, copy, modify, merge, publish, distribute, sublicense, and/or sell copies of the Software, and to permit persons to whom the Software is furnished to do so, subject to the following conditions:

The above copyright notice and this permission notice shall be included in all copies or substantial portions of the Software.

THE SOFTWARE IS PROVIDED "AS IS", WITHOUT WARRANTY OF ANY KIND, EXPRESS OR IMPLIED, INCLUDING BUT NOT LIMITED TO THE WARRANTIES OF MERCHANTABILITY, FITNESS FOR A PARTICULAR PURPOSE AND NONINFRINGEMENT. IN NO EVENT SHALL THE AUTHORS OR COPYRIGHT HOLDERS BE LIABLE FOR ANY CLAIM, DAMAGES OR OTHER LIABILITY, WHETHER IN AN ACTION OF CONTRACT, TORT OR OTHERWISE, ARISING FROM, OUT OF OR IN CONNECTION WITH THE SOFTWARE OR THE USE OR OTHER DEALINGS IN THE SOFTWARE.

TOPPERS/JSP

This projector product includes the open source software program "TOPPERS/JSP" which applies the terms and conditions provided by owner of the copyright to the "TOPPERS/JSP".

The "TOPPERS/JSP" are WITHOUT ANY WARRANTY; without even the implied warranty of MERCHANTABILITY AND FITNESS FOR A PARTICULAR PURPOSE.

List of TOPPERS/JSP programs

- jsp-1.4.3

License terms of conditions of each program which are provided by owner of the copyright to the "TOPPERS/JSP" are as follows.

TOPPERS/JSP Kernel

Toyohashi Open Platform for Embedded Real-Time Systems/Just Standard Profile Kernel

Copyright (C) 2000-2003 by Embedded and Real-Time Systems Laboratory Toyohashi Univ. of Technology, JAPAN

Copyright (C) 2004 by Embedded and Real-Time Systems Laboratory Graduate School of Information Science, Nagoya Univ., JAPAN.

The above copyright holder, limited to cases in which one satisfies conditions (1) ~ (4) below, or the conditions described in Version 2 of the GNU Public License officially announced by the Free Software Foundation, consents to the use, reproduction, alteration, and redistribution (hereafter called utilization) of this software (this software includes alterations, likewise below) without compensation.

(1) When this software is utilized in the form of source code, the above copyright declaration, these conditions of utilization, and the following stipulation of no guarantee shall be included in unchanged form inside the source code.

(2) When this software is redistributed in a form in which it can be used in the development of other software, library form, etc., the above copyright display, these terms of utilization, and the following stipulation of no guarantee shall be inserted in documentation accompanying redistribution (user's manual, etc.).

(3) When this software is redistributed in a form in which it cannot be used in the development of other software, embedded in devices, etc., one of the following conditions shall be satisfied.

(a) The above copyright display, these terms of utilization, and the following stipulation of no guarantee shall be inserted in documentation accompanying redistribution (user's manual, etc.).

(b) The TOPPERS Project shall be notified owing to a method in which the form of distribution is decided otherwise.

(4) The above copyright holder and the TOPPERS Project shall be exempt from responsibility for whatever damages occur either directly or indirectly through the utilization of this software.

This software is something that is provided with no guarantee. The above copyright holder and the TOPPERS Project make no guarantee whatsoever in regard to this software, including the possibility of its application. In addition, the above copyright holder and the TOPPERS Project shall also not bear responsibility for whatever damages occur either directly or indirectly through the utilization of this software.

Note: The TOPPERS License has been revised several times; what is shown above is the latest version that is to be applied to software made public hereafter.

TINET

This projector product includes the open source software program "TINET" which applies the terms and conditions provided by owner of the copyright to the "TINET".

The "TINET" are WITHOUT ANY WARRANTY; without even the implied warranty of MERCHANTABILITY AND FITNESS FOR A PARTICULAR PURPOSE.

List of TINET programs

- tinet-1.4.4

License terms of conditions of each program which are provided by owner of the copyright to the "TINET" are as follows.

(1) FreeBSD

Copyright (c) 1980, 1986, 1993

The Regents of the University of California. All rights reserved.

Redistribution and use in source and binary forms, with or without modification, are permitted provided that the following conditions are met:

1. Redistributions of source code must retain the above copyright notice, this list of conditions and the following disclaimer.
2. Redistributions in binary form must reproduce the above copyright notice, this list of conditions and the following disclaimer in the documentation and/or other materials provided with the distribution.
3. All advertising materials mentioning features or use of this software must display the following acknowledgement:

This product includes software developed by the University of California, Berkeley and its contributors.

4. Neither the name of the University nor the names of its contributors may be used to endorse or promote products derived from this software without specific prior written permission.

THIS SOFTWARE IS PROVIDED BY THE REGENTS AND CONTRIBUTORS "AS IS" AND ANY EXPRESS OR IMPLIED WARRANTIES, INCLUDING, BUT NOT LIMITED TO, THE IMPLIED WARRANTIES OF MERCHANTABILITY AND FITNESS FOR A PARTICULAR PURPOSE ARE DISCLAIMED. IN NO EVENT SHALL THE REGENTS OR CONTRIBUTORS BE LIABLE FOR ANY DIRECT, INDIRECT, INCIDENTAL, SPECIAL, EXEMPLARY, OR CONSEQUENTIAL DAMAGES (INCLUDING, BUT NOT LIMITED TO, PROCUREMENT OF SUBSTITUTE GOODS OR SERVICES; LOSS OF USE, DATA, OR PROFITS; OR BUSINESS INTERRUPTION) HOWEVER CAUSED AND ON ANY THEORY OF LIABILITY, WHETHER IN CONTRACT, STRICT LIABILITY, OR TORT (INCLUDING NEGLIGENCE OR OTHERWISE) ARISING IN ANY WAY OUT OF THE USE OF THIS SOFTWARE, EVEN IF ADVISED OF THE POSSIBILITY OF SUCH DAMAGE.

(6) TINET and TOPPERS

TINET (TCP/IP Protocol Stack)

Copyright (C) 2001-2006 by Dep. of Computer Science and Engineering Tomakomai National College of Technology, JAPAN

The above copyright holder, limited to cases in which one satisfies conditions (1) ~ (4) below, or the conditions described in Version 2 of the GNU Public License officially announced by the Free Software Foundation, consents to the use, reproduction, alteration, and redistribution (hereafter called utilization) of this software (this software includes alterations, likewise below) without compensation.

(1) When this software is utilized in the form of source code, the above copyright declaration, these conditions of utilization, and the following stipulation of no guarantee shall be included in unchanged form inside the source code.

(2) When this software is redistributed in a form in which it can be used in the development of other software, library form, etc., the above copyright display, these terms of utilization, and the following stipulation of no guarantee shall be inserted in documentation accompanying redistribution (user's manual, etc.).

(3) When this software is redistributed in a form in which it cannot be used in the development of other software, embedded in devices, etc., following conditions shall be satisfied.

(a) The above copyright display, these terms of utilization, and the following stipulation of no guarantee shall be inserted in documentation accompanying redistribution (user's manual, etc.).

(4) The above copyright holder and the TOPPERS Project shall be exempt from responsibility for whatever damages occur either directly or indirectly through the utilization of this software.

This software is something that is provided with no guarantee. The above copyright holder and the TOPPERS Project make no guarantee whatsoever in regard to this software, including the possibility of its application. In addition, the above copyright holder and the TOPPERS Project shall also not bear responsibility for whatever damages occur either directly or indirectly through the utilization of this software.

WPA Supplicant

This projector product includes the open source software program which applies the terms and conditions provided by owner of the copyright to the "WPA Supplicant".

The "WPA Supplicant" are WITHOUT ANY WARRANTY; without even the implied warranty of MERCHANTABILITY AND FITNESS FOR A PARTICULAR PURPOSE.

List of WPA Supplicant programs

- wpa_supplicant-2.3

License terms of conditions of each program which are provided by owner of the copyright to the "WPA Supplicant" are as follows.

Copyright (c) 2003-2014, Jouni Malinen <j@w1.fi> and contributors

All Rights Reserved.

This program is licensed under the BSD license (the one with advertisement clause removed).

If you are submitting changes to the project, please see CONTRIBUTIONS file for more instructions.

License

This software may be distributed, used, and modified under the terms of BSD license:

Redistribution and use in source and binary forms, with or without modification, are permitted provided that the following conditions are met:

1. Redistributions of source code must retain the above copyright notice, this list of conditions and the following disclaimer.
2. Redistributions in binary form must reproduce the above copyright notice, this list of conditions and the following disclaimer in the documentation and/or other materials provided with the distribution.
3. Neither the name(s) of the above-listed copyright holder(s) nor the names of its contributors may be used to endorse or promote products derived from this software without specific prior written permission.

THIS SOFTWARE IS PROVIDED BY THE COPYRIGHT HOLDERS AND CONTRIBUTORS "AS IS" AND ANY EXPRESS OR IMPLIED WARRANTIES, INCLUDING, BUT NOT LIMITED TO, THE IMPLIED WARRANTIES OF MERCHANTABILITY AND FITNESS FOR A PARTICULAR PURPOSE ARE DISCLAIMED. IN NO EVENT SHALL THE COPYRIGHT OWNER OR CONTRIBUTORS BE LIABLE FOR ANY DIRECT, INDIRECT, INCIDENTAL, SPECIAL, EXEMPLARY, OR CONSEQUENTIAL DAMAGES (INCLUDING, BUT NOT LIMITED TO, PROCUREMENT OF SUBSTITUTE GOODS OR SERVICES; LOSS OF USE, DATA, OR PROFITS; OR BUSINESS INTERRUPTION) HOWEVER CAUSED AND ON ANY THEORY OF LIABILITY, WHETHER IN CONTRACT, STRICT LIABILITY, OR

TORT (INCLUDING NEGLIGENCE OR OTHERWISE) ARISING IN ANY WAY OUT OF THE USE OF THIS SOFTWARE, EVEN IF ADVISED OF THE POSSIBILITY OF SUCH DAMAGE.

lighttpd

This projector product includes the open source software program "lighttpd" which applies the terms and conditions provided by owner of the copyright to the "lighttpd".

The "lighttpd" are WITHOUT ANY WARRANTY; without even the implied warranty of MERCHANTABILITY AND FITNESS FOR A PARTICULAR PURPOSE.

List of lighttpd programs

- lighttpd-1.4.35

License terms of conditions of each program which are provided by owner of the copyright to the "lighttpd" are as follows.

Copyright (c) 2004, Jan Kneschke, incremental

All rights reserved.

Redistribution and use in source and binary forms, with or without modification, are permitted provided that the following conditions are met:

- Redistributions of source code must retain the above copyright notice, this list of conditions and the following disclaimer.
- Redistributions in binary form must reproduce the above copyright notice, this list of conditions and the following disclaimer in the documentation and/or other materials provided with the distribution.
- Neither the name of the 'incremental' nor the names of its contributors may be used to endorse or promote products derived from this software without specific prior written permission.

THIS SOFTWARE IS PROVIDED BY THE COPYRIGHT HOLDERS AND CONTRIBUTORS "AS IS" AND ANY EXPRESS OR IMPLIED WARRANTIES, INCLUDING, BUT NOT LIMITED TO, THE IMPLIED WARRANTIES OF MERCHANTABILITY AND FITNESS FOR A PARTICULAR PURPOSE ARE DISCLAIMED. IN NO EVENT SHALL THE COPYRIGHT OWNER OR CONTRIBUTORS BE LIABLE FOR ANY DIRECT, INDIRECT, INCIDENTAL, SPECIAL, EXEMPLARY, OR CONSEQUENTIAL DAMAGES (INCLUDING, BUT NOT LIMITED TO, PROCUREMENT OF SUBSTITUTE GOODS OR SERVICES; LOSS OF USE, DATA, OR PROFITS; OR BUSINESS INTERRUPTION) HOWEVER CAUSED AND ON ANY THEORY OF LIABILITY, WHETHER IN CONTRACT, STRICT LIABILITY, OR TORT (INCLUDING NEGLIGENCE OR OTHERWISE) ARISING IN ANY WAY OUT OF THE USE OF THIS SOFTWARE, EVEN IF ADVISED OF THE POSSIBILITY OF SUCH DAMAGE

PCRE

This projector product includes the open source software program "PCRE" which applies the terms and conditions provided by owner of the copyright to the "PCRE".

The "PCRE" are WITHOUT ANY WARRANTY; without even the implied warranty of MERCHANTABILITY AND FITNESS FOR A PARTICULAR PURPOSE.

List of PCRE programs

- pcre-8.32

License terms of conditions of each program which are provided by owner of the copyright to the "PCRE" are as follows.

PCRE LICENCE

PCRE is a library of functions to support regular expressions whose syntax and semantics are as close as possible to those of the Perl 5 language.

Release 8 of PCRE is distributed under the terms of the "BSD" licence, as specified below. The documentation for PCRE, supplied in the "doc" directory, is distributed under the same terms as the software itself.

The basic library functions are written in C and are freestanding. Also included in the distribution is a set of C++ wrapper functions, and a just-in-time compiler that can be used to optimize pattern matching. These are both optional features that can be omitted when the library is built.

THE BASIC LIBRARY FUNCTIONS

Written by: Philip Hazel

Email local part: ph10

Email domain: cam.ac.uk

University of Cambridge Computing Service, Cambridge, England.

Copyright (c) 1997-2012 University of Cambridge

All rights reserved.

PCRE JUST-IN-TIME COMPILATION SUPPORT

Written by: Zoltan Herczeg

Email local part: hzmester
Email domain: freemail.hu
Copyright(c) 2010-2012 Zoltan Herczeg
All rights reserved.

STACK-LESS JUST-IN-TIME COMPILER

Written by: Zoltan Herczeg
Email local part: hzmester
Email domain: freemail.hu
Copyright(c) 2009-2012 Zoltan Herczeg
All rights reserved.

THE C++ WRAPPER FUNCTIONS

Contributed by: Google Inc.
Copyright (c) 2007-2012, Google Inc.
All rights reserved.

THE "BSD" LICENCE

Redistribution and use in source and binary forms, with or without modification, are permitted provided that the following conditions are met:

- * Redistributions of source code must retain the above copyright notice, this list of conditions and the following disclaimer.
- * Redistributions in binary form must reproduce the above copyright notice, this list of conditions and the following disclaimer in the documentation and/or other materials provided with the distribution.
- * Neither the name of the University of Cambridge nor the name of Google Inc. nor the names of their contributors may be used to endorse or promote products derived from this software without specific prior written permission.

THIS SOFTWARE IS PROVIDED BY THE COPYRIGHT HOLDERS AND CONTRIBUTORS "AS IS"
AND ANY EXPRESS OR IMPLIED WARRANTIES, INCLUDING, BUT NOT LIMITED TO, THE IMPLIED

WARRANTIES OF MERCHANTABILITY AND FITNESS FOR A PARTICULAR PURPOSE ARE DISCLAIMED. IN NO EVENT SHALL THE COPYRIGHT OWNER OR CONTRIBUTORS BE LIABLE FOR ANY DIRECT, INDIRECT, INCIDENTAL, SPECIAL, EXEMPLARY, OR CONSEQUENTIAL DAMAGES (INCLUDING, BUT NOT LIMITED TO, PROCUREMENT OF SUBSTITUTE GOODS OR SERVICES; LOSS OF USE, DATA, OR PROFITS; OR BUSINESS INTERRUPTION) HOWEVER CAUSED AND ON ANY THEORY OF LIABILITY, WHETHER IN CONTRACT, STRICT LIABILITY, OR TORT (INCLUDING NEGLIGENCE OR OTHERWISE) ARISING IN ANY WAY OUT OF THE USE OF THIS SOFTWARE, EVEN IF ADVISED OF THE POSSIBILITY OF SUCH DAMAGE.

End

FastCGI

This projector product includes the open source software program "FastCGI" which applies the terms and conditions provided by owner of the copyright to the "FastCGI"

The "FastCGI" are WITHOUT ANY WARRANTY; without even the implied warranty of MERCHANTABILITY AND FITNESS FOR A PARTICULAR PURPOSE.

List of FastCGI programs

- fcgi-2.4.0

License terms of conditions of each program which are provided by owner of the copyright to the "FastCGI" are as follows.

This FastCGI application library source and object code (the "Software") and its documentation (the "Documentation") are copyrighted by Open Market, Inc ("Open Market"). The following terms apply to all files associated with the Software and Documentation unless explicitly disclaimed in individual files.

Open Market permits you to use, copy, modify, distribute, and license this Software and the Documentation for any purpose, provided that existing copyright notices are retained in all copies and that this notice is included verbatim in any distributions. No written agreement, license, or royalty fee is required for any of the authorized uses. Modifications to this Software and Documentation may be copyrighted by their authors and need not follow the licensing terms described here. If modifications to this Software and Documentation have new licensing terms, the new terms must be clearly indicated on the first page of each file where they apply.

OPEN MARKET MAKES NO EXPRESS OR IMPLIED WARRANTY WITH RESPECT TO THE SOFTWARE OR THE DOCUMENTATION, INCLUDING WITHOUT LIMITATION ANY WARRANTY OF MERCHANTABILITY OR FITNESS FOR A PARTICULAR PURPOSE. IN NO EVENT SHALL OPEN MARKET BE LIABLE TO YOU OR ANY THIRD PARTY FOR ANY DAMAGES ARISING FROM OR RELATING TO THIS SOFTWARE OR THE DOCUMENTATION, INCLUDING, WITHOUT LIMITATION, ANY INDIRECT, SPECIAL OR CONSEQUENTIAL DAMAGES OR SIMILAR DAMAGES, INCLUDING LOST PROFITS OR LOST DATA, EVEN IF OPEN MARKET HAS BEEN ADVISED OF THE POSSIBILITY OF SUCH DAMAGES. THE SOFTWARE AND DOCUMENTATION ARE PROVIDED "AS

IS". OPEN MARKET HAS NO LIABILITY IN CONTRACT, TORT, NEGLIGENCE OR OTHERWISE ARISING OUT OF THIS SOFTWARE OR THE DOCUMENTATION.

D3.js

This projector product includes the open source software program "D3.js" which applies the terms and conditions provided by owner of the copyright to the "D3.js"

The "D3.js" are WITHOUT ANY WARRANTY; without even the implied warranty of MERCHANTABILITY AND FITNESS FOR A PARTICULAR PURPOSE.

List of D3.js programs:

d3.js

License terms of conditions of each program which are provided by owner of the copyright to the "D3.js" are as follows.

Copyright (c) 2010-2016, Michael Bostock

All rights reserved.

Redistribution and use in source and binary forms, with or without modification, are permitted provided that the following conditions are met:

- * Redistributions of source code must retain the above copyright notice, this list of conditions and the following disclaimer.
- * Redistributions in binary form must reproduce the above copyright notice, this list of conditions and the following disclaimer in the documentation and/or other materials provided with the distribution.
- * The name Michael Bostock may not be used to endorse or promote products derived from this software without specific prior written permission.

THIS SOFTWARE IS PROVIDED BY THE COPYRIGHT HOLDERS AND CONTRIBUTORS "AS IS" AND ANY EXPRESS OR IMPLIED WARRANTIES, INCLUDING, BUT NOT LIMITED TO, THE IMPLIED WARRANTIES OF MERCHANTABILITY AND FITNESS FOR A PARTICULAR PURPOSE ARE DISCLAIMED. IN NO EVENT SHALL MICHAEL BOSTOCK BE LIABLE FOR ANY DIRECT, INDIRECT, INCIDENTAL, SPECIAL, EXEMPLARY, OR CONSEQUENTIAL DAMAGES (INCLUDING, BUT NOT LIMITED TO, PROCUREMENT OF SUBSTITUTE GOODS OR SERVICES; LOSS OF USE, DATA, OR PROFITS; OR BUSINESS INTERRUPTION) HOWEVER CAUSED AND ON ANY THEORY OF LIABILITY, WHETHER IN CONTRACT, STRICT LIABILITY, OR TORT (INCLUDING NEGLIGENCE OR OTHERWISE) ARISING IN ANY WAY OUT OF THE USE OF THIS SOFTWARE, EVEN IF ADVISED OF THE POSSIBILITY OF SUCH DAMAGE.

Parent topic: [Notices](#)

Trademarks

EPSON®, EasyMP®, Instant Off®, and Quick Corner® are registered trademarks, and EPSON Exceed Your Vision is a registered logomark of Seiko Epson Corporation.

PrivateLine® is a registered trademark; SizeWise™ is a trademark; and Epson StoreSM and Extra CareSM are service marks of Epson America, Inc.

Mac and OS X are trademarks of Apple Inc., registered in the U.S. and other countries.

HDMI and High-Definition Multimedia Interface are the trademarks or registered trademarks of HDMI Licensing LLC.  HIGH DEFINITION MULTIMEDIA INTERFACE

HDBaseT™ and the HDBaseT Alliance logo are trademarks of the HDBaseT Alliance.

General Notice: Other product names used herein are for identification purposes only and may be trademarks of their respective owners. Epson disclaims any and all rights in those marks.



Parent topic: [Notices](#)

Copyright Notice

All rights reserved. No part of this publication may be reproduced, stored in a retrieval system, or transmitted in any form or by any means, electronic, mechanical, photocopying, recording, or otherwise, without the prior written permission of Seiko Epson Corporation. The information contained herein is designed only for use with this Epson product. Epson is not responsible for any use of this information as applied to other products.

Neither Seiko Epson Corporation nor its affiliates shall be liable to the purchaser of this product or third parties for damages, losses, costs, or expenses incurred by purchaser or third parties as a result of: accident, misuse, or abuse of this product or unauthorized modifications, repairs, or alterations to this product, or (excluding the U.S.) failure to strictly comply with Seiko Epson Corporation's operating and maintenance instructions.

Seiko Epson Corporation shall not be liable for any damages or problems arising from the use of any options or any consumable products other than those designated as Original Epson Products or Epson Approved Products by Seiko Epson Corporation.

This information is subject to change without notice.

[A Note Concerning Responsible Use of Copyrighted Materials](#)

[Copyright Attribution](#)

Parent topic: [Notices](#)

A Note Concerning Responsible Use of Copyrighted Materials

Epson encourages each user to be responsible and respectful of the copyright laws when using any Epson product. While some countries' laws permit limited copying or reuse of copyrighted material in certain circumstances, those circumstances may not be as broad as some people assume. Contact your legal advisor for any questions regarding copyright law.

Parent topic: [Copyright Notice](#)

Copyright Attribution

© 2016 Epson America, Inc.

7/16

CPD-51321R1

Parent topic: [Copyright Notice](#)